

# TEM

OnOff and everything in between

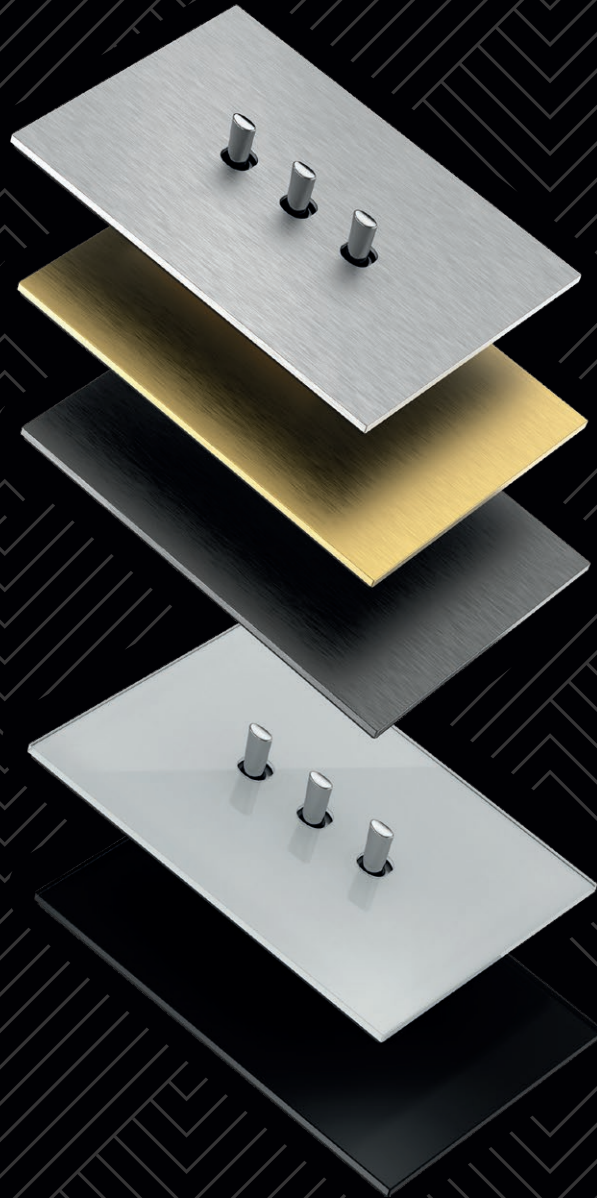

2024





# MODUL



MODUL  
LINE



MODUL  
SOFT



MODUL  
PURE



MODUL  
EDGE

50

# LOGIQ



LOGIQ  
BOLD



LOGIQ  
FLAT



LOGIQ  
PRIME

178

# ekonomik



222

# fontana



260



# TEM

On | Off and everything in between



Ne jemi një kompani prodhuese e çelësave dhe prizave që ofrojmë një eksperiencë pozitive dhe të lehtë për përdoruesit, ndërkohë që plotësojmë nevojat më kërkuese të çdo përdoruesi dhe hapësire me produkte që janë të lehta për t'u instaluar dhe përdorur, si dhe një gamë të gjerë ngjyrash dhe materialesh.

*We are a manufacturer of switches and sockets offering a positive and easy user experience while satisfying the most demanding needs of every user and space with products that are easy to install and use, as well as a wide range of colours and materials.*

# TEM

## Mirë se vini në familjen MODUL

Welcome to the MODUL family

Jepini ambientit tuaj një ndjesi personale dhe tregoni stilin tuaj me çelësat dhe prizat e familjes MODUL.

*Give your ambience a personal touch and show off your style with switches and sockets from MODUL family.*

## zbulojmë ide të reja

discovering new insights



MODUL  

---

LINE



MODUL  

---

SOFT



MODUL  

---

PURE



MODUL  

---

EDGE

1

2

MODUL  
LINE



MODUL  
SOFT



MODUL  
PURE

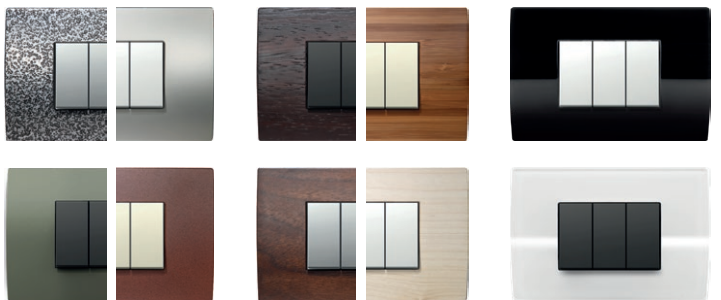

metal

dru

xham

MODUL  
EDGE

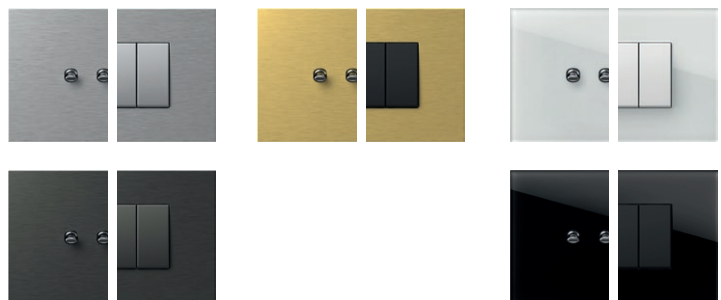

metal

metal

xham

3

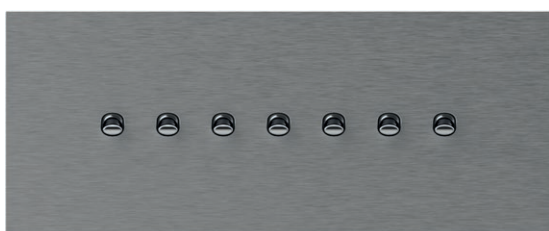

4

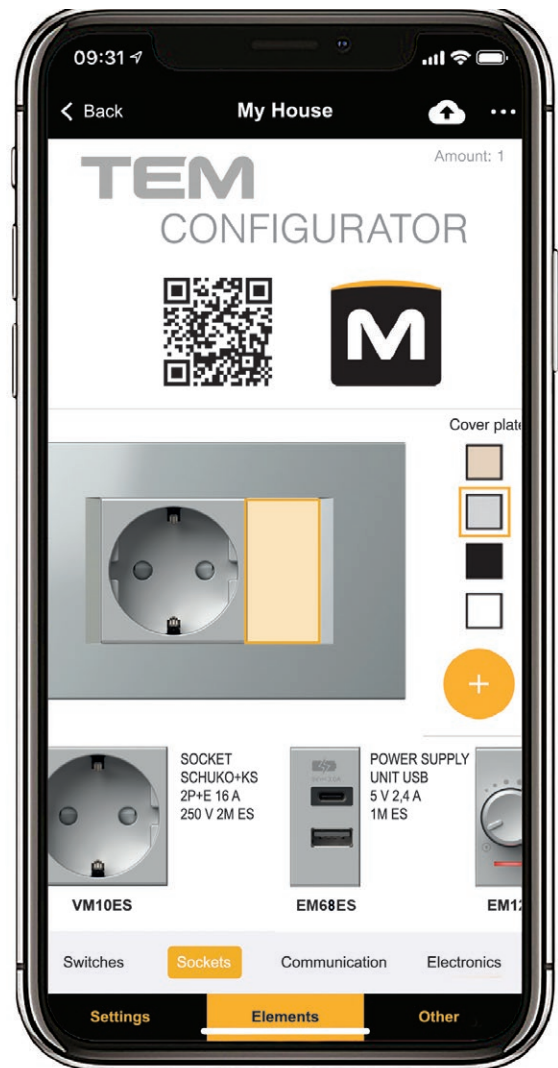



MODUL

LINE



Linjat e drejta dhe të lëmuara krijojnë një dizajn klasik.

*Straight, smooth lines create a timeless design.*









MODUL

LINE

PW



e bardhë  
polare  
*polar white*

MW



e bardhë  
mat  
*matte white*

IW



e bardhë  
fildishi  
*ivory white*

ES



e argjendtë  
elox  
*elox silver*

AT

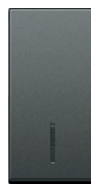

antracit  
*anthracite*

SB

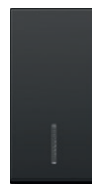

e zezë soft  
touch  
*soft touch  
black*

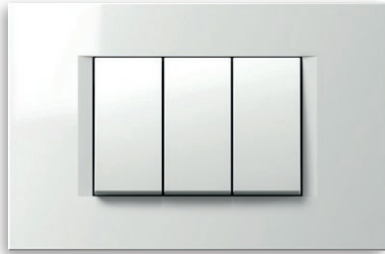

PW e bardhë polare  
*polar white*

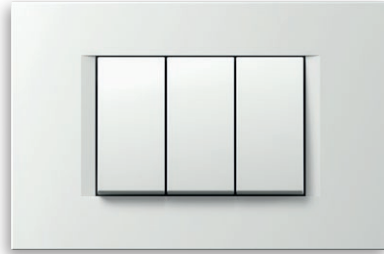

MW e bardhë mat  
*matte white*

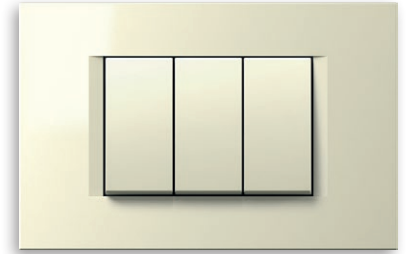

IW e bardhë fildishi  
*ivory white*



SW e bardhë guri  
*stone white*



ES e argjendtë elox  
*elox silver*

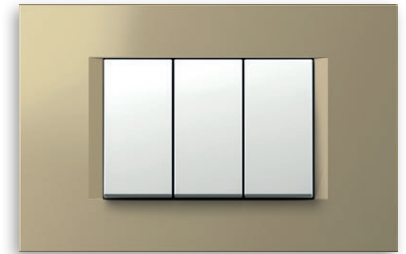

SG e artë ranore  
*sand gold*



TI titan  
*titanium*

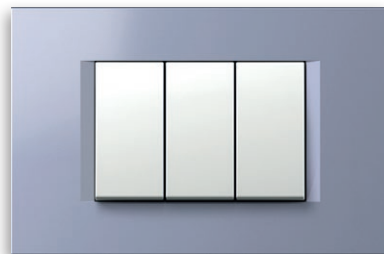

IB blu impulse  
*impulse blue*



AT antracit  
*anthracite*



NB e zezë nate  
*night black*

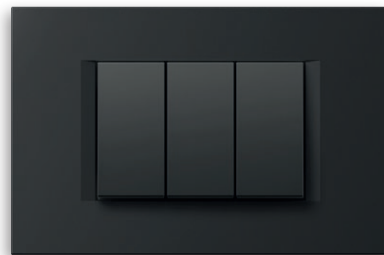

SB e zezë soft touch  
*soft touch black*

MODUL

SOFT

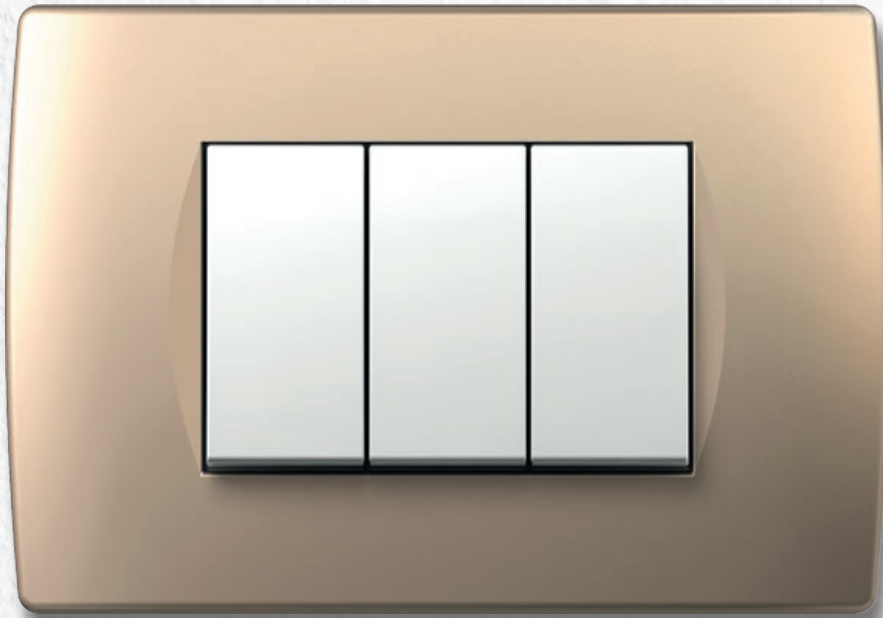

Format e rrumbullakëta dhe pjesët bashkuese të lëmuara sjellin butësi në shtëpinë tuaj.

*Rounded shapes and soft transitions bring softness into your home.*









MODUL

SOFT

PW



e bardhë  
polare  
*polar white*

MW



e bardhë  
mat  
*matte white*

IW



e bardhë  
fildishi  
*ivory white*

ES



e argjendtë  
elox  
*elox silver*

AT

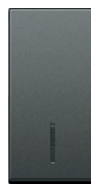

antracit  
*anthracite*

SB

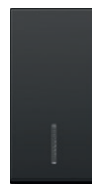

e zezë soft  
touch  
*soft touch  
black*

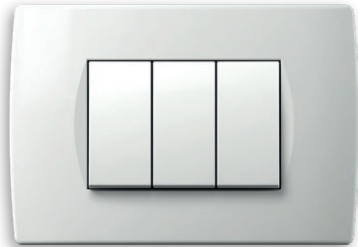

PW e bardhë polare  
*polar white*

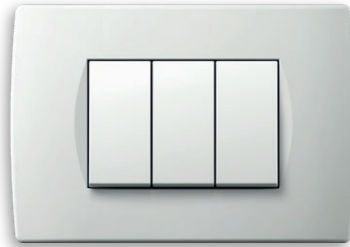

MW e bardhë mat  
*matte white*

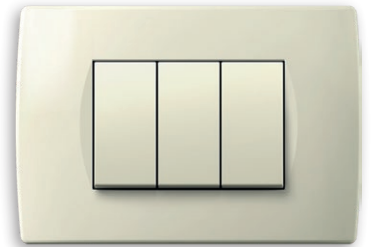

IW e bardhë fildishi  
*ivory white*



ES e argjendtë elox  
*elox silver*

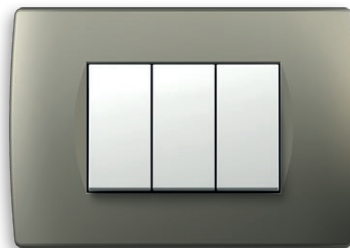

TI titan  
*titanium*

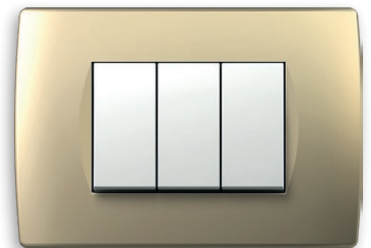

SG e artë ranore  
*sand gold*



WW arrë  
*walnut*



WE venge  
*wenge*



AT antracit  
*anthracite*



NB e zezë nate  
*night black*



SB e zezë soft touch  
*soft touch black*

MODUL

PURE

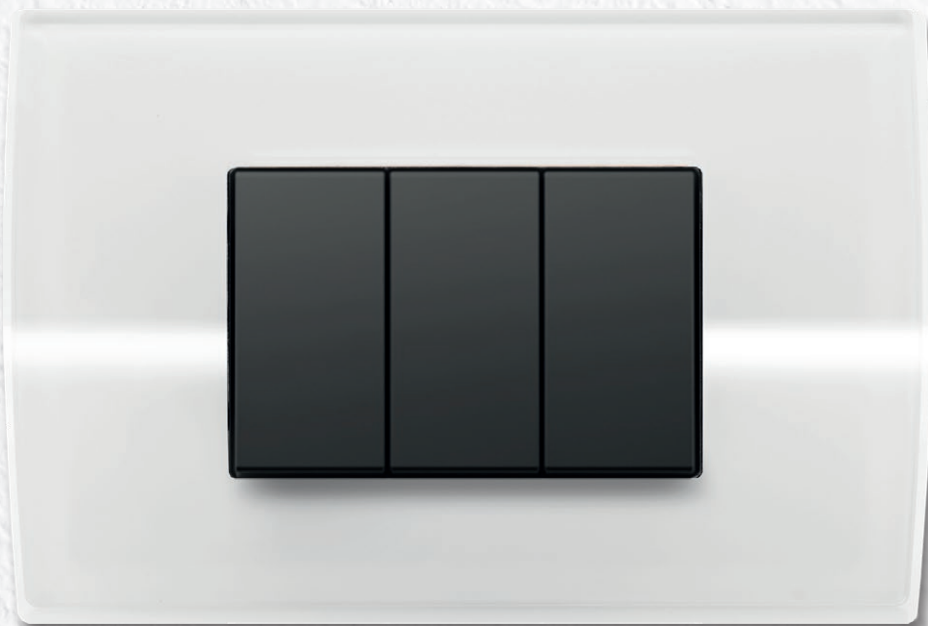

Detajet përfaqësojnë plotësimin e të gjithë ambientit tuaj. Lëreni natyrën të pasurojë hapësirën tuaj me kapakë mbulues dekorativë prej druri, xhami dhe metali.

*The details represent the completeness of the entire ambience. Let the nature enrich your space with decorative cover plates made of wood, glass and metal.*







MODUL

PURE

PW	MW	IW	ES	AT	SB
					
e bardhë polare	e bardhë mat	e bardhë fildishi	e argjendë elox	antracit	e zezë soft touch
<i>polar white</i>	<i>matte white</i>	<i>ivory white</i>	<i>elox silver</i>	<i>anthracite</i>	<i>soft touch black</i>

**xham**  
*glass*



GL e bardhë  
*glass light*

**metal**  
*metal*



MH çelik i farkëtuar  
*hammered steel*

**dru**  
*wood*



WM panjë  
*maple*

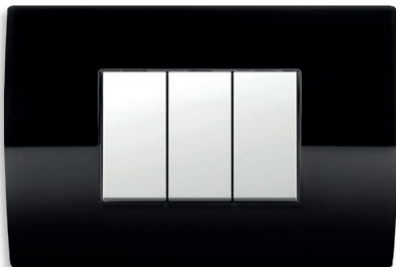

GD e zezë  
*glass dark*

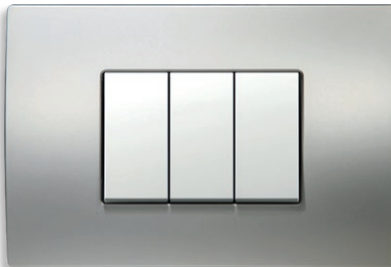

MS argjend satin  
*satin silver*



WB bambu  
*bamboo*



MN nikel satin  
*satin nickel*



WW arrë  
*walnut*



ME hekur i gdhendur  
*etched iron*



WE wenge  
*wenge*



MODUL

PURE



XHAM - i lehtë dhe i sofistikuar.  
Lëreni freskinë të fryjë si fllad nëpër të gjithë shtëpinë  
tuaj.

*GLASS - light and sophisticated.  
Let freshness breeze through your home.*





xham  
glass

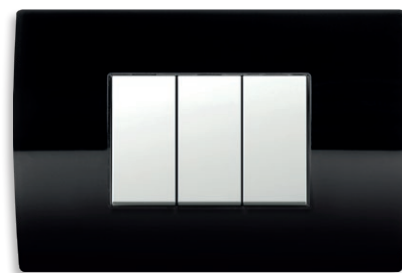



MODUL

PURE



METAL - i ftohtë, por fisnik.  
Përvetësojeni këtë material të dëlirë dhe  
tërhiqni vëmendjen e të tjerëve lehtësisht.

*METAL - cold, yet noble.  
Embrace this pristine material and  
effortlessly catch attention.*





metal  
*metal*

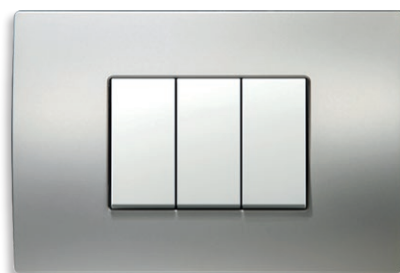



MODUL

PURE



DRURI - i gjithanshëm, por gjithsesi unik.  
Pranoni ngrohtësinë e natyrës.

*WOOD - versatile, yet unique.  
Give way to nature's warmth.*







**dru**  
*wood*

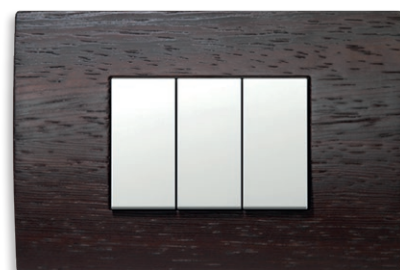

MODUL

EDGE

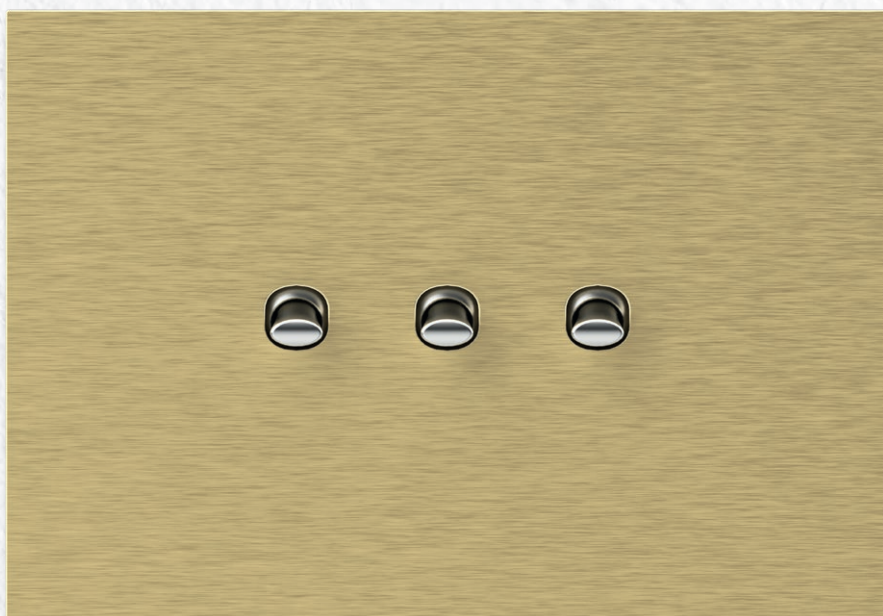

Linja e re prestigjioze e produkteve ofron një përvojë  
të veçantë ndijore dhe vizuale si asnjë tjetër më parë.  
A jeni aq të guximshëm?

*The new prestigious product line offers a special sensory and visual  
experience like no other before. Are you bold enough?*









MODUL

EDGE

PB



e zezë

*black*

PA



antracit

*anthracite*

PG



e artë

*gold*

PC



Krom

*chrome*

**metal**  
*metal*

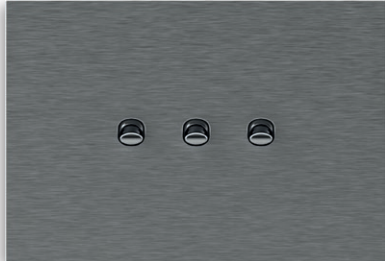

MA e argjendtë  
*silver*

**xham**  
*glass*



GL e bardhë  
*glass light*

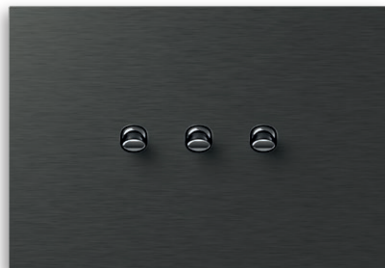

MT antracit  
*anthracite*



GD e zezë  
*glass dark*

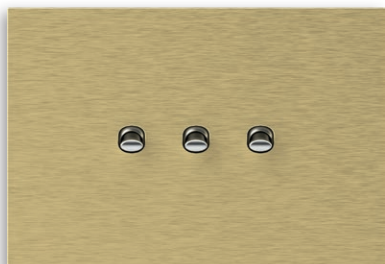

MZ e artë  
*gold*



MODUL  
EDGE



Pastërtia e xhamit lejon dritën që të manifestohet në mënyrë lozonjare në kapakët mbulues dekorativë të rinj EDGE. Dy ngjyra kontrasti kënaqin edhe shijet më të sofistikuara.

*The purity of the glass allows the light to playfully manifest in the new EDGE glass decorative cover plates. The two contrast colours satisfy even the most sophisticated taste.*





**xham**  
*glass*



GL e bardhë  
*glass light*



GD e zezë  
*glass dark*

MODUL  
EDGE



Falë trajtimit impresionues, alumini shkëlqen me një dritë të re – kapakët mbulues dekorativë metalikë EDGE. Tre ngjyrat vlejné të tërheqin vëmendjen tuaj.

*Thanks to the impressive treatment, the aluminium shines with a new light – EDGE metal decorative cover plates. The three colours are worthy of your attention.*







**metal**  
*metal*

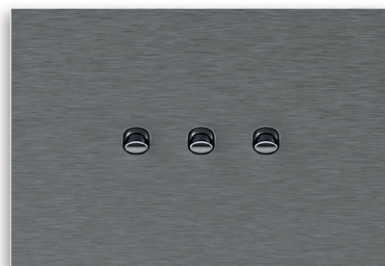

**MA** e argjendtë  
*silver*

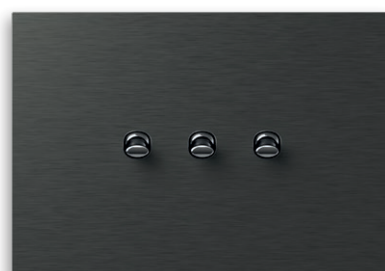

**MT** antracit  
*anthracite*

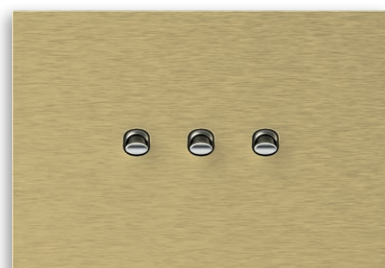

**MZ** e artë  
*gold*

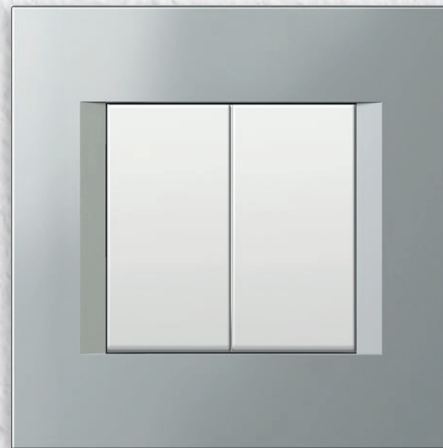

MODUL

-  LINE
-  SOFT
-  PURE
-  EDGE



+

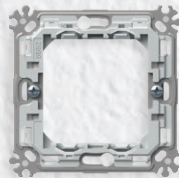

+



2M



2 x 2M



3 x 2M



4 x 2M



5 x 2M





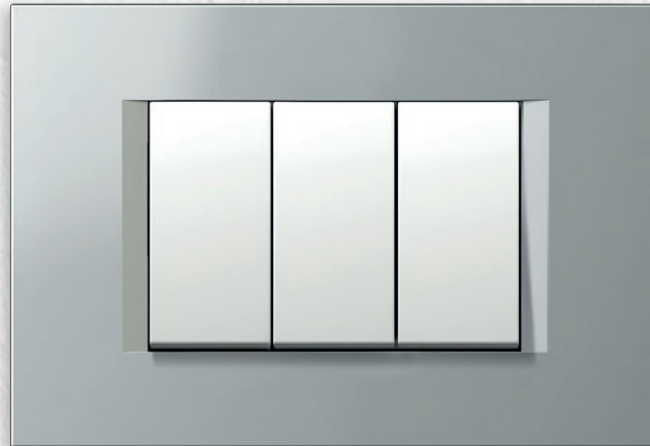
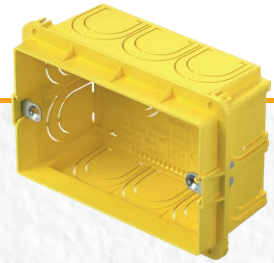

MODUL

- LINE
- SOFT
- PURE
- EDGE



2 x 7M

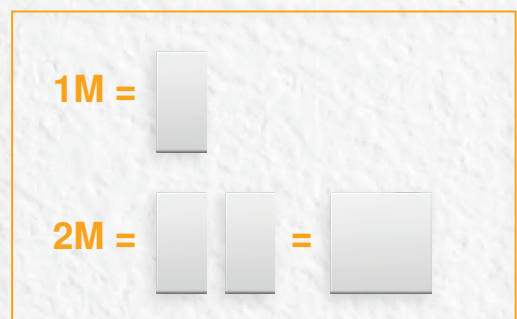



Elementet e funksionit futen lehtë brenda kornizës së montimit. Zgjidhja me “futje dhe nxjerrje në çast” që kemi zhvilluar për ju do t’ju reduktojë kohën e instalimit. Kontaktet e lidhjes arrihen lehtë nga pjesa e përparme.

The function elements are easily fitted inside the mounting frame.

The “klik-in, klik-out” solution we have developed for you will reduce installation time. The connection contacts are easily accessible from the front.

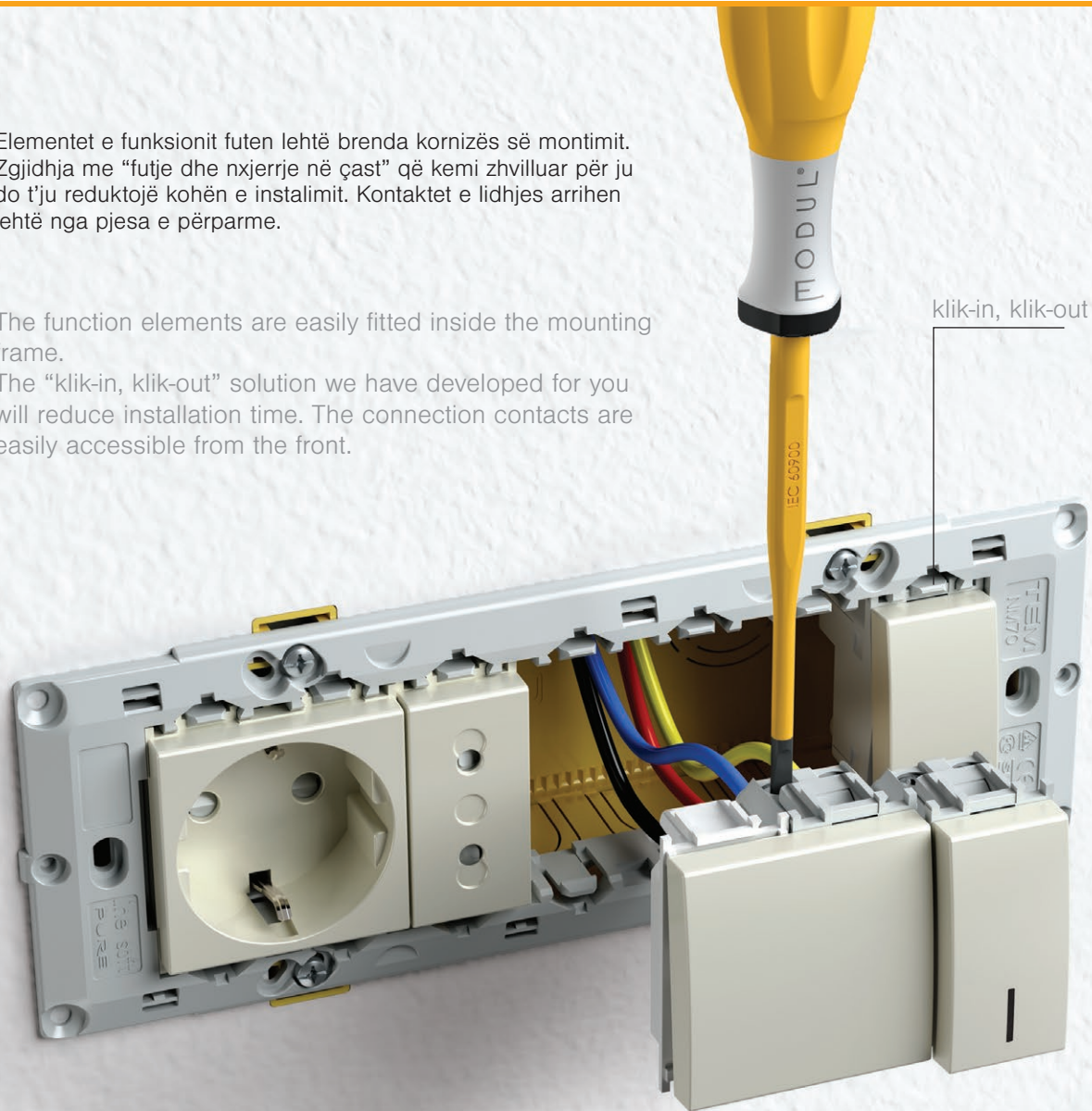



Modul është i përshtatshëm për të gjitha llojet e mureve dhe mund të përdoret në mure me konstruksione tradicionale, boshe ose betoni. Instalohet me lehtësi dhe ju jep mundësinë të kombinoni kutitë drejtkëndore ose të rrumbullakëta në distancat e duhura. Materialet e përdorura janë në pajtim me standardet më të larta.

The Modul is suitable for all wall types and can be used in conventional, hollow wall or concrete constructions. It is easy to install and enables you to combine rectangular or round boxes at the proper distances. The materials used are compliant with high standards.



tullë / brick



mur bosh / hollow wall



beton / concrete

Modul ofron mundësi të shumta edhe me kutitë drejtkëndore. Mund t'i kombinoni horizontalisht ose vertikalisht, individualisht ose në grupe. Korniza metalike e montimit siguron qëndrueshmëri të shkëlqyer edhe me përdorim të shpeshtë dhe është e përshtatshme për çdo kapak mbulues dekorativ.

The Modul enables a many possibilities even with round boxes. You can combine them horizontally or vertically, individually or in groups. The metal mounting frame ensures excellent stability even with rough use and is suitable for any decorative cover plates.

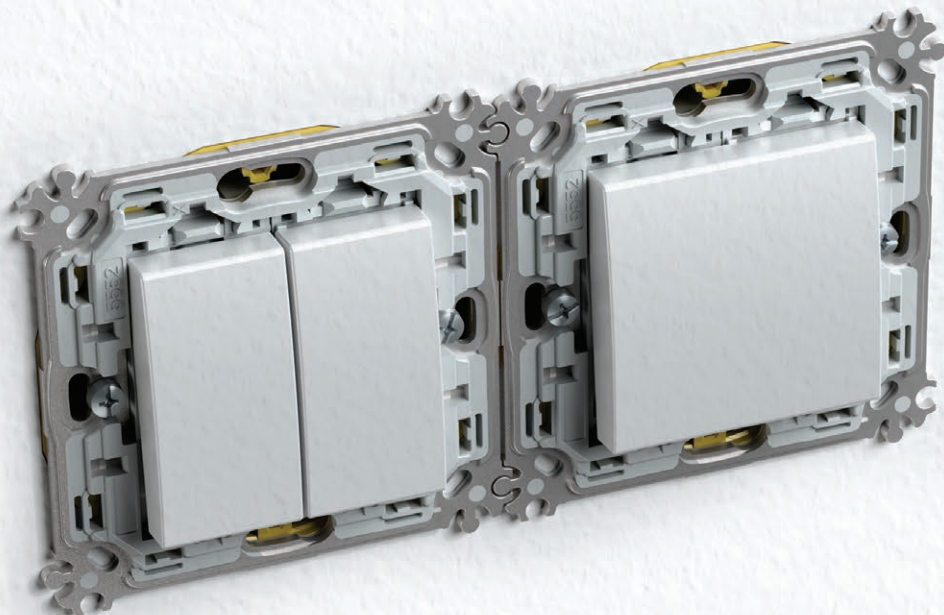





**PW**  
e bardhë polare  
*polar white*



**MW**  
e bardhë mat  
*matte white*



**SB**  
e zezë soft touch  
*soft touch black*



**AT**  
antracit  
*anthracite*



**ES**  
e argjendtë elox  
*elox silver*



**IW**  
e bardhë fildishi  
*ivory white*

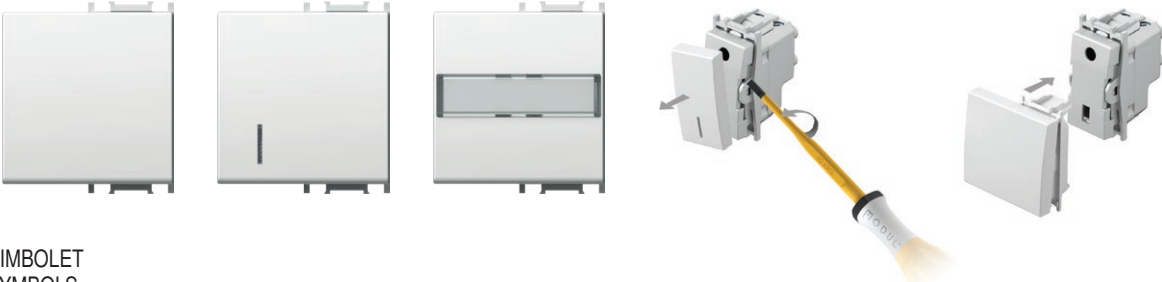

### SIMBOLET SYMBOLS

01	02	03	04	05	06	07	08	09	10	11	12	13	14	20	21
													1 0 2	+	-
22	23	24	25	26	27	28	29	30	31	32	33	34	35	36	37
					alarm	alarm	OFF	ON	+				AC		
38	39	40	41	42	43	44	45	46	47	48					

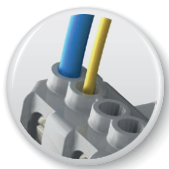
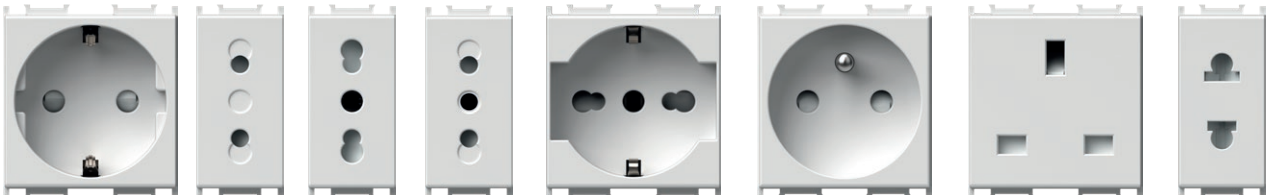

Lidhje e sigurt edhe kur përdoren madhësi të ndryshme telash.  
*Reliable connection even when different size of wires are used.*



Të gjitha prizat janë të pajisura me mbyllëse sigurie që garantojnë mbrojtjen e kontakteve nën tension.

*All the sockets are equipped with a safety shutters assuring the protection to live contacts.*

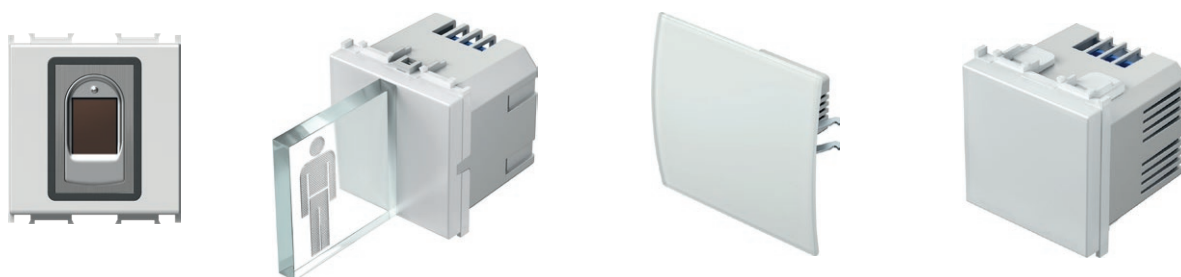
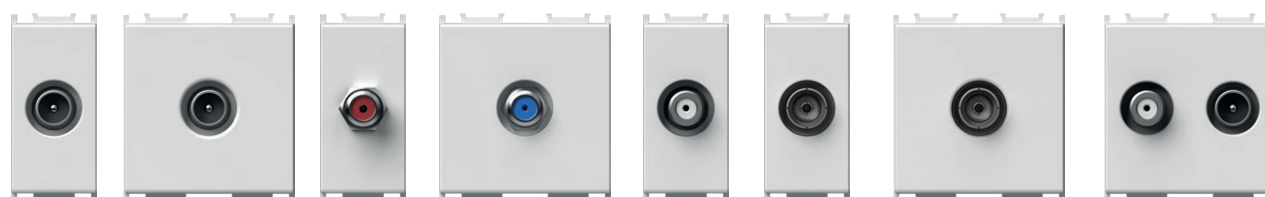
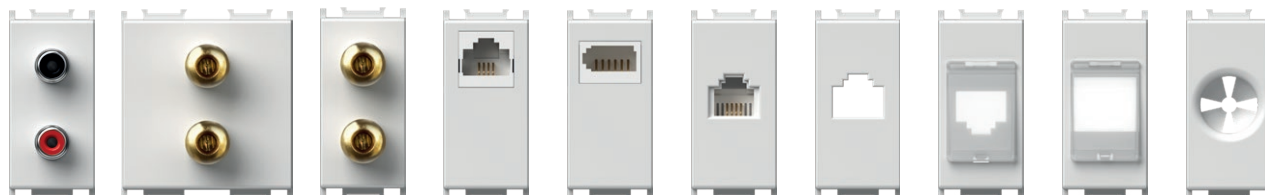

**IEC**  
**40.000**  
çelësat

Jetëgjatësi e çelësave dhe përputhje me standardet ndërkombëtare.

*Long-life of switches and adequacy to the international standards.*

**16 AX**  
kontaktet

Çelësi është shumë i sigurt përmes kontakteve të përçinave prej argjendi.

*The switch is highly reliable via its silver rivets contacts.*



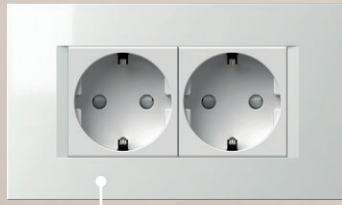
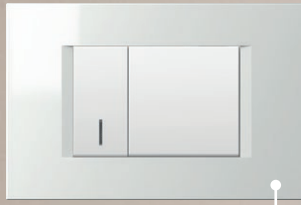







BIOPASS - çelës me gjurmë gishti

*BIOPASS - fingerprint switch*

Shkyçje pa çelës.

*Keyless unlocking.*

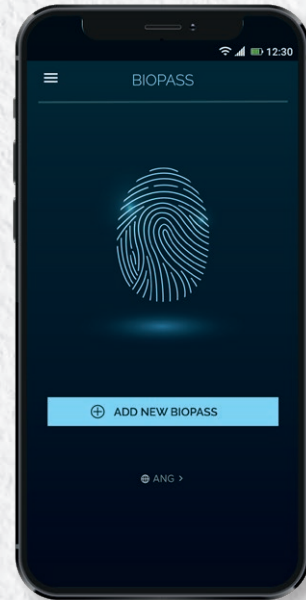

MULTIMEDIA

*MULTIMEDIA*

Qendër multimediale që do ju lejon të lidhni një numër të shumtë komponentësh në një vend.

*Multimedia center that allows you to connect a multiple number of components in one place.*





## BËJENI UNIKE

MAKE IT UNIQUE

Zgjidhni një ngjyrë ndriçimi dhe shtoni grafikën e dëshiruar që i përshtatet atmosferës së dhomës suaj.

*Choose a illumination colour and add desired graphic to suit the ambience of your room.*





KRIJONI TUAJIN  
CREATE YOUR OWN

Kur porositni sasi të mëdha, kapakët mbulues dhe elementet e funksionit mund të bëhen në ngjyrën e dëshiruar.

*When ordering large quantities, cover plates and function elements can be made in the colour of your choice.*









## KOHËMATËS ME SHUMË FUNKSIONE

MULTIPURPOSE TIMER SWITCH

4 in 1

- kohëmatës
- releja
- butoni me shtypje
- çelësi

4 in 1

- timer
- relay
- push button
- switch





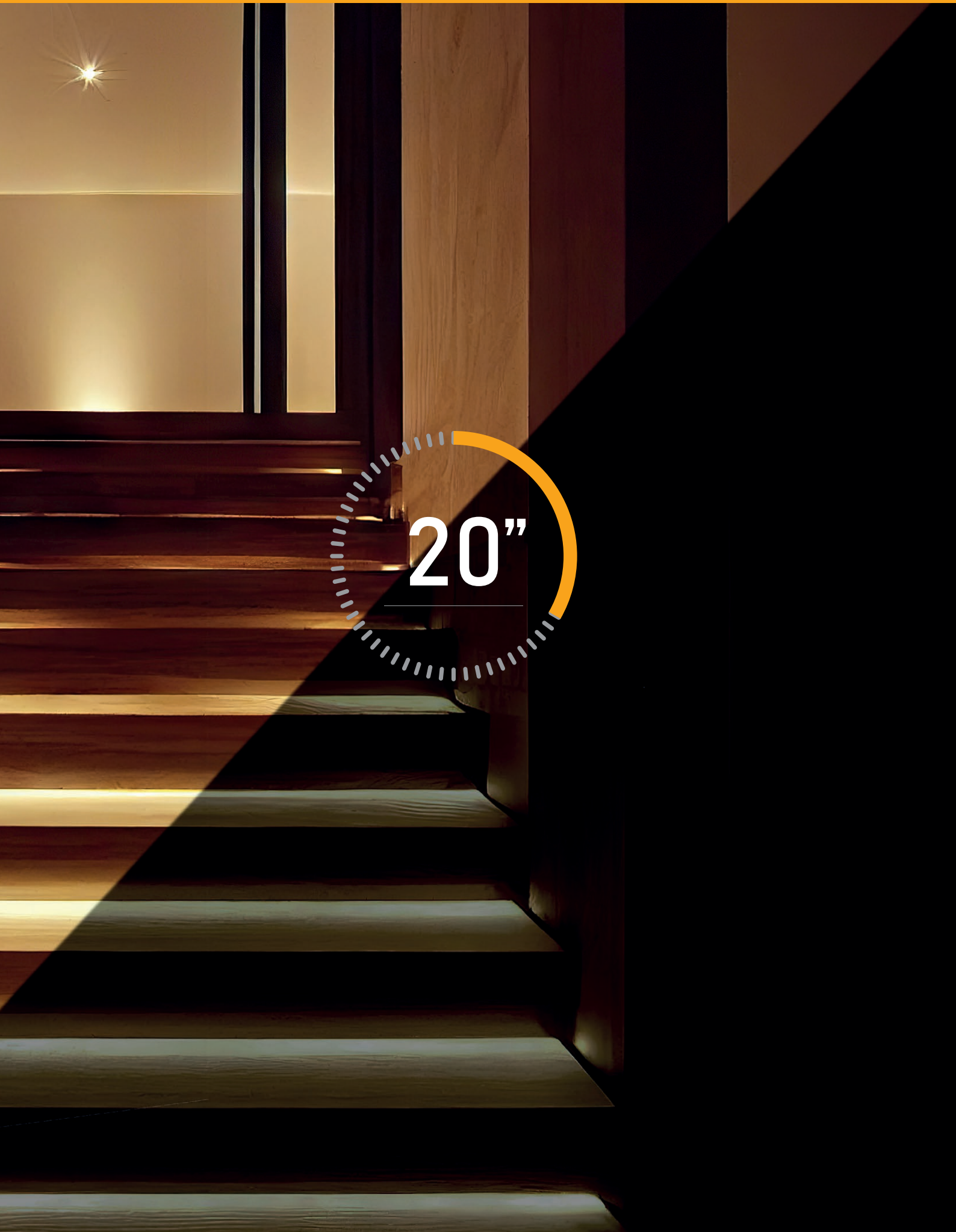

20"



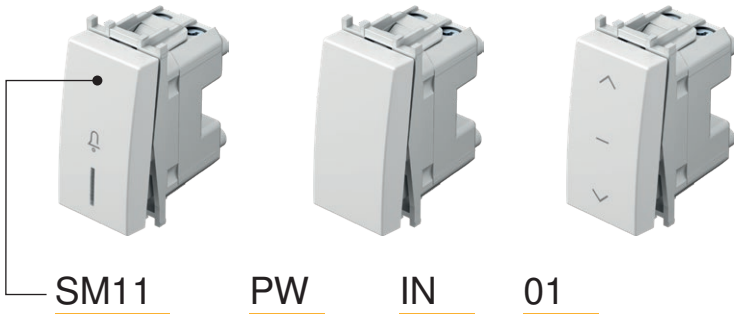

Iloji type	përshkrimi description	të dhënat teknike technical data	madhësia size	ngjyra colour	të dhënat opsionale 1 optional data 1	të dhënat opsionale 2 optional data 2
SM10	ÇELËS ME 1 DREJTIM SWITCH 1WAY	16AX 250V~	1M	<input type="checkbox"/> PW e bardhë polare polar white	<input type="checkbox"/> NT neutral neutral	01
SM11	BUTON MESHTYRJE ME 1 DREJTIM PUSH BUTTON 1WAY	16A 250V~	1M	<input type="checkbox"/> MW e bardhë mat matte white	<input type="checkbox"/> IN treguesi indicator	02
SM12	ÇELËS ME 1 DREJTIM SWITCH 1WAY	20A 250V~	1M	<input checked="" type="checkbox"/> SB e zezë soft touch soft touch black		03
⋮	⋮	⋮	⋮	<input type="checkbox"/> AT antracit anthracite		
⋮	⋮	⋮	⋮	<input type="checkbox"/> ES e argjendtë elox elox silver		
⋮	⋮	⋮	⋮	<input type="checkbox"/> IW e bardhë fildishi ivory white		

ÇELËS ME 1 DREJTIM 16 A X 250 V~ 1M



SM10



- çelës pa buton
- 16 A X 250 V~, Iloji SM10
- në përputhje me EN 60669-1
- kontaktet e vidave 1,5-2,5 mm<sup>2</sup>

SWITCH 1WAY 16AX 250V~ 1M  
- switch without replaceable button  
- 16AX 250V~, type SM10  
- in accordance with EN 60669-1  
- screw contacts 1.5-2.5mm<sup>2</sup>

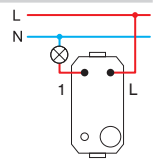

BUTON ME SHTYRJE ME 1 DREJTIM 16 A 250 V~ 1M



SM11



- buton me shtypje pa buton
- 16 A 250 V~, Iloji SM11
- në përputhje me EN 60669-1
- kontaktet e vidave 1,5-2,5 mm<sup>2</sup>

PUSH BUTTON 1WAY 16A 250V~ 1M  
- push button without replaceable button  
- 16A 250V~, type SM11  
- in accordance with EN 60669-1  
- screw contacts 1.5-2.5mm<sup>2</sup>

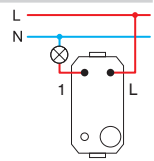

ÇELËS ME 1 DREJTIM 20 A 250 V~ 1M



SM12



- çelës pa buton
- 20 A 250 V~, Iloji SM12
- në përputhje me EN 60669-1
- kontaktet e vidave 1,5-2,5 mm<sup>2</sup>

SWITCH 1WAY 20A 250V~ 1M  
- switch without replaceable button  
- 20A 250V~, type SM12  
- in accordance with EN 60669-1  
- screw contacts 1.5-2.5mm<sup>2</sup>

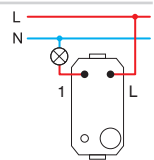

ÇELËS 2 POLAR 16 A X 250 V~ 1M



SM20

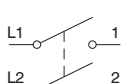

- çelës pa buton
- 16 A X 250 V~, Iloji SM20
- në përputhje me EN 60669-1
- kontaktet e vidave 1,5-2,5 mm<sup>2</sup>
- vetëm në kombinim me butonin TM15

SWITCH 2POLE 16AX 250V~ 1M  
- switch without replaceable button  
- 16AX 250V~, type SM20  
- in accordance with EN 60669-1  
- screw contacts 1.5-2.5mm<sup>2</sup>  
- only in combination with button TM15

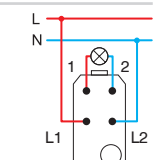

**MBYLLËSE ÇELËSI 1-0-2 16 A X 250 V~ 1M**



SM40



- çelës pa buton
  - 16 A X 250 V~, lloji SM40
  - në përputhje me EN 60669-1
  - kontaktet e vidave 1,5-2,5 mm<sup>2</sup>
- SWITCH SHUTTERS 1-0-2 16AX 250V~ 1M**
- switch without replaceable button
  - 16AX 250V~, type SM40
  - in accordance with EN 60669-1
  - screw contacts 1.5-2.5mm<sup>2</sup>

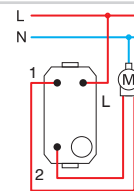

**MBYLLËSE ÇELËSI 1-0-2 16 A X 250 V~ 1M**



SM41

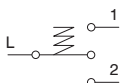

- buton me shtypje pa buton
  - 16 A 250 V~, lloji SM41
  - në përputhje me EN 60669-1
  - kontaktet e vidave 1,5-2,5 mm<sup>2</sup>
- PUSH BUTTON SHUTTERS 1-0-2 16A 250V~ 1M**
- push button without replaceable button
  - 16A 250V~, type SM41
  - in accordance with EN 60669-1
  - screw contacts 1.5-2.5mm<sup>2</sup>

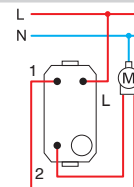

**ÇELËS ME 2 DREJTIME 16 A X 250 V~ 1M**



SM60

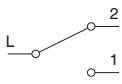

- çelës pa buton
  - 16 A X 250 V~, lloji SM60
  - në përputhje me EN 60669-1
  - kontaktet e vidave 1,5-2,5 mm<sup>2</sup>
- SWITCH 2WAY 16AX 250V~ 1M**
- switch without replaceable button
  - 16AX 250V~, type SM60
  - in accordance with EN 60669-1
  - screw contacts 1.5-2.5mm<sup>2</sup>

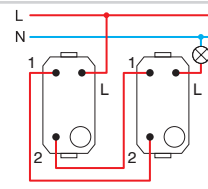

**BUTON ME SHTYPJË ME 2 DREJTIME 16 A 250 V~ 1M**



SM61

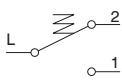

- buton me shtypje pa buton
  - 16 A 250 V~, lloji SM61
  - në përputhje me EN 60669-1
  - kontaktet e vidave 1,5-2,5 mm<sup>2</sup>
- PUSH BUTTON 2WAY 16A 250V~ 1M**
- push button without replaceable button
  - 16A 250V~, type SM61
  - in accordance with EN 60669-1
  - screw contacts 1.5-2.5mm<sup>2</sup>

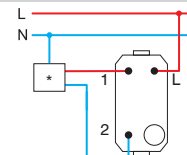

\* lidhjet elektronike / electronics

**ÇELËS NDËRMJETËS 16 A X 250 V~ 1M**



SM70

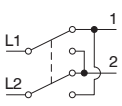

- çelës pa buton
  - 16 A X 250 V~, lloji SM70
  - në përputhje me EN 60669-1
  - kontaktet e vidave 1,5-2,5 mm<sup>2</sup>
- SWITCH INTERMEDIATE 16AX 250V~ 1M**
- switch without replaceable button
  - 16AX 250V~, type SM70
  - in accordance with EN 60669-1
  - screw contacts 1.5-2.5mm<sup>2</sup>

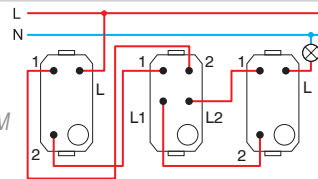

1M = 22,5 x 45  
2M = 45 x 45

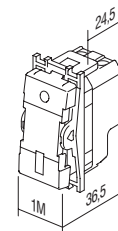
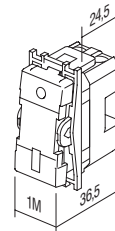





□ PW e bardhë polare  
polar white  
□ MW e bardhë mat  
matte white



■ SB e zezë soft touch  
soft touch black



■ AT antracit  
anthracite



□ ES e argjendtë elox  
elox silver



□ IW e bardhë fildishi  
ivory white

ÇELËS ME 1 DREJTIM 16 A X 250 V~ 1M



- SM10PW
- SM10MW
- SM10SB
- SM10AT
- SM10ES
- SM10IW

- 16 A X 250 V~, Iloji SM10  
- në përputhje me EN 60669-1  
- kontaktet e vidave 1,5-2,5 mm<sup>2</sup>  
- buton i ndërrueshëm

*SWITCH 1WAY 16AX 250V~ 1M*  
- 16AX 250V~, type SM10  
- in accordance with EN 60669-1  
- screw contacts 1.5-2.5 mm<sup>2</sup>  
- replaceable button



ÇELËS ME 1 DREJTIM 16 A X 250 V~ 1M \_\_ IN



- SM10PWIN
- SM10MWIN
- SM10SBIN
- SM10ATIN
- SM10ESIN
- SM10IWIN

- IN tregues  
- 16 A X 250 V~, Iloji SM10  
- në përputhje me EN 60669-1  
- kontaktet e vidave 1,5-2,5 mm<sup>2</sup>  
- llamba nuk është e përfshirë  
- buton i ndërrueshëm

*SWITCH 1WAY 16AX 250V~ 1M \_\_ IN*  
- IN indicator  
- 16AX 250V~, type SM10  
- in accordance with EN 60669-1  
- screw contacts 1.5-2.5 mm<sup>2</sup>  
- lamp is not included  
- replaceable button



BUTON ME SHTYPJE ME 1 DREJTIM 16 A 250 V~ 1M

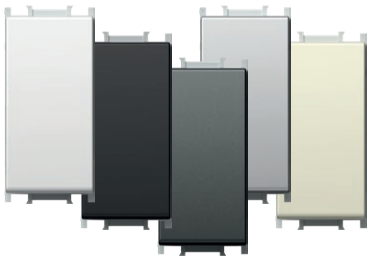

- SM11PW
- SM11MW
- SM11SB
- SM11AT
- SM11ES
- SM11IW

- 16 A 250 V~, Iloji SM11  
- në përputhje me EN 60669-1  
- kontaktet e vidave 1,5-2,5 mm<sup>2</sup>  
- buton i ndërrueshëm

*PUSH BUTTON 1WAY 16A 250V~ 1M*  
- 16A 250V~, type SM11  
- in accordance with EN 60669-1  
- screw contacts 1.5-2.5 mm<sup>2</sup>  
- replaceable button



BUTON ME SHTYPJE ME 1 DREJTIM 16 A 250 V~ 1M \_\_ IN 01



- SM11PWIN01
- SM11MWIN01
- SM11SBIN01
- SM11ATIN01
- SM11ESIN01
- SM11IWIN01

- IN 01 zile treguese  
- 16 A 250 V~, Iloji SM11  
- në përputhje me EN 60669-1  
- kontaktet e vidave 1,5-2,5 mm<sup>2</sup>  
- llamba nuk është e përfshirë  
- buton i ndërrueshëm

*PUSH BUTTON 1WAY 16A 250V~ 1M \_\_ IN 01*  
- IN 01 indicator bell  
- 16A 250V~, type SM11  
- in accordance with EN 60669-1  
- screw contacts 1.5-2.5 mm<sup>2</sup>  
- lamp is not included  
- replaceable button



## S W I T C H E S S M

## BUTON ME SHYTPJE ME 1 DREJTIM 16 A 250 V~ 1M \_\_ IN 02



- SM11PWIN02
- SM11MWIN02
- SM11SBIN02
- SM11ATIN02
- SM11ESIN02
- SM11IWIN02

- IN 02 dritë treguese  
- 16 A 250 V~, lloji SM11  
- në përputhje me EN 60669-1  
- kontaktet e vidave 1,5-2,5 mm<sup>2</sup>  
- llamba nuk është e përfshirë  
- buton i ndërrueshëm

*PUSH BUTTON 1WAY 16A 250V~ 1M \_\_ IN 02*

- IN 02 indicator light  
- 16A 250V~, type SM11  
- in accordance with EN 60669-1  
- screw contacts 1.5-2.5 mm<sup>2</sup>  
- lamp is not included  
- replaceable button



## ÇELËS 2 POLAR 16 A X 250 V~ 1M \_\_ NT 03

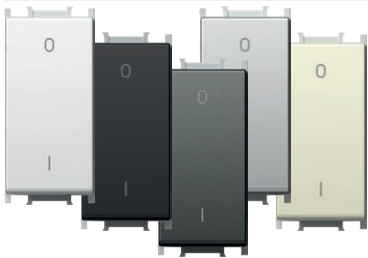

- SM20PWNT03
- SM20MWNT03
- SM20SBNT03
- SM20ATNT03
- SM20ESNT03
- SM20IWNT03

- NT 03 neutral 0-1  
- 16 A X 250 V~, lloji SM20  
- në përputhje me EN 60669-1  
- kontaktet e vidave 1,5-2,5 mm<sup>2</sup>  
- buton i ndërrueshëm

*SWITCH 2POLE 16AX 250V~ 1M \_\_ NT 03*

- NT 03 neutral 0-1  
- 16AX 250V~, type SM20  
- in accordance with EN 60669-1  
- screw contacts 1.5-2.5 mm<sup>2</sup>  
- replaceable button



## ÇELËS 2 POLAR 16 A X 250 V~ 1M \_\_ IN



- SM20PWIN
- SM20MWIN
- SM20SBIN
- SM20ATIN
- SM20ESIN
- SM20IWIN

- IN tregues  
- 16 A X 250 V~, lloji SM20  
- në përputhje me EN 60669-1  
- kontaktet e vidave 1,5-2,5 mm<sup>2</sup>  
- llamba nuk është e përfshirë  
- buton i ndërrueshëm

*SWITCH 2POLE 16AX 250V~ 1M \_\_ IN*

- IN indicator  
- 16AX 250V~, type SM20  
- in accordance with EN 60669-1  
- screw contacts 1.5-2.5 mm<sup>2</sup>  
- lamp is not included  
- replaceable button



## MBYLLËSE ÇELËSI 1-0-2 16 A X 250 V~ 1M \_\_ NT 10

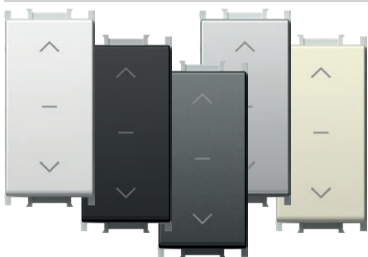

- SM40PWNT10
- SM40MWNT10
- SM40SBNT10
- SM40ATNT10
- SM40ESNT10
- SM40IWNT10

- NT 10 neutral 1-0-2  
- 16 A X 250 V~, lloji SM40  
- në përputhje me EN 60669-1  
- kontaktet e vidave 1,5-2,5 mm<sup>2</sup>  
- buton i ndërrueshëm

*SWITCH SHUTTERS 1-0-2 16AX 250V~ 1M \_\_ NT 10*

- NT 10 neutral 1-0-2  
- 16AX 250V~, type SM40  
- in accordance with EN 60669-1  
- screw contacts 1.5-2.5mm<sup>2</sup>  
- replaceable button



## MBYLLËSE BUTONI ME SHYTPJE 1-0-2 16 A 250 V~ 1M \_\_ NT 10

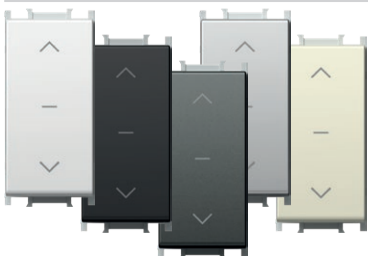

- SM41PWNT10
- SM41MWNT10
- SM41SBNT10
- SM41ATNT10
- SM41ESNT10
- SM41IWNT10

- NT 10 neutral 1-0-2  
- 16 A 250 V~, lloji SM41  
- në përputhje me EN 60669-1  
- kontaktet e vidave 1,5-2,5 mm<sup>2</sup>  
- buton i ndërrueshëm

*PUSH BUTTON SHUTTERS 1-0-2 16A 250V~ 1M \_\_ NT 10*

- NT 10 neutral 1-0-2  
- 16A 250V~, type SM41  
- in accordance with EN 60669-1  
- screw contacts 1.5-2.5mm<sup>2</sup>  
- replaceable button



## ÇELËS ME 2 DREJTIME 16 A X 250 V~ 1M



- SM60PW
- SM60MW
- SM60SB
- SM60AT
- SM60ES
- SM60IW

- 16 A X 250 V~, lloji SM60  
- në përputhje me EN 60669-1  
- kontaktet e vidave 1,5-2,5 mm<sup>2</sup>  
- buton i ndërrueshëm

*SWITCH 2WAY 16AX 250V~ 1M*

- 16AX 250V~, type SM60  
- in accordance with EN 60669-1  
- screw contacts 1.5-2.5 mm<sup>2</sup>  
- replaceable button





BUTON ME SHYTPJE ME 2 DREJTIME 16 A 250 V~ 1M

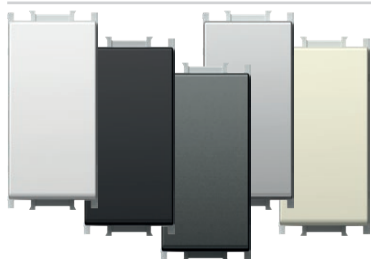

- SM61PW
- SM61MW
- SM61SB
- SM61AT
- SM61ES
- SM61IW

- 16 A 250 V~, Iloji SM61  
 - në përputhje me EN 60669-1  
 - kontaktet e vidave 1,5-2,5 mm<sup>2</sup>  
 - buton i ndërrueshëm

*PUSH BUTTON 2WAY 16A 250V~ 1M*

- 16A 250V~, type SM61  
 - in accordance with EN 60669-1  
 - screw contacts 1.5-2.5 mm<sup>2</sup>  
 - replaceable button



BUTON ME SHYTPJE ME 2 DREJTIME ME KORDON 16 A 250 V~ 1M \_\_ CD



- SM62PWCD
- SM62MWCD
- SM62SB
- SM62AT
- SM62ESCD
- SM62IWCD

- CD treguesi+kordoni  
 - gjatësia e kordonit 1.5 m  
 - 16 A 250 V~, Iloji SM62  
 - në përputhje me EN 60669-1  
 - kontaktet e vidave 1,5-2,5 mm<sup>2</sup>

*PUSH BUTTON 2WAY WITH CORD 16A 250V~ 1M \_\_ CD*

- CD indicator+cord  
 - cord lenght 1.5m  
 - 16A 250V~, type SM62  
 - in accordance with EN 60669-1  
 - screw contacts 1.5-2.5 mm<sup>2</sup>



ÇELËS NDËRMJETËS 16 A X 250 V~ 1M



- SM70PW
- SM70MW
- SM70SB
- SM70AT
- SM70ES
- SM70IW

- 16 A X 250 V~, Iloji SM70  
 - në përputhje me EN 60669-1  
 - kontaktet e vidave 1,5-2,5 mm<sup>2</sup>  
 - buton i ndërrueshëm

*SWITCH INTERMEDIATE 16AX 250V~ 1M*

- 16AX 250V~, type SM70  
 - in accordance with EN 60669-1  
 - screw contacts 1.5-2.5 mm<sup>2</sup>  
 - replaceable button



1M = 22,5 x 45  
 2M = 45 x 45

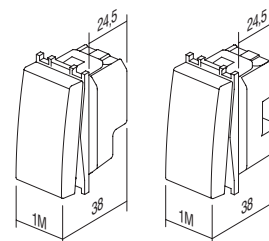

## B U T T O N S T M

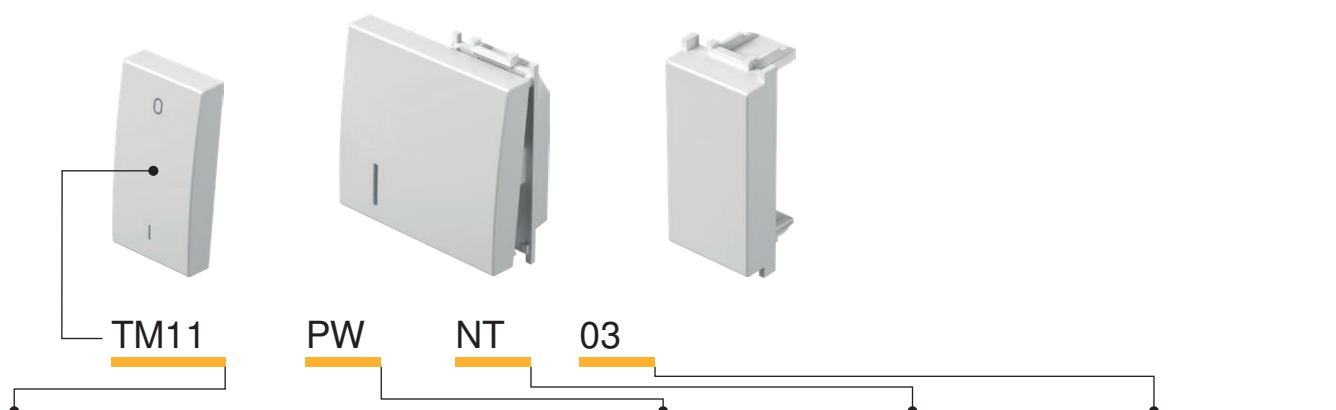

Iloji type	përshkrimi description	madhësia size	ngjyra colour	të dhënat opsionale 1 optional data 1	të dhënat opsionale 2 optional data 2
TM11	BUTON BUTTON	1M	<input type="checkbox"/> PW e bardhë polare polar white	<input type="checkbox"/> NT neutral neutral	01
TM12	BUTON BUTTON	2M	<input type="checkbox"/> MW e bardhë mat matte white	<input type="checkbox"/> IN treguesi indicator	02
TM21	FALSO BLANK	1M	<input checked="" type="checkbox"/> SB e zezë soft touch soft touch black		03
:	:	:	<input type="checkbox"/> AT antracit anthracite		
:	:	:	<input type="checkbox"/> ES e argjendtë elox elox silver		
:	:	:	<input type="checkbox"/> IW e bardhë fildishi ivory white		

## BUTON 1M



- TM11PW
- TM11MW
- TM11SB
- TM11AT
- TM11ES
- TM11IW

- buton i ndërrueshëm 1M  
- në përputhje me EN 60669-1  
**BUTTON 1M**  
- replaceable button 1M  
- in accordance with EN 60669-1



## TREGUES BUTONI 1M



- TM11PWIN
- TM11MWIN
- TM11SBIN
- TM11ATIN
- TM11ESIN
- TM11IWIN

- buton i ndërrueshëm 1M  
- në përputhje me EN 60669-1  
**BUTTON 1M INDICATOR**  
- replaceable button 1M  
- in accordance with EN 60669-1



## BUTON 2M

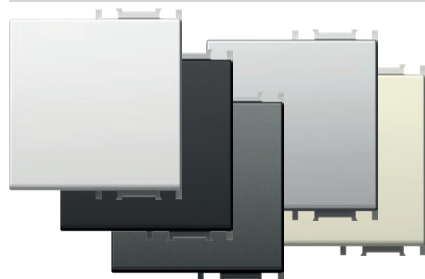

- TM12PW
- TM12MW
- TM12SB
- TM12AT
- TM12ES
- TM12IW

- buton i ndërrueshëm 2M me mbajtëse butoni  
- për të përditësuar çelësin ose butonin me shtypje nga madhësia 1M në madhësinë 2M  
- në përputhje me EN 60669-1  
**BUTTON 2M**  
- replaceable button 2M with button carrier  
- to upgrade switch or push button from size 1M to size 2M  
- in accordance with EN 60669-1



## TREGUES BUTONI 2M

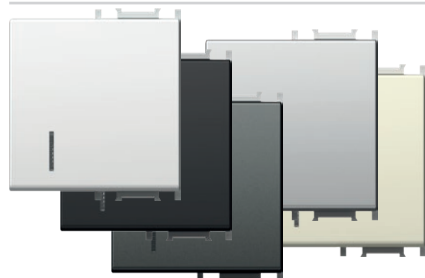

- TM12PWIN
- TM12MWIN
- TM12SBIN
- TM12ATIN
- TM12ESIN
- TM12IWIN

- buton i ndërrueshëm 2M me mbajtëse butoni  
- për të përditësuar çelësin ose butonin me shtypje nga madhësia 1M në madhësinë 2M  
- në përputhje me EN 60669-1  
**BUTTON 2M INDICATOR**  
- replaceable button 2M with button carrier  
- to upgrade switch or push button from size 1M to size 2M  
- in accordance with EN 60669-1





BUTON 2M ME KAPAK ME MBISHKRIM

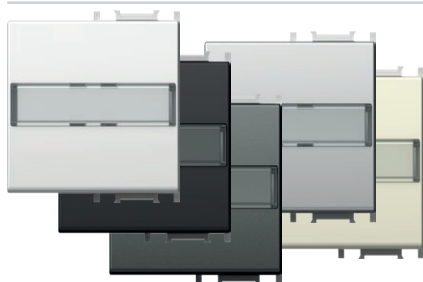

- TM13PWIL
- TM13MWIL
- TM13SBIL
- TM13ATIL
- TM13ESIL
- TM13IWIL

- buton i ndërrueshëm 2M me mbajtëse butoni  
 - për të përditësuar çelësin ose butonin me shtypje nga madhësia 1M në madhësinë 2M  
 - në përputhje me EN 60669-1

*BUTTON 2M WITH INSCRIPTION PLATE*  
 - replaceable button 2M with button carrier  
 - to upgrade switch or push button from size 1M to size 2M  
 - in accordance with EN 60669-1



BUTON 1M 2 POLAR

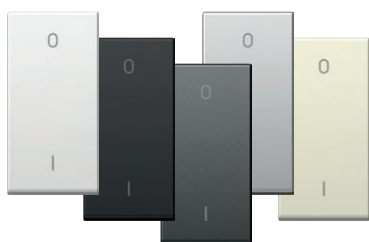

- TM15PW
- TM15MW
- TM15SB
- TM15AT
- TM15ES
- TM15IW

- buton i ndërrueshëm 1M  
 - vetëm në kombinim me mekanizmin SM20  
 - në përputhje me EN 60669-1

*BUTTON 1M 2POLE*  
 - replaceable button 1M  
 - only in combination with mechanism SM20  
 - in accordance with EN 60669-1



FALSO 1M

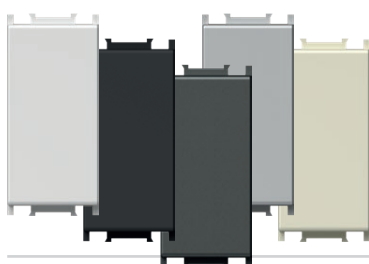

- TM21PW
- TM21MW
- TM21SB
- TM21AT
- TM21ES
- TM21IW

- modul falso për të mbushur hapësirat boshe  
 - në përputhje me EN 60669-1

*BLANK 1M*  
 - blank modul to fill up empty spaces  
 - in accordance with EN 60669-1



FALSO 2M

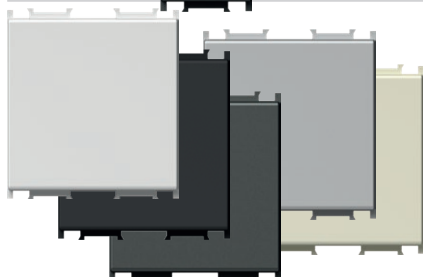

- TM22PW
- TM22MW
- TM22SB
- TM22AT
- TM22ES
- TM22IW

- modul falso për të mbushur hapësirat boshe  
 - në përputhje me EN 60669-1

*BLANK 2M*  
 - blank modul to fill up empty spaces  
 - in accordance with EN 60669-1

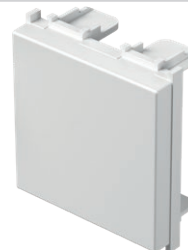

DALJE PËR KABLO 1M

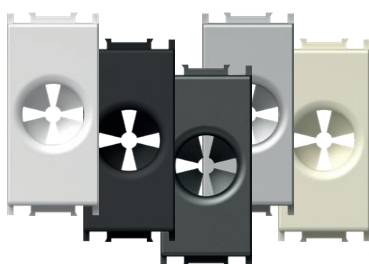

- TM31PW
- TM31MW
- TM31SB
- TM31AT
- TM31ES
- TM31IW

- dalje për kablo  
 - në përputhje me EN-60669-1

*CABLE OUTLET 1M*  
 - outlet for cable  
 - in accordance with EN-60669-1



1M = 22,5 x 45  
 2M = 45 x 45

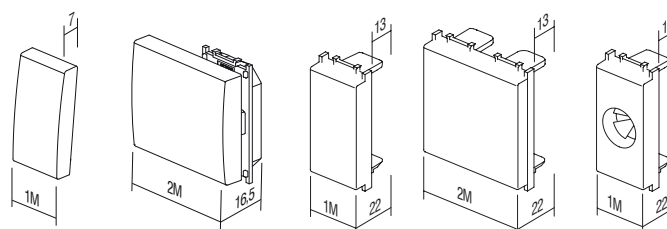

TM11  
 TM15

TM12  
 TM13

TM21

TM22

TM31

## B U T T O N S T M

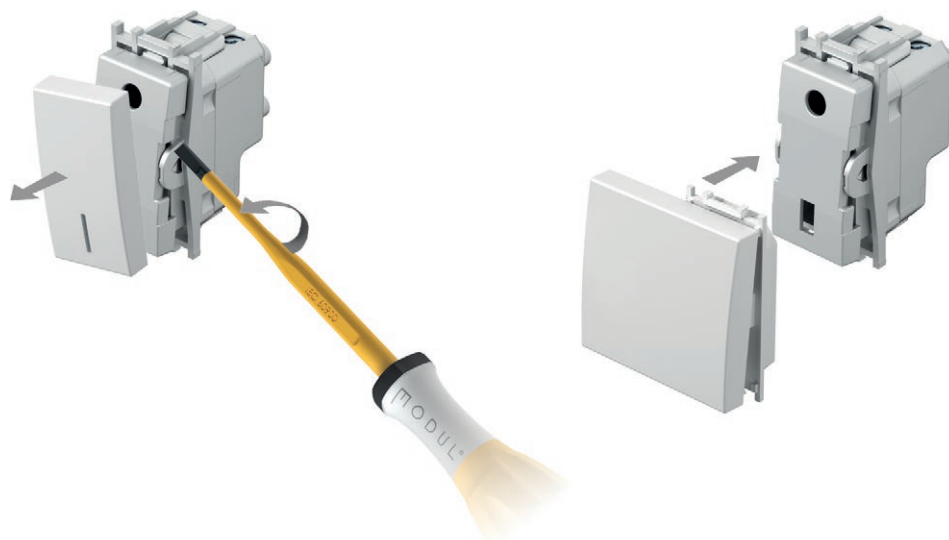

## PRINTIM ME LAZER MBI BUTONA

- printim me lazer i çdo lloj grafike në vendet e shënuara
- simbole standarde nga stoku, të tjerat sipas kërkesës

## LASER PRINT ON BUTTONS

- laser print of any graphics on marked locations
- standard symbols from stock, other on request

1M

A
B
C

2M

A	D	G
B	E	H
C	F	I

## SIMBOLET

## SYMBOLS

01	02	03	04	05	06	07	08	09	10	11	12	13	14	20	21
													1 0 2	+	-
22	23	24	25	26	27	28	29	30	31	32	33	34	35	36	37
					alarm	alarm	OFF	ON	+				AC		
38	39	40	41	42	43	44	45	46	47	48					

## SIMBOLET STANDARDE

## STANDARD SYMBOLS

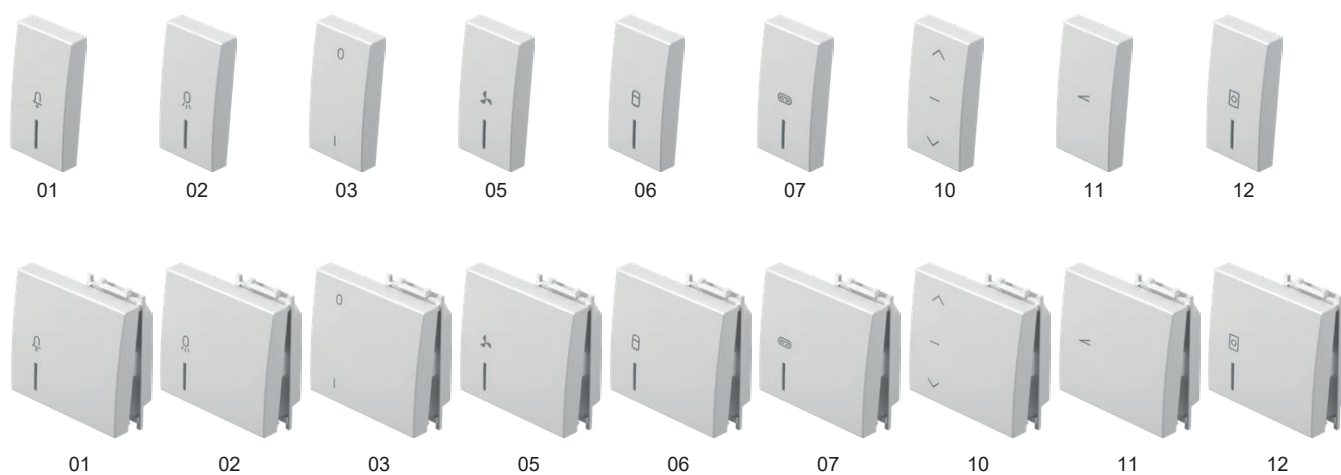



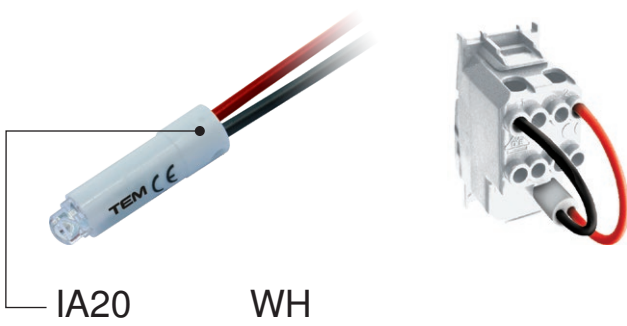

Iloji type	përshkrimi description	të dhënat teknike technical data	ngjyra colour
IA10	LLAMBË NEONI NEON LAMP	230V~ 0,34W	<input type="checkbox"/> WH e bardhë white
IA20	SINJALIZIMI LED LED SIGNALLING UNIT	230V~ AC/DC 0,40W	<input checked="" type="checkbox"/> BL blu blue
IA21	SINJALIZIMI LED LED SIGNALLING UNIT	24V AC/DC 0,20W	<input checked="" type="checkbox"/> RD e kuqe red
·	·	·	<input checked="" type="checkbox"/> GR e gjelbër green
·	·	·	<input checked="" type="checkbox"/> OR portokalli orange

LLAMBË NEONI 230 V~ 0,34 W

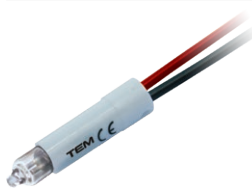

IA10OR

- për indikim, sinjalizim ose sinjalizim të përhershëm
  - në kombinim me një buton që ka një tregues
- NEON LAMP 230V~ 0,34W
- for indication, signalling or permanent signalling
  - in combination with a button featuring an indicator

SINJALIZIMI LED 230 V AC/DC 0,40 W

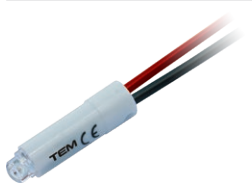

- IA20WH
- IA20GR
- IA20RD
- IA20BL

- për indikim, sinjalizim ose sinjalizim të përhershëm
  - në kombinim me një buton që ka një tregues
- LED SIGNALLING UNIT 230V AC/DC 0,40W
- for indication, signalling or permanent signalling
  - in combination with a button featuring an indicator

SINJALIZIMI LED 24V AC/DC 0,20W



- IA21WH
- IA21RD

- për indikim, sinjalizim ose sinjalizim të përhershëm
  - në kombinim me një buton që ka një tregues
- LED SIGNALLING UNIT LAMP 24V AC/DC 0,20W
- for indication, signalling or permanent signalling
  - in combination with a button featuring an indicator

SINJALIZIMI LED 12V AC/DC 0,10W



- IA22WH
- IA22RD

- për indikim, sinjalizim ose sinjalizim të përhershëm
  - në kombinim me një buton që ka një tregues
- LED SIGNALLING UNIT 12V AC/DC 0,10W
- for indication, signalling or permanent signalling
  - in combination with a button featuring an indicator

QARK RC 250 V~



IA50

- qark RC për të eliminuar ndërhyrjet në funksionim të llambave LED
  - lidhje paralele me më shumë qarqe RC dhe llamba janë të mundshme
  - 0,1 µF, 100 Ω, 250V~
- RC CIRCUIT 250V~
- RC circuit to eliminate disturbances in the operation of LED lamps
  - parallel connections of more RC circuits with lamps are possible
  - 0,1 µF, 100 Ω, 250V~

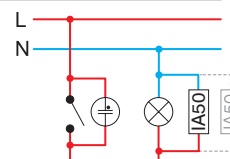

S I G N A L I Z A T I O N I A

Treguesi /  
Indication

\* Sinjalizimi /  
Signalization

Sinjalizimi i përhershëm /  
Permanent signalling

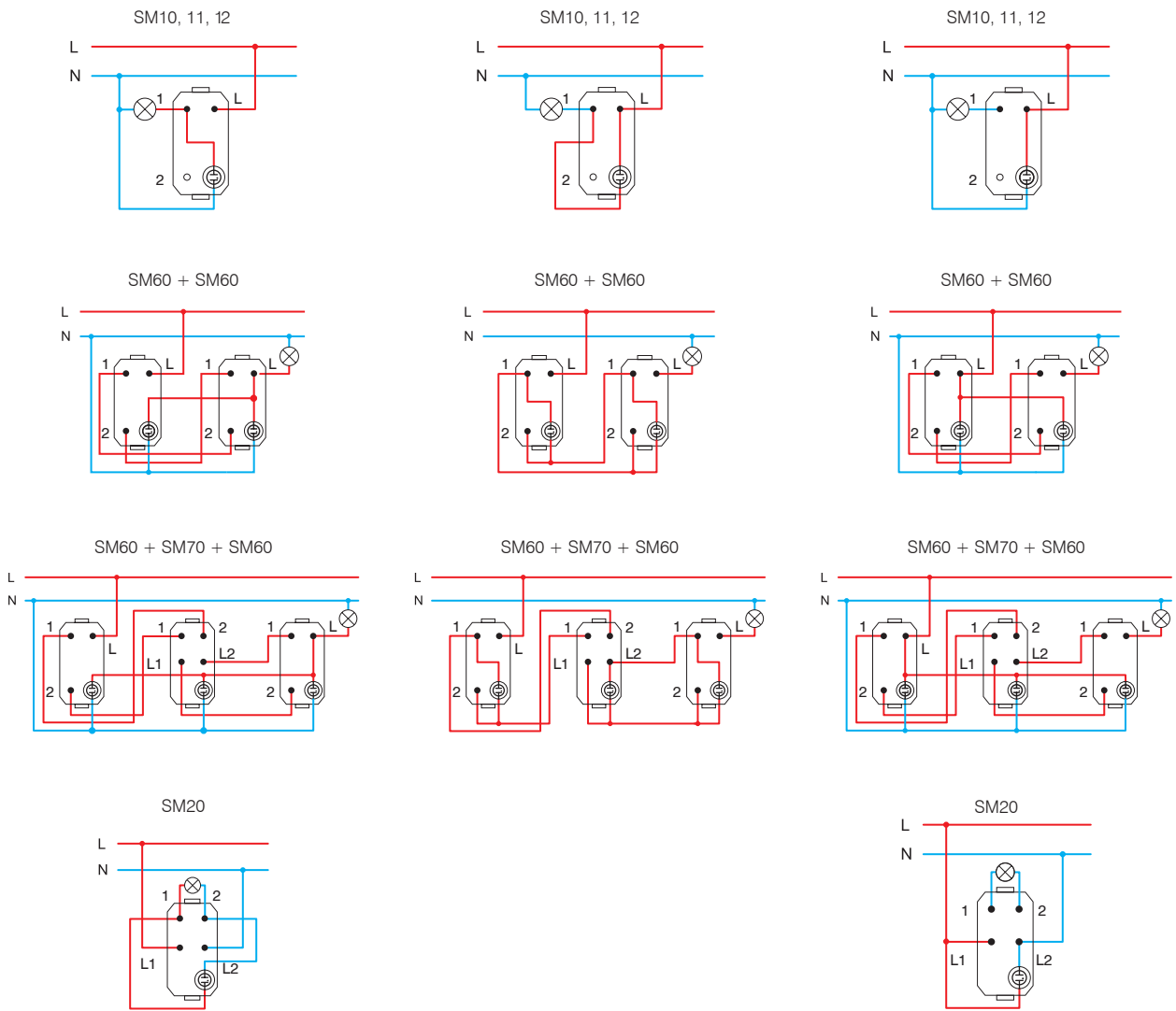

\* lidhjet nuk janë të përshtatshme për llambat që kursejnë energji (CFL, LED) /  
the connections are not suitable for energy-saving bulbs (CFL, LED)

1M = 22,5 x 45  
2M = 45 x 45

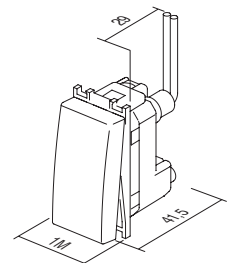



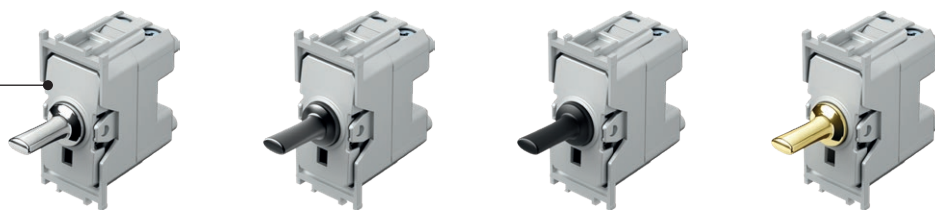

SP10

PC

Iloji type	përshkrimi description	të dhënat teknike technical data	madhësia size	ngjyra e kunjit pin colour
SP10	ÇELËS ME 1 DREJTIM SWITCH 1WAY	16AX 250V~	1M	■ PC krom chrome
SP11	BUTON ME SHTYPJE ME 1 DREJTIM PUSH BUTTON 1WAY	16A 250V~	1M	■ PA antracit anthracite
SP12	ÇELËS ME 1 DREJTIM SWITCH 1WAY	20A 250V~	1M	■ PB e zezë black
...	...	...	...	■ PG e artë gold

ÇELËS ME 1 DREJTIM 16 A X 250 V~ 1M



- SP10PC
- SP10PA
- SP10PB
- SP10PG

- çelësi  
- 16AX 250V~, Iloji SP10  
- në përputhje me EN 60669-1  
- kontaktet e vidave 1,5-2,5 mm<sup>2</sup>  
**SWITCH 1WAY 16AX 250V~ 1M**  
- switch  
- 16AX 250V~, type SP10  
- in accordance with EN 60669-1  
- screw contacts 1.5-2.5mm<sup>2</sup>

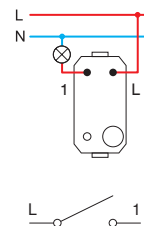

BUTON ME SHTYPJE ME 1 DREJTIM 16 A 250 V~ 1M



- SP11PC
- SP11PA
- SP11PB
- SP11PG

- butoni me shtypje  
- 16 A 250 V~, Iloji SP11  
- në përputhje me EN 60669-1  
- kontaktet e vidave 1,5-2,5 mm<sup>2</sup>  
**PUSH BUTTON 1WAY 16A 250V~ 1M**  
- push button  
- 16A 250V~, type SP11  
- in accordance with EN 60669-1  
- screw contacts 1.5-2.5mm<sup>2</sup>

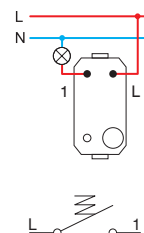

ÇELËS ME 1 DREJTIM 20 A X 250 V~ 1M



- SP12PC
- SP12PA
- SP12PB
- SP12PG

- çelësi  
- 20 A 250 V~, Iloji SP12  
- në përputhje me EN 60669-1  
- kontaktet e vidave 1,5-2,5 mm<sup>2</sup>  
**SWITCH 1WAY 20A 250V~ 1M**  
- switch  
- 20A 250V~, type SP12  
- in accordance with EN 60669-1  
- screw contacts 1.5-2.5mm<sup>2</sup>

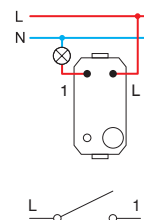

ÇELËS 2 POLAR 16 A X 250 V~ 1M



- SP20PC
- SP20PA
- SP20PB
- SP20PG

- çelësi  
- 16 A X 250 V~, Iloji SP20  
- në përputhje me EN 60669-1  
- kontaktet e vidave 1,5-2,5 mm<sup>2</sup>  
**SWITCH 2POLE 16AX 250V~ 1M**  
- switch  
- 16AX 250V~, type SP20  
- in accordance with EN 60669-1  
- screw contacts 1.5-2.5mm<sup>2</sup>

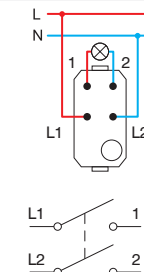

**MBYLLËSE ÇELËSI 1-0-2 16 A X 250 V~ 1M**



- SP40PC
- SP40PA
- SP40PB
- SP40PG

- çelësi
- 16 A X 250 V~, Iloji SP40
- në përputhje me EN 60669-1
- kontaktet e vidave 1,5-2,5 mm<sup>2</sup>

**SWITCH SHUTTERS 1-0-2 16AX 250V~ 1M**

- switch
- 16AX 250V~, type SP40
- in accordance with EN 60669-1
- screw contacts 1.5-2.5mm<sup>2</sup>

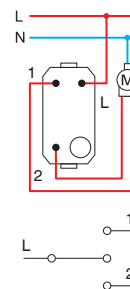

**MBYLLËSE BUTONI ME SHTYPJJE 1-0-2 16 A 250 V~ 1M**



- SP41PC
- SP41PA
- SP41PB
- SP41PG

- butoni me shtypje
- 16 A 250 V~, Iloji SP41
- në përputhje me EN 60669-1
- kontaktet e vidave 1,5-2,5 mm<sup>2</sup>

**PUSH BUTTON SHUTTERS 1-0-2 16A 250V~ 1M**

- push button
- 16A 250V~, type SP41
- in accordance with EN 60669-1
- screw contacts 1.5-2.5mm<sup>2</sup>

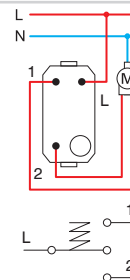

**ÇELËS ME 2 DREJTIME 16 A X 250 V~ 1M**



- SP60PC
- SP60PA
- SP60PB
- SP60PG

- çelësi
- 16 A X 250 V~, Iloji SP60
- në përputhje me EN 60669-1
- kontaktet e vidave 1,5-2,5 mm<sup>2</sup>

**SWITCH 2WAY 16AX 250V~ 1M**

- switch
- 16AX 250V~, type SP60
- in accordance with EN 60669-1
- screw contacts 1.5-2.5mm<sup>2</sup>

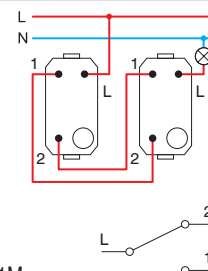

**BUTON ME SHTYPJJE ME 2 DREJTIME 16 A 250 V~ 1M**



- SP61PC
- SP61PA
- SP61PB
- SP61PG

- butoni me shtypje
- 16 A 250 V~, Iloji SP61
- në përputhje me EN 60669-1
- kontaktet e vidave 1,5-2,5 mm<sup>2</sup>

**PUSH BUTTON 2WAY 16A 250V~ 1M**

- push button
- 16A 250V~, type SP61
- in accordance with EN 60669-1
- screw contacts 1.5-2.5mm<sup>2</sup>

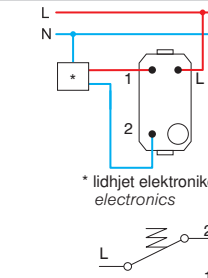

**ÇELËS NDËRMJETËS 16 A X 250 V~ 1M**



- SP70PC
- SP70PA
- SP70PB
- SP70PG

- çelësi
- 16 A X 250 V~, Iloji SP70
- në përputhje me EN 60669-1
- kontaktet e vidave 1,5-2,5 mm<sup>2</sup>

**SWITCH INTERMEDIATE 16AX 250V~ 1M**

- switch
- 16AX 250V~, type SP70
- in accordance with EN 60669-1
- screw contacts 1.5-2.5mm<sup>2</sup>

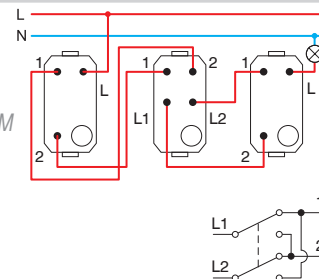

1M= 22,5 x 45

- SP10
- SP11
- SP12
- SP40
- SP41
- SP60
- SP61

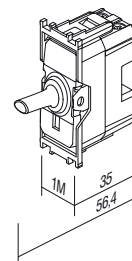

- SP20
- SP70

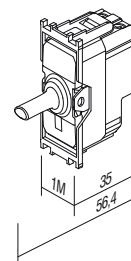



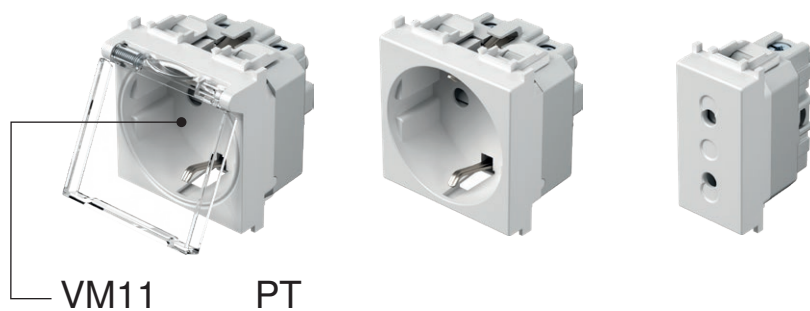

VM11

PT

lloji type	përshkrimi description	të dhënat teknike technical data	madhësia size	ngjyra colour																					
VM10	PRIZË SCHUKO+KS SOCKET SCHUKO+KS	2P+E 16A 250V~	2M	<table border="0"> <tr> <td><input type="checkbox"/> PW e bardhë polare polar white</td> <td><input checked="" type="checkbox"/> PT e bardhë+transparente white+transparent</td> <td><input type="checkbox"/> PP e bardhë+e bardhë white+white</td> </tr> </table>	<input type="checkbox"/> PW e bardhë polare polar white	<input checked="" type="checkbox"/> PT e bardhë+transparente white+transparent	<input type="checkbox"/> PP e bardhë+e bardhë white+white																		
<input type="checkbox"/> PW e bardhë polare polar white	<input checked="" type="checkbox"/> PT e bardhë+transparente white+transparent	<input type="checkbox"/> PP e bardhë+e bardhë white+white																							
VM11	PRIZË SCHUKO+KS+KAPAK SOCKET SCHUKO+KS+COVER	2P+E 16A 250V~	2M	<table border="0"> <tr> <td><input type="checkbox"/> MW e bardhë mat matte white</td> <td><input checked="" type="checkbox"/> MT e bardhë+transparente white+transparent</td> <td><input type="checkbox"/> MM e bardhë+e bardhë white+white</td> </tr> </table>	<input type="checkbox"/> MW e bardhë mat matte white	<input checked="" type="checkbox"/> MT e bardhë+transparente white+transparent	<input type="checkbox"/> MM e bardhë+e bardhë white+white																		
<input type="checkbox"/> MW e bardhë mat matte white	<input checked="" type="checkbox"/> MT e bardhë+transparente white+transparent	<input type="checkbox"/> MM e bardhë+e bardhë white+white																							
VM20	PRIZË EURO+KS SOCKET EURO+KS	2P 10A 250V~	1M	<table border="0"> <tr> <td><input checked="" type="checkbox"/> SB e zehtë soft touch soft touch black</td> <td><input checked="" type="checkbox"/> BT e zehtë+transparente soft touch black+transparent</td> <td><input checked="" type="checkbox"/> BB e zehtë+e zehtë soft touch black+black</td> </tr> <tr> <td><input checked="" type="checkbox"/> AT antracit anthracite</td> <td><input checked="" type="checkbox"/> AT antracit+transparente anthracite+transparent</td> <td><input checked="" type="checkbox"/> AA antracit+antracit anthracite+anthracite</td> </tr> <tr> <td><input checked="" type="checkbox"/> ES e argjendë elox elox silver</td> <td><input checked="" type="checkbox"/> ST e argjendë+transparente silver+transparent</td> <td><input checked="" type="checkbox"/> SS e argjendë+e argjendë silver+silver</td> </tr> <tr> <td><input checked="" type="checkbox"/> IW e bardhë fildishi ivory white</td> <td><input checked="" type="checkbox"/> IT e fildishtë+transparente ivory+transparent</td> <td><input checked="" type="checkbox"/> II e fildishtë+e fildishtë ivory+ivory</td> </tr> <tr> <td><input checked="" type="checkbox"/> RD e kuqe red</td> <td><input checked="" type="checkbox"/> RT e kuqe+transparente red+transparent</td> <td><input checked="" type="checkbox"/> RR e kuqe+e kuqe red+red</td> </tr> <tr> <td><input checked="" type="checkbox"/> GR e gjelbër green</td> <td><input checked="" type="checkbox"/> GT e gjelbër+transparente green+transparent</td> <td><input checked="" type="checkbox"/> GG e gjelbër+e gjelbër green+green</td> </tr> <tr> <td><input checked="" type="checkbox"/> OR portokalli orange</td> <td><input checked="" type="checkbox"/> OT portokalli+transparente orange+transparent</td> <td><input checked="" type="checkbox"/> OO portokalli+portokalli orange+orange</td> </tr> </table>	<input checked="" type="checkbox"/> SB e zehtë soft touch soft touch black	<input checked="" type="checkbox"/> BT e zehtë+transparente soft touch black+transparent	<input checked="" type="checkbox"/> BB e zehtë+e zehtë soft touch black+black	<input checked="" type="checkbox"/> AT antracit anthracite	<input checked="" type="checkbox"/> AT antracit+transparente anthracite+transparent	<input checked="" type="checkbox"/> AA antracit+antracit anthracite+anthracite	<input checked="" type="checkbox"/> ES e argjendë elox elox silver	<input checked="" type="checkbox"/> ST e argjendë+transparente silver+transparent	<input checked="" type="checkbox"/> SS e argjendë+e argjendë silver+silver	<input checked="" type="checkbox"/> IW e bardhë fildishi ivory white	<input checked="" type="checkbox"/> IT e fildishtë+transparente ivory+transparent	<input checked="" type="checkbox"/> II e fildishtë+e fildishtë ivory+ivory	<input checked="" type="checkbox"/> RD e kuqe red	<input checked="" type="checkbox"/> RT e kuqe+transparente red+transparent	<input checked="" type="checkbox"/> RR e kuqe+e kuqe red+red	<input checked="" type="checkbox"/> GR e gjelbër green	<input checked="" type="checkbox"/> GT e gjelbër+transparente green+transparent	<input checked="" type="checkbox"/> GG e gjelbër+e gjelbër green+green	<input checked="" type="checkbox"/> OR portokalli orange	<input checked="" type="checkbox"/> OT portokalli+transparente orange+transparent	<input checked="" type="checkbox"/> OO portokalli+portokalli orange+orange
<input checked="" type="checkbox"/> SB e zehtë soft touch soft touch black	<input checked="" type="checkbox"/> BT e zehtë+transparente soft touch black+transparent	<input checked="" type="checkbox"/> BB e zehtë+e zehtë soft touch black+black																							
<input checked="" type="checkbox"/> AT antracit anthracite	<input checked="" type="checkbox"/> AT antracit+transparente anthracite+transparent	<input checked="" type="checkbox"/> AA antracit+antracit anthracite+anthracite																							
<input checked="" type="checkbox"/> ES e argjendë elox elox silver	<input checked="" type="checkbox"/> ST e argjendë+transparente silver+transparent	<input checked="" type="checkbox"/> SS e argjendë+e argjendë silver+silver																							
<input checked="" type="checkbox"/> IW e bardhë fildishi ivory white	<input checked="" type="checkbox"/> IT e fildishtë+transparente ivory+transparent	<input checked="" type="checkbox"/> II e fildishtë+e fildishtë ivory+ivory																							
<input checked="" type="checkbox"/> RD e kuqe red	<input checked="" type="checkbox"/> RT e kuqe+transparente red+transparent	<input checked="" type="checkbox"/> RR e kuqe+e kuqe red+red																							
<input checked="" type="checkbox"/> GR e gjelbër green	<input checked="" type="checkbox"/> GT e gjelbër+transparente green+transparent	<input checked="" type="checkbox"/> GG e gjelbër+e gjelbër green+green																							
<input checked="" type="checkbox"/> OR portokalli orange	<input checked="" type="checkbox"/> OT portokalli+transparente orange+transparent	<input checked="" type="checkbox"/> OO portokalli+portokalli orange+orange																							



PRIZË SCHUKO+KS 2P+E 16 A 250 V~ 2M

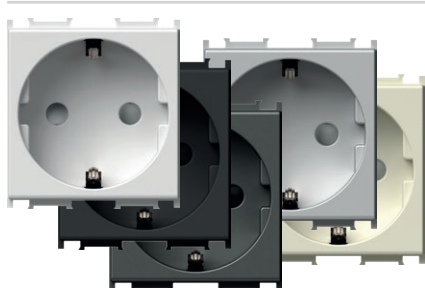

- VM10PW
- VM10MW
- VM10SB
- VM10AT
- VM10ES
- VM10IW

- 2P+E schuko
- 16 A 250 V~, lloji VM10
- në përputhje me IEC 60884-1, CEE7
- kontaktet e vidave 1,5-2,5 mm<sup>2</sup>
- kontaktet me rrymën të mbuluara

SOCKET SCHUKO+KS 2P+E 16A 250V~ 2M

- 2P+E schuko
- 16A 250V~, type VM10
- in accordance with IEC 60884-1, CEE7
- screw contacts 1.5-2.5 mm<sup>2</sup>
- shuttered live contacts



PRIZË SCHUKO+KS 2P+E 16 A 250 V~ 2M

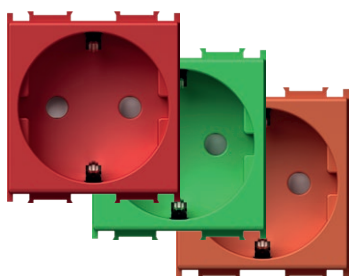

- VM10RD
- VM10GR
- VM10OR

- 2P+E schuko
- 16 A 250 V~, lloji VM10
- në përputhje me IEC 60884-1, CEE7
- kontaktet e vidave 1,5-2,5 mm<sup>2</sup>
- kontaktet me rrymën të mbuluara

SOCKET SCHUKO+KS 2P+E 16A 250V~ 2M

- 2P+E schuko
- 16A 250V~, type VM10
- in accordance with IEC 60884-1, CEE7
- screw contacts 1.5-2.5 mm<sup>2</sup>
- shuttered live contacts



PRIZË SCHUKO+KS+KAPAK 2P+E 16 A 250 V~ 2M

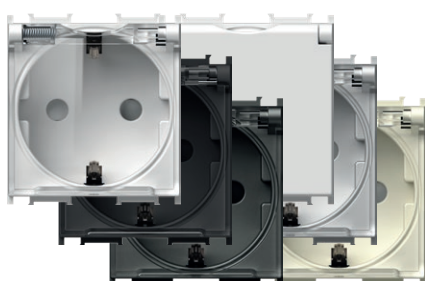

- VM11PT
- VM11MT
- VM11BT
- VM11AT
- VM11ST
- VM11IT
- VM11PP

- 2P+E schuko+kapak
- 16 A 250 V~, lloji VM11
- në përputhje me IEC 60884-1, CEE7
- kontaktet e vidave 1,5-2,5 mm<sup>2</sup>
- kontaktet me rrymën të mbuluara

SOCKET SCHUKO+KS+COVER

- 2P+E 16A 250V~ 2M
- 2P+E schuko+cover
- 16A 250V~, type VM11
- in accordance with IEC 60884-1, CEE7
- screw contacts 1.5-2.5 mm<sup>2</sup>
- shuttered live contacts



## S O C K E T S V M

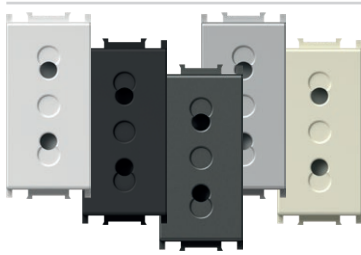

- VM20PW
- VM20MW
- VM20SB
- VM20AT
- VM20ES
- VM20IW

## PRIZË EURO+KS 2P 10A 250 V~ 1M

- 2P Euro
- 10A 250 V~, lloji VM20
- në përputhje me IEC 60884-1, CEE7
- kontaktet e vidave 1.5-2.5 mm<sup>2</sup>
- kontaktet me rrymën të mbuluara

## SOCKET EURO+KS 2P 10A 250V~ 1M

- 2P Euro
- 10A 250V~, type VM20
- in accordance with IEC 60884-1, CEE7
- screw contacts 1.5-2.5 mm<sup>2</sup>
- shuttered live contacts

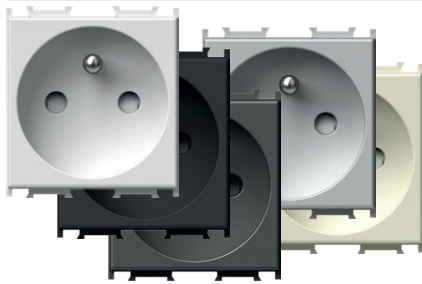

- VM40PW
- VM40MW
- VM40SB
- VM40AT
- VM40ES
- VM40IW

## PRIZË FRANCEZE+KS 2P+E 16 A 250 V~ 2M

- 2P+E Franceze
- 16 A 250 V~, lloji VM40
- në përputhje me IEC 60884-1, NF C 61-314, CEE7
- kontaktet e vidave 1.5-2.5 mm<sup>2</sup>
- kontaktet me rrymën të mbuluara

## SOCKET FRENCH+KS 2P+E 16A 250V~ 2M

- 2P+E French
- 16A 250V~, type VM40
- in accordance with IEC 60884-1, NF C 61-314, CEE7
- screw contacts 1.5-2.5 mm<sup>2</sup>
- shuttered live contacts

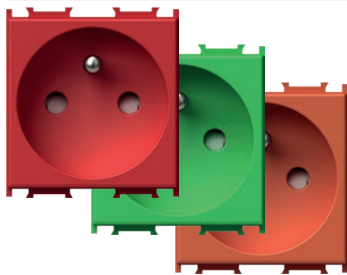

- VM40RD
- VM40GR
- VM40OR

## PRIZË FRANCEZE+KS 2P+E 16 A 250 V~ 2M

- 2P+E Franceze
- 16 A 250 V~, lloji VM40
- në përputhje me IEC 60884-1, NF C 61-314, CEE7
- kontaktet e vidave 1.5-2.5 mm<sup>2</sup>
- kontaktet me rrymën të mbuluara

## SOCKET FRENCH+KS 2P+E 16A 250V~ 2M

- 2P+E French
- 16A 250V~, type VM40
- in accordance with IEC 60884-1, NF C 61-314, CEE7
- screw contacts 1.5-2.5 mm<sup>2</sup>
- shuttered live contacts



- VM41PT
- VM41MT
- VM41BT
- VM41AT
- VM41PP
- VM41ST
- VM41IT

## PRIZË FRANCEZE+KS+KAPAK 2P+E 16 A 250 V~ 2M

- 2P+E Franceze+kapak
- 16 A 250 V~, lloji VM41
- në përputhje me IEC 60884-1, NF C 61-314, CEE7
- kontaktet e vidave 1.5-2.5 mm<sup>2</sup>
- kontaktet me rrymën të mbuluara

## SOCKET FRENCH+KS+COVER

- 2P+E 16A 250V~ 2M
- 2P+E French+cover
- 16A 250V~, type VM41
- in accordance with IEC 60884-1, NF C 61-314, CEE7
- screw contacts 1.5-2.5 mm<sup>2</sup>
- shuttered live contacts

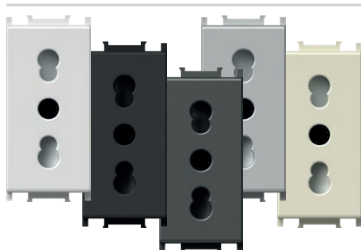

- VM30PW
- VM30MW
- VM30SB
- VM30AT
- VM30ES
- VM30IW

## PRIZË ITALIANE P17/11+KS 2P+E 16 A 250 V~ 1M

- 2P+E Italiane P17/11
- 16 A 250 V~, lloji VM30
- në përputhje me IEC 60884-1, CEI 23-50
- kontaktet e vidave 1.5-2.5 mm<sup>2</sup>
- kontaktet me rrymën të mbuluara

## SOCKET ITALIAN P17/11+KS 2P+E 16A 250V~ 1M

- 2P+E Italian P17/11
- 16A 250V~, type VM30
- in accordance with IEC 60884-1, CEI 23-50
- screw contacts 1.5-2.5 mm<sup>2</sup>
- shuttered live contacts

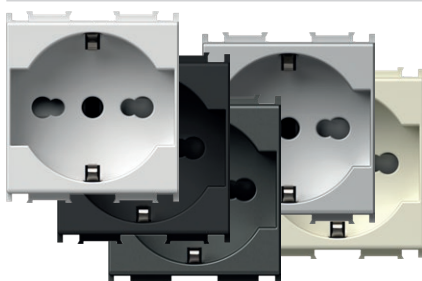

- VM31PW
- VM31MW
- VM31SB
- VM31AT
- VM31ES
- VM31IW

## PRIZË SCHUKO/ITALIANE P17/11+KS 2P+E 16 A 250 V~ 2M

- 2P+E Schuko/Italiane P17/11
- 16 A 250 V~, lloji VM31
- në përputhje me IEC 60884-1, CEI 23-50
- kontaktet e vidave 1.5-2.5 mm<sup>2</sup>
- kontaktet me rrymën të mbuluara

## SOCKET SCHUKO/ITA P17/11+KS

- 2P+E 16A 250V~ 2M
- 2P+E schuko/Italian P17/11
- 16A 250V~, type VM31
- in accordance with IEC 60884-1, CEI 23-50
- screw contacts 1.5-2.5 mm<sup>2</sup>
- shuttered live contacts

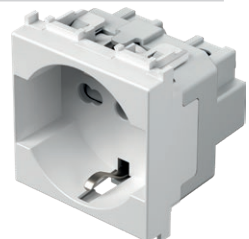



PRIZË SCHUKO/ITALIANE P30+KS 2P+E 16 A 250 V~ 2M

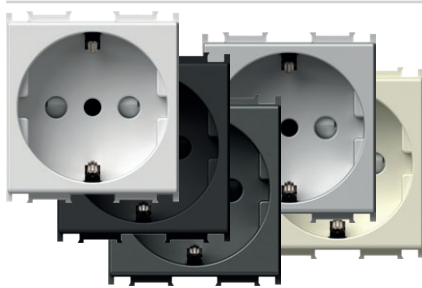

- VM32PW
- VM32MW
- VM32SB
- VM32AT
- VM32ES
- VM32IW

- 2P+E Schuko/Italiane P30
- 16 A 250 V~, Iloji VM32
- në përputhje me IEC 60884-1, CEI 23-50
- kontaktet e vidave 1,5-2,5 mm<sup>2</sup>
- kontaktet me rrymën të mbuluara



SOCKET SCHUKO/ITA P30+KS 2P+E 16A 250V~ 2M

- 2P+E schuko/Italian P30
- 16A 250V~, type VM32
- in accordance with IEC 60884-1, CEI 23-50
- screw contacts 1.5-2.5 mm<sup>2</sup>
- shuttered live contacts

PRIZË ITALIANE P11+KS 2P+E 10A 250 V~ 1M

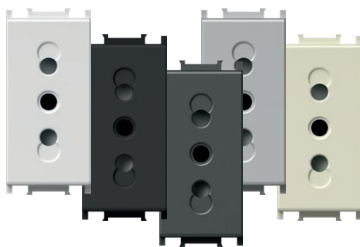

- VM33PW
- VM33MW
- VM33SB
- VM33AT
- VM33ES
- VM33IW

- 2P+E Italiane P11
- 10A 250 V~, Iloji VM33
- në përputhje me IEC 60884-1, CEI 23-50
- kontaktet e vidave 1,5-2,5 mm<sup>2</sup>
- kontaktet me rrymën të mbuluara



SOCKET ITALIAN P11+KS 2P+E 10A 250V~ 1M

- 2P+E Italian P11
- 10A 250V~, type VM33
- in accordance with IEC 60884-1, CEI 23-50
- screw contacts 1.5-2.5 mm<sup>2</sup>
- shuttered live contacts

PRIZË EURO/AMERIKANE+KS 2P 16A 250 V~ 1M

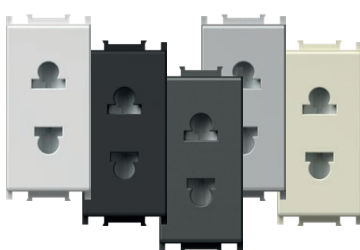

- VM21PW
- VM21MW
- VM21SB
- VM21AT
- VM21ES
- VM21IW

- 2P Euro/Amerikane
- 16 A 250 V~, Iloji VM21
- kontaktet e vidave 1,5-2,5 mm<sup>2</sup>
- kontaktet me rrymën të mbuluara
- vetëm për vendet jashtë BE-së



SOCKET EURO/AMERICAN+KS 2P 16A 250V~ 1M

- 2P Euro/American
- 16A 250V~, type VM21
- screw contacts 1.5-2.5 mm<sup>2</sup>
- shuttered live contacts
- only for countries not members of EU

PRIZË BRITANIKE BS 1363-2+KS 2P+E 13 A 250 V~ 2M

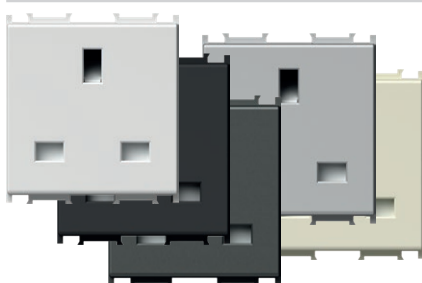

- VM52PW
- VM52MW
- VM52SB
- VM52AT
- VM52ES
- VM52IW

- 2P+E Britanike BS 1363-2
- 13 A 250 V~, Iloji VM52
- në përputhje me BS 1363-2
- kontaktet e vidave 1,5-4 mm<sup>2</sup>
- kontaktet me rrymën të mbuluara

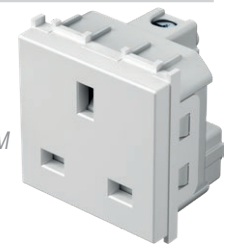

SOCKET BRITISH BS 1363-2+KS 2P+E 13A 250V~ 2M

- 2P+E British BS 1363-2
- 13A 250V~, type VM52
- in accordance with BS 1363-2
- screw contacts 1.5-4 mm<sup>2</sup>
- shuttered live contacts

PRIZA MULTISTANDARDE+KS 2P+E 13A 250V~ 2M

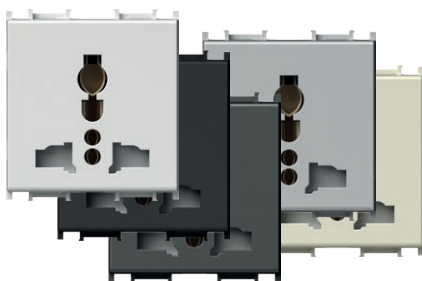

- VM55PW
- VM55MW
- VM55SB
- VM55AT
- VM55ES
- VM55IW

- kontakte spinash 1,5-2,5 mm<sup>2</sup>
  - kontaktet me rrymën të mbuluara
- SOCKET MULTI-STANDARD+KS 2P+E 13A 250V~ 2M
- plug-in contacts 1.5-2.5 mm<sup>2</sup>
  - shuttered live contacts



MBROJTËS NGA MBIRRYMA MPE MINI 275 V/50 Hz



VM80

- lidhje paralele me prizën e parë në radhë
- mbrojtje e klasit III
- Uc=275 V ac, Uoc/Isc=6 kV/3 kA, Up<800 V
- në përputhje me IEC 61643-1
- telat 1,5 mm<sup>2</sup>, IP20
- sinjalistik gjatë shkëputjes





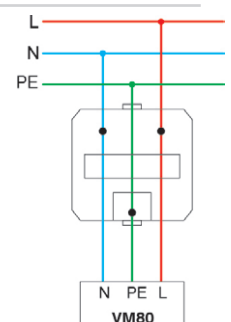





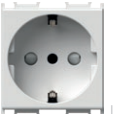

SURGE PROTECTOR MPE MINI 275V/50Hz

- parallel connection with the first socket in the row
- protection class III
- Uc=275V~, Uoc/Isc=6kV/3kA, Up<800V
- in accordance with IEC 61643-1
- wires 1.5mm<sup>2</sup>, IP20
- sound signal at breakdown







## S O C K E T S V M

PËRSHTATJE E PRIZAVE DHE SPINAVE  
SOCKETS AND PLUGS MATCHING

PRIZA / SOCKET									
LLOJI I SPINËS / PLUG STYLE	VM10 VM11	VM20	VM30	VM33	VM31	VM32	VM40 VM41	VM21	VM55
Gjermane / German 	•				•	•			•
Franceze / French 	•				•	•	•		•
Italiane / Italian S11 			•	•	•	•			•
Italiane / Italian S17 			•		•				•
Euro 	•	•	•		•	•	•	•	•

PËRSHTATJE E PRIZAVE DHE SPINAVE  
SOCKETS AND PLUGS MATCHING

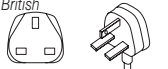
PRIZA / SOCKET			
LLOJI I SPINËS / PLUG STYLE	VM21	VM52	VM55
Amerikane / American 	•		•
Britanike / British BS 1363-2 		•	•

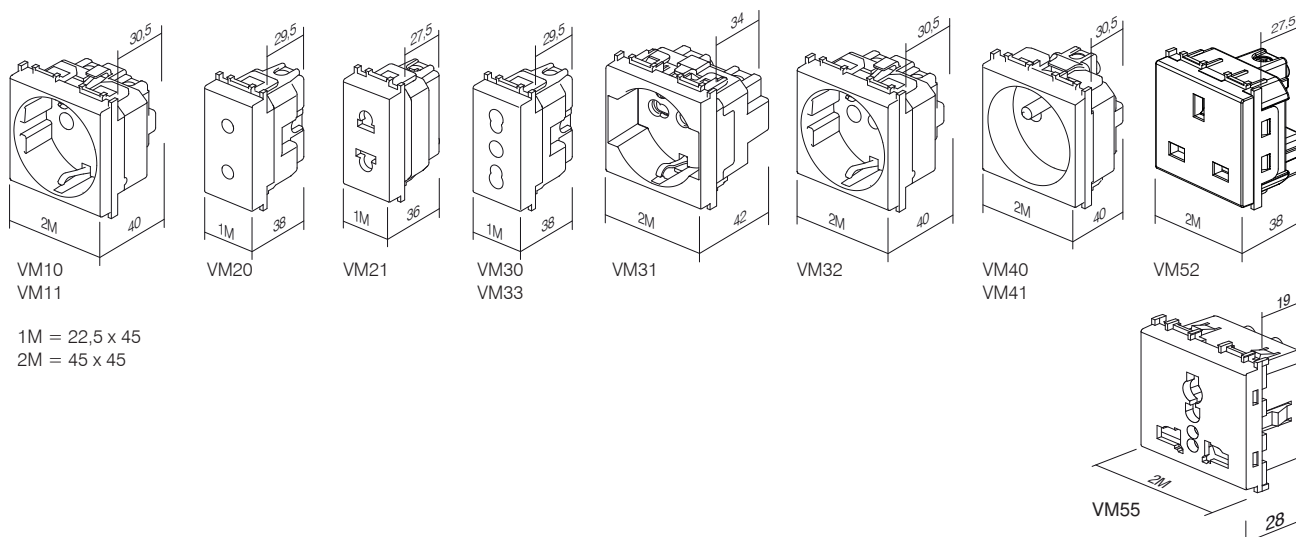





Iloji type	përshkrimi description	të dhënat teknike technical data	madhësia size	ngjyra colour
KM10	PRIZË TV BAZË SOCKET TV BASIC	0dB	1M	<input type="checkbox"/> PW e bardhë polare polar white
KM11	PRIZË TV ME KAPAK FUNDOR SOCKET TV END-LINE	1dB	1M	<input type="checkbox"/> MW e bardhë mat matte white
KM12	PRIZË TV KALUESE SOCKET TV TROUGH PASS	10dB	1M	<input checked="" type="checkbox"/> SB e zezë soft touch soft touch black
⋮	⋮	⋮	⋮	<input checked="" type="checkbox"/> AT antracit anthracite
⋮	⋮	⋮	⋮	<input type="checkbox"/> ES e argjendtë elox elox silver
⋮	⋮	⋮	⋮	<input type="checkbox"/> IW e bardhë fildishi ivory white

PRIZË TV BAZË 0dB 1M



- KM10PW
- KM10MW
- KM10SB
- KM10AT
- KM10ES
- KM10IW

- TV bazë
  - reduktim 0dB
  - lidhje e pasme – F standarde
- SOCKET TV BASIC 0dB 1M
- TV basic
  - reduction 0dB
  - back connector – F standard



PRIZË TV BAZË 0dB 2M

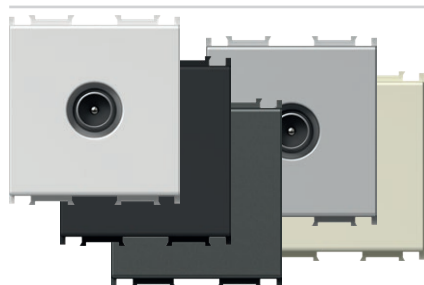

- KM20PW
- KM20MW
- KM20SB
- KM20AT
- KM20ES
- KM20IW

- TV bazë
  - reduktim 0dB
  - lidhje e pasme – F standarde
- SOCKET TV BASIC 0dB 2M
- TV basic
  - reduction 0dB
  - back connector – F standard



PRIZË TV ME KAPAK FUNDOR 1dB 1M



- KM11PW
- KM11MW
- KM11SB
- KM11AT
- KM11ES
- KM11IW

- TV me kapak fundor
  - gama e frekuencës 5÷2400 MHz
  - reduktimi < 1 dB
  - në përputhje me EN 50083-1
  - kontaktet e vidave
- SOCKET TV END-LINE 1dB 1M
- TV end-line
  - frequency range 5÷2400 MHz
  - reduction < 1 dB
  - in accordance with EN 50083-1
  - screw contacts

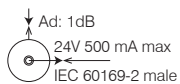

## PRIZË TV KALUESE 10dB 1M



- KM12PW
- KM12MW
- KM12SB
- KM12AT
- KM12ES
- KM12IW

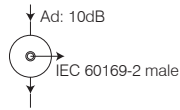

- TV kaluese
- gama e frekuencës 5÷2400 MHz
- reduktimi < 10 dB
- në përputhje me EN 50083-1
- kontaktet e vidave

## SOCKET TV TROUGHPASS 10dB 1M

- TV troughpass
- frequency range 5÷2400 MHz
- reduction < 10 dB
- in accordance with EN 50083-1
- screw contacts



## PRIZË SAT BAZË 0dB 1M



- KM15PW
- KM15MW
- KM15SB
- KM15AT
- KM15ES
- KM15IW

- SAT bazë
- reduktim 0dB
- lidhje e pasme – F standarde

## SOCKET SAT BASIC 0dB 1M

- SAT basic
- reduction 0dB
- back connector – F standard



## PRIZË SAT BAZË 0dB 2M

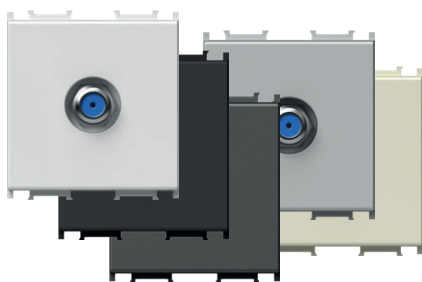

- KM24PW
- KM24MW
- KM24SB
- KM24AT
- KM24ES
- KM24IW

- SAT bazë
- reduktim 0dB
- lidhje e pasme – F standarde

## SOCKET SAT BASIC 0dB 2M

- SAT basic
- reduction 0dB
- back connector – F standard



## PRIZË SAT ME KAPAK FUNDOR 1dB 1M



- KM16PW
- KM16MW
- KM16SB
- KM16AT
- KM16ES
- KM16IW

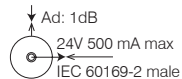

- SAT me kapak fundor
- gama e frekuencës 5÷2400 MHz
- reduktim < 0dB
- në përputhje me EN 50083-1
- kontaktet e vidave

## SOCKET SAT END-LINE 1dB 1M

- SAT end-line
- frequency range 5÷2400 MHz
- reduction < 1dB
- in accordance with EN 50083-1
- screw contacts





PRIZË R BAZË 0dB 1M



- KM19PW
- KM19MW
- KM19SB
- KM19AT
- KM19ES
- KM19IW

- R bazë
- reduktim 0dB
- lidhje e pasme – F standarde

SOCKET R BASIC 0dB 1M

- R basic
- reduction 0dB
- back connector – F standard



PRIZË R BAZË 0dB 2M

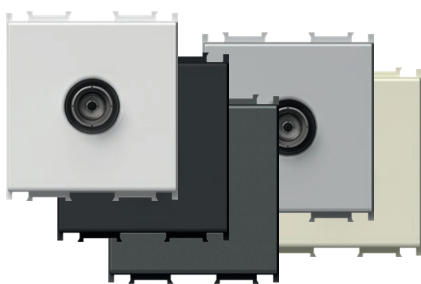

- KM29PW
- KM29MW
- KM29SB
- KM29AT
- KM29ES
- KM29IW

- R bazë
- reduktim 0dB
- lidhje e pasme – F standarde

SOCKET R BASIC 0dB 2M

- R basic
- reduction 0dB
- back connector – F standard



PRIZË SAT-TV ME KAPAK FUNDOR 1dB 1M



- KM17PW
- KM17MW
- KM17SB
- KM17AT
- KM17ES
- KM17IW

- SAT-TV me kapak fundor
- gama e frekuencës 5÷2400 MHz
- reduktim < 0dB
- në përputhje me EN 50083-1
- kontaktet e vidave

SOCKET SAT-TV END-LINE 1dB 1M

- SAT-TV end-line
- frequency range 5÷2400 MHz
- reduction < 1dB
- in accordance with EN 50083-1
- screw contacts

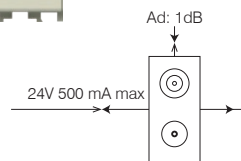

## SHEMBUJ TË LIDHJEVE BAZË

### BASIC CONNECTION SAMPLES

lidhje individuale  
stand alone connection

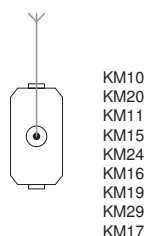

KM10  
KM20  
KM11  
KM15  
KM24  
KM16  
KM19  
KM29  
KM17

lidhje yll  
star connection

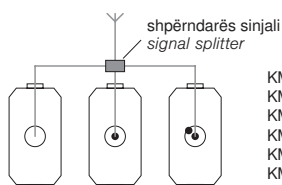

shpërndarës sinjali  
signal splitter

KM10  
KM20  
KM11  
KM15  
KM24  
KM16  
KM19  
KM29  
KM17

lidhje kaluese  
throughpass connection

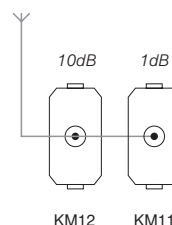

10dB 1dB  
KM12 KM11

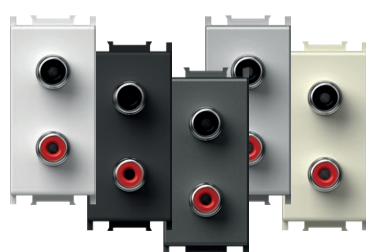

- KM22PW
- KM22MW
- KM22SB
- KM22AT
- KM22ES
- KM22IW

### PRIZË AUDIO 2xRCA 1M

- audio 2x RCA
- lidhje me ngjitje e kablos në pjesën e pasme

#### SOCKET AUDIO 2xRCA 1M

- audio 2x RCA
- soldering connection of cable at the back side



- KM23PW
- KM23MW
- KM23SB
- KM23AT
- KM23ES
- KM23IW

### PRIZË AUDIO ALTOPARLANTË 1M

- audio 2x Ø4mm
- për të mbajtur telin e altoparlantit, spinë banane Ø4mm ose pirun
- lidhje me ngjitje e kablos në pjesën e pasme

#### SOCKET AUDIO LOUDSPEAKERS 1M

- audio 2x Ø4mm
- to accommodate speaker wire, banana plug Ø4mm or spades
- soldering connection of cable at the back side



- KM26PW
- KM26MW
- KM26SB
- KM26AT
- KM26ES
- KM26IW

### PRIZË AUDIO ALTOPARLANTË 2M

- audio 2x Ø4mm
- për të mbajtur telin e altoparlantit, spinë banane Ø4mm ose pirun
- lidhje me ngjitje e kablos në pjesën e pasme

#### SOCKET AUDIO LOUDSPEAKERS 2M

- audio 2x Ø4mm
- to accommodate speaker wire, banana plug Ø4mm or spades
- soldering connection of cable at the back side



1M = 22,5 x 45  
2M = 45 x 45

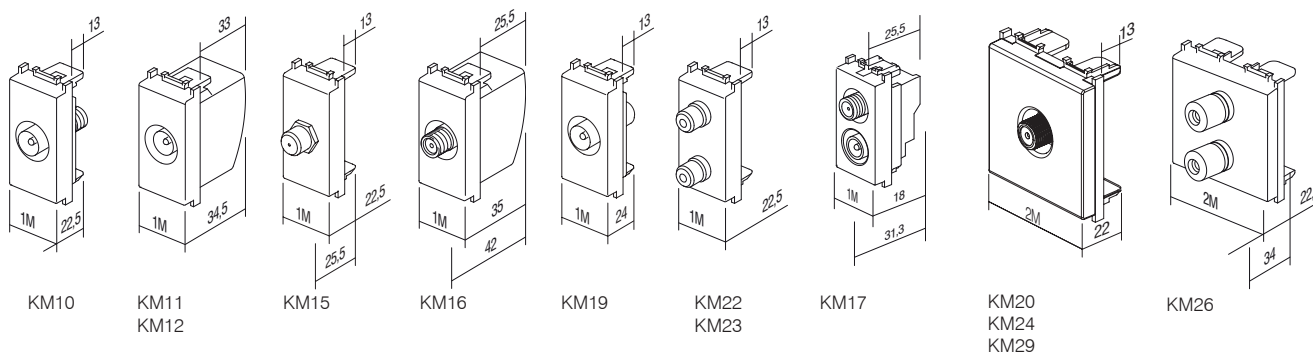



PRIZË TEL LT RJ11 6/4 1M



- KM30PW
- KM30MW
- KM30SB
- KM30AT
- KM30ES
- KM30IW

- vidë TEL LT  
- RJ11 6/4  
- në përputhje me IEC 60603-7  
- kontaktet e vidave

*SOCKET TEL LT RJ11 6/4 1M*

- TEL LT screw  
- RJ11 6/4  
- in accordance with IEC 60603-7  
- screw contacts



PRIZË TEL BT SEC 6/6 1M

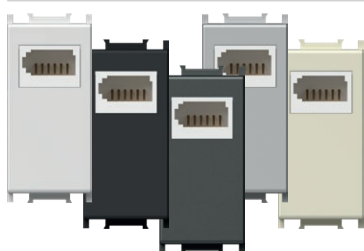

- KM31PW
- KM31MW
- KM31SB
- KM31AT
- KM31ES
- KM31IW

- TEL BT Britanike standarde  
- SEC dytësore 6/6  
- në përputhje me BS 6312  
- kontaktet e vidave

*SOCKET TEL BT SEC 6/6 1M*

- TEL BT British standard  
- SEC secondary 6/6  
- in accordance with BS 6312  
- screw contacts



PRIZË TEL KS RJ11 6/4 1M

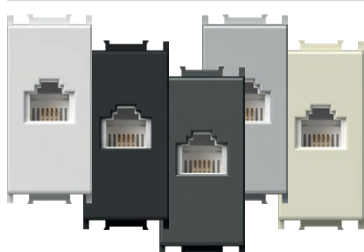

- KM36PW
- KM36MW
- KM36SB
- KM36AT
- KM36ES
- KM36IW

- standard fiksues trapez KS  
- RJ11 6/4  
- në përputhje me IEC 60603-7

*SOCKET TEL KS RJ11 6/4 1M*

- KS keystone fixing standard  
- RJ11 6/4  
- in accordance with IEC 60603-7

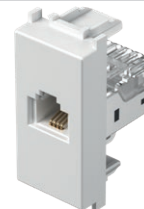

PRIZË CAT5e KS RJ45 8/8 1M

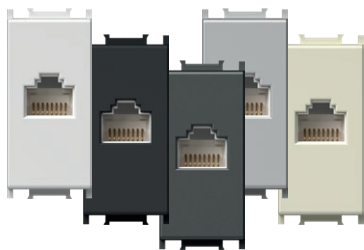

- KM37PW
- KM37MW
- KM37SB
- KM37AT
- KM37ES
- KM37IW

- standard fiksues trapez KS  
- CAT5e, RJ45 8/8  
- në përputhje me IEC 60603-7

*SOCKET CAT5e KS RJ45 8/8 1M*

- KS keystone fixing standard  
- CAT5e, RJ45 8/8  
- in accordance with IEC 60603-7



PËRSHTATËS KS 1M

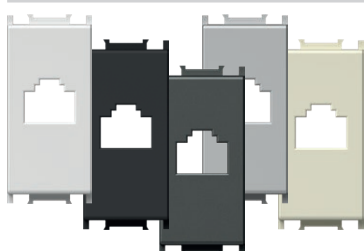

- KM35PW
- KM35MW
- KM35SB
- KM35AT
- KM35ES
- KM35IW

- standard fiksues trapez KS  
- AMP, Avaya, Brandrex, FMT, Mfico, Tyco, ...  
- moduli i komunikimit nuk përfshihet

*ADAPTER KS 1M*

- KS keystone fixing standard  
- AMP, Avaya, Brandrex, FMT, Mfico, Tyco, ...  
- communication module not included

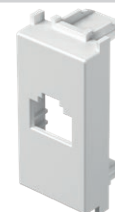

PËRSHTATËS KS ME MBROJTJE NGA PLUHURI 1M

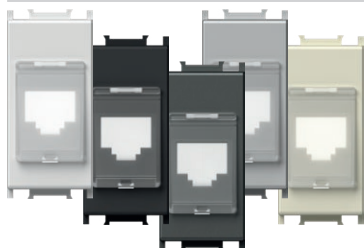

- KM38PW
- KM38MW
- KM38SB
- KM38AT
- KM38ES
- KM38IW

- standard fiksues trapez KS me mbrojtje nga pluhuri  
- AMP, Avaya, Brandrex, FMT, Mfico, Tyco, ...  
- moduli i komunikimit nuk përfshihet

*ADAPTER KS WITH DUST PROTECTION 1M*

- KS keystone fixing standard with dust protection  
- AMP, Avaya, Brandrex, FMT, Mfico, Tyco, ...  
- communication module not included



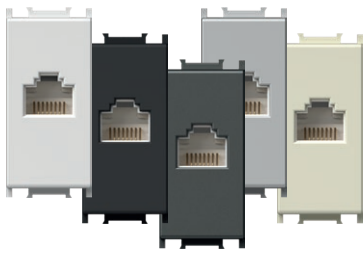

- KM39PW
- KM39MW
- KM39SB
- KM39AT
- KM39ES
- KM39IW

#### PRIZË CAT6 SCH KS RJ45 8/8 1M

- standard fiksues trapez KS
- CAT6 UTP pa vegla, RJ45 8/8
- në përputhje me ISO/IEC 11801

#### SOCKET CAT6 SCH KS RJ45 8/8 1M

- KS keystone fixing standard
- CAT6 UTP toolless, RJ45 8/8
- in accordance with ISO/IEC 11801

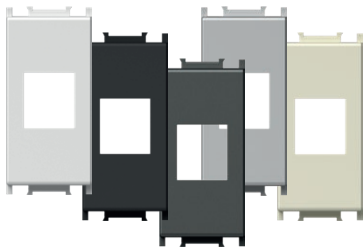

- KM50PW
- KM50MW
- KM50SB
- KM50AT
- KM50ES
- KM50IW

#### PËRSHTATËS KS UNIVERSAL 1M

- standard fiksues trapez KS
- i përshatshëm për HDMI, USB
- moduli i komunikimit nuk përfshihet

#### ADAPTER KS UNIVERSAL 1M

- KS keystone fixing standard
- suitable for HDMI, USB
- communication module not included

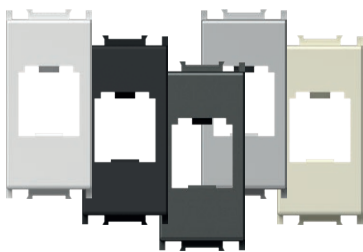

- KM40PW
- KM40MW
- KM40SB
- KM40AT
- KM40ES
- KM40IW

#### PËRSHTATËS PD 1M

- standard fiksues PD Panduit Mini-COM
- moduli i komunikimit nuk përfshihet

#### ADAPTER PD 1M

- PD Panduit Mini-COM fixing standard
- communication module not included



- KM43PW
- KM43MW
- KM43SB
- KM43AT
- KM43ES
- KM43IW

#### PËRSHTATËS PD ME MBROJTJE NGA PLUHURI 1M

- standard fiksues PD Panduit Mini-COM me mbrojtje nga pluhuri
- moduli i komunikimit nuk përfshihet

#### ADAPTER PD WITH DUST PROTECTION 1M

- PD Panduit Mini-COM fixing standard with dust protection
- communication module not included







## PËRSHTATËS LK 1M

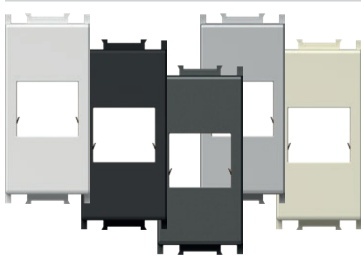

- KM45PW
- KM45MW
- KM45SB
- KM45AT
- KM45ES
- KM45IW

- standard fiksues LK LeoniKerpen eLine / BKS NewLine  
- moduli i komunikimit nuk përfshihet

## ADAPTER LK 1M

- LK LeoniKerpen eLine / BKS NewLine fixing standard  
- communication module not included



## PËRSHTATËS NEXANS/SCHRACK 2M

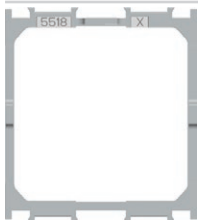

KA26

- përshtatës fiksues për Nexans LANmark dhe LANmark në Schrack velikosti 45x45 mm  
- modul Schrack 45x45 mm  
- e përshtatshme për Schrack llojin HSEMD02W2F  
- moduli i komunikimit nuk përfshihet

## ADAPTER NEXANS/SCHRACK 2M

- fixing adapter for Nexans LANmark and Schrack module 45x45mm  
- suitable for Nexans type N423.540N  
- suitable for Schrack type HSEMD02W2F  
- communication module not included

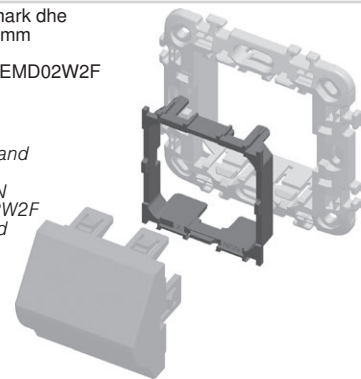

## PËRSHTATËS AT&amp;T SYSTIMAX ME MBROJTJE NGA PLUHURI 1M



- KM48PW
- KM48MW
- KM48SB
- KM48AT
- KM48ES
- KM48IW

- standard fiksues AT&T Systimax me mbrojtje nga pluhuri  
- moduli i komunikimit nuk përfshihet

## ADAPTER AT&amp;T SYSTIMAX WITH DUST PROTECTION 1M

- AT&T Systimax fixing standard with dust protection  
- communication module not included



## PRIZË USB LLOJI A 1M



- KM51PW
- KM51MW
- KM51SB
- KM51AT
- KM51ES
- KM51IW

- prizë USB 2.0 lloji A  
- kontaktet e vidave, raster 5 mm, 1,5 mm<sup>2</sup>, 1x2P + 1x3P  
- lidhjet elektrike:  
KUNJI 1 – VCC (+5V, teli i kuq)  
KUNJI 2 – Të dhëna - (teli i bardhë)  
KUNJI 3 – Të dhëna + (teli i gjelbër)  
KUNJI 4 – GND - tokëzimi (teli i zi)  
S – mbrojtja  
- në përputhje me direktivën 2011/95/EU (RoHS2)

## SOCKET USB TYPE A 1M

- USB 2.0 socket type A  
- screw contacts, raster 5 mm, 1,5 mm<sup>2</sup>, 1x2P + 1x3P  
- wiring:  
PIN 1 – VCC (+5V, red wire)  
PIN 2 – Data - (white wire)  
PIN 3 – Data + (green wire)  
PIN 4 – GND - ground (black wire)  
S – shield  
- in accordance with directive 2011/95/EU (RoHS2)



1M = 22,5 x 45  
2M = 45 x 45

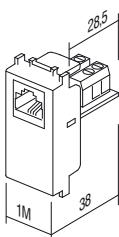

KM30

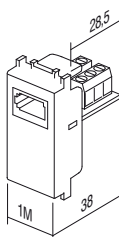

KM31

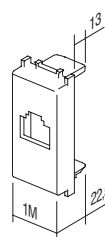
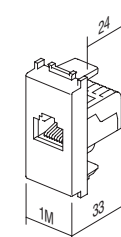
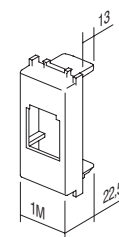
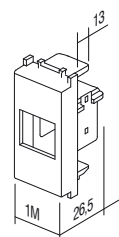
KM35  
KM38  
KM48KM36  
KM37  
KM39KM40  
KM43

KM45

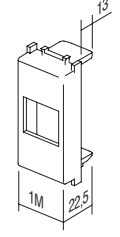
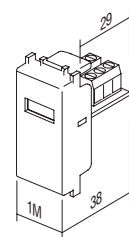
KM46  
KM47  
KM50  
KM52  
KM53

KM51



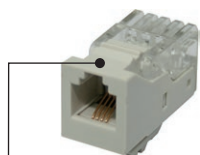

**KA10**

Iloji type	përshkrimi description	të dhënat teknike technical data
KA10	KONEKTORI KS CAT3 CONNECTOR KS CAT3	RJ11 6/4
KA11	KONEKTORI KS CAT5e CONNECTOR KS CAT5e	RJ45 8/8
KA12	KONEKTORI KS CAT5eS CONNECTOR KS CAT5eS	RJ45 8/8
⋮	⋮	⋮



**KONEKTORI KS CAT3 RJ11 6/4**

KA10

- standard fiksues trapez KS
- CAT3, RJ11 6/4
- në përputhje me IEC 60603-7

*CONNECTOR KS CAT3 RJ11 6/4*

- KS keystone fixing standard
- CAT3, RJ11 6/4
- in accordance with IEC 60603-7



**KONEKTORI KS CAT5e RJ45 8/8**

KA11

- standard fiksues trapez KS
- CAT5e, RJ45 8/8
- në përputhje me IEC 60603-7

*CONNECTOR KS CAT5e RJ45 8/8*

- KS keystone fixing standard
- CAT5e, RJ45 8/8
- in accordance with IEC 60603-7



**KONEKTORI KS CAT5eS RJ45 8/8**

KA12

- standard fiksues trapez KS
- CAT5eS, RJ45 8/8
- në përputhje me IEC 60603-7

*CONNECTOR KS CAT5eS RJ45 8/8*

- KS keystone fixing standard
- CAT5eS, RJ45 8/8
- in accordance with IEC 60603-7



KA15

## KONEKTORI KS CAT6 SCH RJ45 8/8

- standard fiksues trapez KS
- CAT6 UTP pa vegla, RJ45 8/8
- në përputhje me ISO/IEC 11801

*CONNECTOR KS CAT6 SCH RJ45 8/8*

- KS keystone fixing standard
- CAT6 UTP toolless, RJ45 8/8
- in accordance with ISO/IEC 11801



KA16

## KONEKTORI KS CAT6S SCH RJ45 8/8

- standard fiksues trapez KS
- CAT6S STP pa vegla, RJ45 8/8
- në përputhje me ISO/IEC 11801

*CONNECTOR KS CAT6S SCH RJ45 8/8*

- KS keystone fixing standard
- CAT6S STP toolless, RJ45 8/8
- in accordance with ISO/IEC 11801



KA17

## KONEKTORI KS CAT6a SCH RJ45 8/8

- standard fiksues trapez KS
- CAT6a STP pa vegla, RJ45 8/8
- në përputhje me ISO/IEC 11801

*CONNECTOR KS CAT6a SCH RJ45 8/8*

- KS keystone fixing standard
- CAT6a STP toolless, RJ45 8/8
- in accordance with ISO/IEC 11801



KA18

## KONEKTORI SLIM KS CAT6S SCH RJ45 8/8

- standard fiksues trapez KS
- stil slim
- CAT6S STP pa vegla, RJ45 8/8
- në përputhje me ISO/IEC 11801
- i përshatshëm edhe për përshatës dysh KE46

*CONNECTOR SLIM KS CAT6S SCH RJ45 8/8*

- KS keystone fixing standard
- slim style
- CAT6S STP toolless, RJ45 8/8
- in accordance with ISO/IEC 11801
- suitable also for KE46 double adapter



KA27

## KONEKTORI KS HDMI

- standard fiksues trapez KS
- vetëm në kombinim me përshatësin KM50
- HDMI/HDMI

*CONNECTOR KS HDMI*

- KS keystone fixing standard
- only in combination with adapter KM50
- HDMI/HDMI



KA28

## KABLOJA KS HDMI

- standard fiksues trapez KS
- vetëm në kombinim me përshatësin KM50
- HDMI/HDMI

*CABLE KS HDMI*

- KS keystone fixing standard
- only in combination with adapter KM50
- HDMI/HDMI





EM33



PW



Iloji type	përshkrimi description	të dhënat teknike technical data	madhësia size	ngjyra colour	
EM12	REOSTAT RROTULLUES/2 DREJTIME DIMMER ROTATIVE 2WAY	RL 300W	1M	<input type="checkbox"/> PW e bardhë polare polar white <input type="checkbox"/> MW e bardhë mat matte white <input type="checkbox"/> SB e zezë soft touch soft touch black <input type="checkbox"/> AT antracit anthracite <input type="checkbox"/> ES e argjendtë elox elox silver <input type="checkbox"/> IW e bardhë fildishi ivory white	<input type="checkbox"/> BL blu blue <input type="checkbox"/> RD e kuqe red <input type="checkbox"/> GR e gjelbër green <input type="checkbox"/> OR portokalli orange <input type="checkbox"/> RG e kuqe/e gjelbër red/green
EM23	REOSTAT ME MONTIM NË KUTI DIMMER INBOX	R (250 W), (RC,RL 200VA)	/		
.	.	.	.		
.	.	.	.		

REOSTAT RROTULLUES/2 DREJTIME RL 300W 1M



- EM12PW
- EM12MW
- EM12SB
- EM12AT
- EM12ES
- EM12IW

- kontroll i rrotullimit me çelësin me 2 drejtime
- RL i ngarkesës, 40 W - 300 W
- tensioni i furnizimit, 230 V ~ 50 Hz
- është i mundur kombinimi i çelësit me 2 drejtime
- instalimi i disa njësive bashkë në një kuti lejohet vetëm nëse ngarkesa maksimale totale e tyre nuk tejkalon fuqinë maksimale të një reostati të vetëm
- një qark lejon përdorimin e vetëm një reostati
- nuk ka siguresë të integruar - duhet të përdoret siguresa e jashtme
- në përputhje me EN 60669-1
- kontaktet e vidave 1,5-2,5 mm<sup>2</sup>
- treguesi i integruar LED i nivelit të ndriçimit

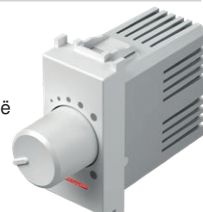

DIMMER ROTATIVE/2WAY RL 300W 1M

- rotation control with 2-way switch
- load RL, 40W - 300W
- supply voltage 230V~ 50Hz
- 2-way switch combination is possible
- installing several devices together in one box is only permitted if their total maximum load does not exceed the maximum power of a single dimmer
- one circuit allows the use of only one dimmer
- no built-in fuse – external fuse must be used
- in accordance with EN 60669-1
- screw contacts - 1.5-2.5mm<sup>2</sup>
- integrated LED indication of dimming level

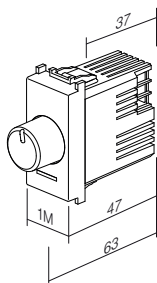



- EM13PW
- EM13MW
- EM13SB
- EM13AT
- EM13ES
- EM13IW

#### REOSTAT RROTULLUES/2 DREJTIME LED 60W 1M

- kontrolli i rrotullimit me çelësin me 2 drejtime
- ngarkesat: LED, 0 – 60W (maks. 6 llamba LED me ulje ndriçimi)  
GLS, 0 – 60 W
- tensioni i furnizimit, 230 V ~ 50 Hz
- është i mundur kombinimi i çelësit me 2 drejtime
- instalimi i disa njësjive bashkë në një kuti lejohet vetëm nëse ngarkesa maksimale totale e tyre nuk tejkalon fuqinë maksimale të një reostati të vetëm
- një qark lejon përdorimin e vetëm një dimeri
- nuk ka siguresë të integruar - duhet të përdoret siguresa e jashtme
- në përputhje me EN-2-1
- kontaktet e vidave 1,5-2,5 mm<sup>2</sup>

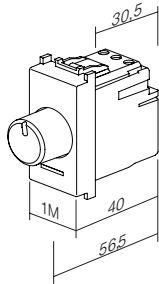

#### DIMMER ROTATIVE/2WAY LED 60W 1M

- rotation control with 2-way switch
- loads: LED, 0 – 60W (max. 6 dimmable LED lamps)  
GLS, 0 – 60W
- supply voltage 230V~ 50Hz
- 2-way switch combination is possible
- installing several devices together in one box is only permitted if their total maximum load does not exceed the maximum power of a single dimmer
- one circuit allows the use of only one dimmer
- no built-in fuse – external fuse must be used
- in accordance with IEC60669-2-1
- screw contacts - 1.5-2.5mm<sup>2</sup>

#### REOSTAT RROTULLUES/2 DREJTIME LED 180W 1M

- EM14PW
- EM14MW
- EM14SB
- EM14AT
- EM14ES
- EM14IW

- kontrolli i rrotullimit me çelësin me 2 drejtime
- ngarkesat:  
LED, 0 – 180 W (maks. 20 llamba LED me ulje ndriçimi)  
GLS, 0 – 180 W
- tensioni i furnizimit, 230 V ~ 50 Hz
- është i mundur kombinimi i çelësit me 2 drejtime
- instalimi i disa njësjive bashkë në një kuti lejohet vetëm nëse ngarkesa maksimale totale e tyre nuk tejkalon fuqinë maksimale të një reostati të vetëm
- një qark lejon përdorimin e vetëm një dimeri
- nuk ka siguresë të integruar - duhet të përdoret siguresa e jashtme
- në përputhje me EN-2-1
- kontaktet e vidave 1,5-2,5 mm<sup>2</sup>

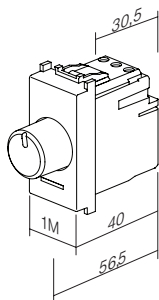
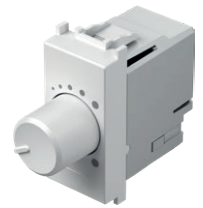

#### DIMMER ROTATIVE/2WAY LED 180W 1M

- rotation control with 2-way switch
- loads:  
LED, 0 – 180W (max. 20 dimmable LED lamps)  
GLS, 0 – 180W
- supply voltage 230V~ 50Hz
- 2-way switch combination is possible
- installing several devices together in one box is only permitted if their total maximum load does not exceed the maximum power of a single dimmer
- one circuit allows the use of only one dimmer
- no built-in fuse – external fuse must be used
- in accordance with IEC60669-2-1
- screw contacts - 1.5-2.5mm<sup>2</sup>

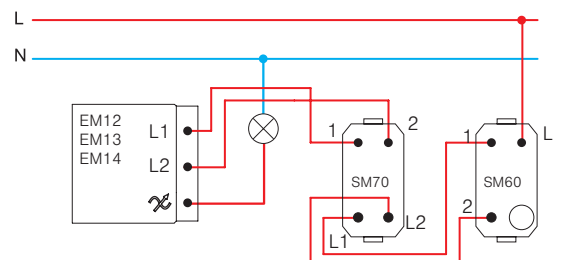
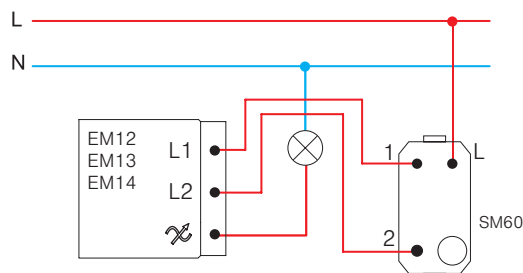
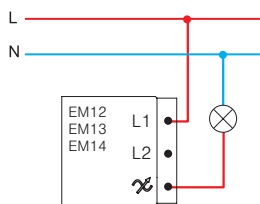



REOSTAT RROTULLUES R 250W 1M



- EM15PW
- EM15MW
- EM15SB
- EM15AT
- EM15ES
- EM15IW

- kontroll rrotullues pa çelës
- ngarkesa R, 40W - 250W
- tensioni i furnizimit, 230 V ~ 50 Hz
- nuk është i mundur kombinimi i çelësit me 2 drejtime
- nuk lejohet kombinim i më shumë reostateve
- në përputhje me EN 60669-1
- kontaktet e vidave 1,5-2,5 mm<sup>2</sup>
- Treguesi LED



*DIMMER ROTATIVE R 250W 1M*

- rotation control without switch
- load R, 40W - 250W
- supply voltage 230V~ 50Hz
- 2-way switch combination is not possible
- more dimmers combination is not allowed
- in accordance with EN 60669-1
- screw contacts 1.5-2.5mm<sup>2</sup>
- LED indication

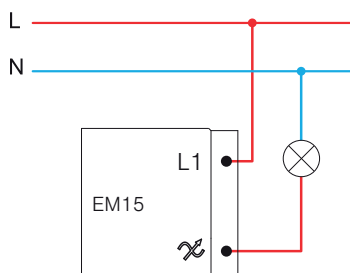
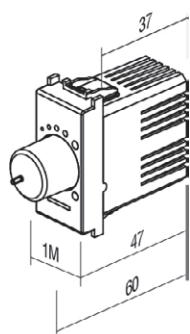

REOSTAT ME MONTIM NË KUTI R (250 W), (RC, RL 200 VA)



EM23



- montim në kuti, me kontroll me buton të jashtëm me shtypje
- RLC me ngarkesë 15-250 W ose 15-200 VA
- tensioni i furnizimit, 230 V ~ 50 Hz
- janë të mundura disa kombinime të butonave me shtypje
- nuk lejohet kombinim i më shumë reostateve
- memorizim i intensitetit të dritës
- funksion ndezje/ndalim i butë
- »leading edge«
- në përputhje me EN60669, EN60950, EN 61000, ETSI EN 300 220-1, ETSI EN 300 220-2
- kontaktet e vidave me tela 2,5 mm<sup>2</sup>

*DIMMER INBOX R (250 W), (RC, RL 200 VA)*

- inbox, controlled by external push button
- load RLC 15-250W or 15-200 VA
- supply voltage 230V~ 50Hz
- several push-buttons combinations are possible
- more dimmers combination is not allowed
- light intensity memory
- soft start/stop function
- »leading edge«
- in accordance with EN60669, EN60950, EN 61000, ETSI EN 300 220-1, ETSI EN 300 220-2
- screw contacts to wires 2,5 mm<sup>2</sup>

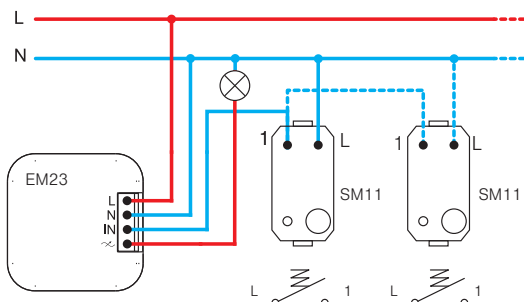
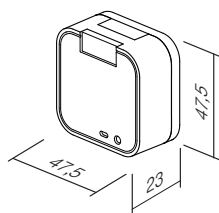



- EM16PW
- EM16MW
- EM16SB
- EM16AT
- EM16ES
- EM16IW



### 1-10 V ÇELËSI RROTULLJUES ME DY DREJTIME I REOSTATIT

- tensioni nominal i punës: 10 V DC
- tensioni minimal i punës: 0,7 VDC
- diapazoni i errësimit: 0,7 - 100%
- (në varësi të furnizimit me energji dhe të ngarkesës)
- rënia minimale e rrymës: 0,1 mA
- rënia maksimale e rrymës: 120 mA
- konsumi maksimal: 0,35 W
- mbrojtja nga mbitensioni: 15,8 V DC deri në 250 mA (jo e zëvendësueshme)
- rryma maksimale e impulsit: 3 A DC
- lloji i ngarkesës: 0-10 V, 1-10 V dhe PWM
- lloji i çelësit: mekanik: me shtypje për ndezje/fikje
- kabllo nul: nuk nevojitet
- tensioni nominal i funksionimit: 100-240 V~, 50-60 Hz
- rryma maksimale e menjëhershme: 10 A
- rryma maksimale e punës: 8 A
- ngarkesa maksimale (në 230 V~): 1800 VA (1800 x pf = maksimumi W)
- rezistenca e izolimit: > 100 MΩ në 250 V~
- mbrojtja nga mbitensionet dhe mbrojtja nga qarku i shkurtër: 10 A, 350 V~ (jo e zëvendësueshme)
- këndi i rrotullimit: 270° ± 5°
- temperatura e punës: -5 deri në 40°C
- temperatura e ruajtjes: -30 deri në 80°C
- temperatura maksimale e strehimit: 65°C
- lagështia maksimale: 90% (pa kondensim)
- EMC dhe imuniteti: CISPR 15 (2008), IEC 61547
- LVD: IEC 60669-1: 2017, IEC 60669-2-1: 2015

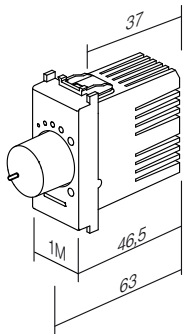

### 1-10 V DIMMER ROTARY TOGGLE

- nominal operating voltage: 10 VDC
- minimum operating voltage: 0.7 VDC
- dimming range: 0.7% - 100% (depending on power supply and loads)
- minimum sink current: 0.1 mA
- maximum sink current: 120 mA
- maximum consumption: 0.35 W
- surge protection: 15.8 VDC up to 250 mA (not replaceable)
- maximum pulse current: 3 ADC
- load types: 0-10 V, 1-10 V and PWM
- switch type: mechanical: push on/off
- zero cable: not required
- nominal operating voltage: 100-240 V~, 50-60 Hz
- maximum instantaneous current: 10 A
- maximum operating current: 8 A
- maximum load (at 230 V~): 1800 VA (1800 x pf = max. W)
- isolation resistance: > 100 MΩ at 250 V~
- surge protection and Short-circuit protection: 10 A, 350 V~ (not replaceable)
- rotation angle: 270° ± 5°
- operating temperature: -5 to 40°C
- storing temperature: -30 to 80°C
- maximum housing temperature: 65°C
- maximum humidity: 90% (no condensation)
- EMC & immunity: CISPR 15(2008), IEC 61547
- LVD: IEC 60669-1:2017, IEC 60669-2-1:2015

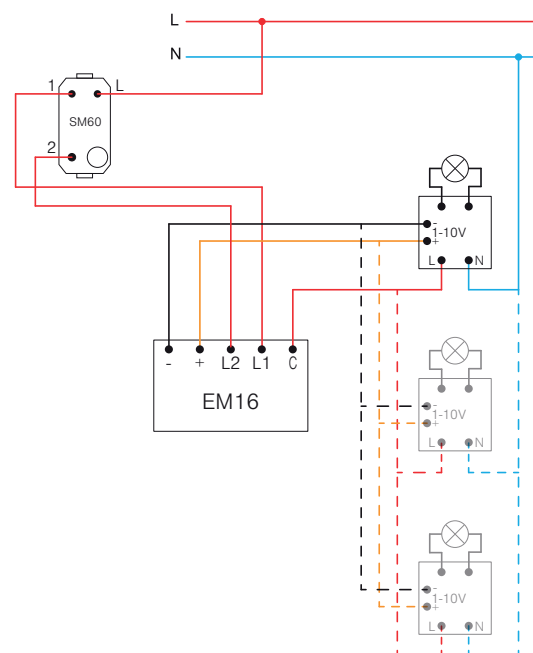
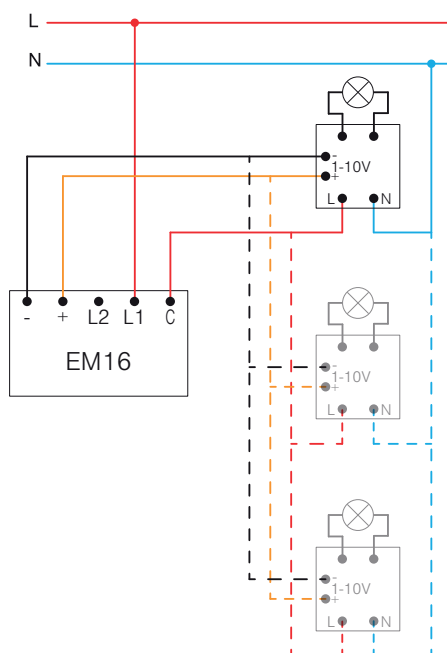



Moduli I KONTROLLIT MZC për EM18

EM17

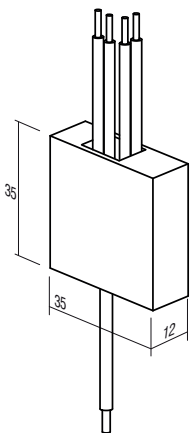

- Lidh MZC sipas diagramit të instalimit elektrik.
- Instalim i mundshëm elektrik me disa butona.
- Vetëm një instalim pajisjeje për kuti montimi.
- Vetëm për përdorim të brendshëm.
- Furnizimi i energjisë: 230 V~ 50 Hz
- Rezistenca maksimale e kablos: 50 kΩ
- Rryma maksimale për njësi MZC: 10 mA
- Numri i pajisjeve të ndriçimit në MZC: 1-4
- Numri maksimal i MZC në instalimin elektrik: i kufizuar me siguresën e shkri shme në qark
- Temperatura e funksionimit: -5°C deri në 45°C
- Temperatura e ruajtjes: -30°C deri në 80°C
- Lagështia maksimale: 90% (pa kondensim)
- Përmasat e kasës: 36x36x12 mm

MZC CONTROL Module for EM18

- Connect the MZC according to the wiring diagram.
- Possible wiring with several push buttons.
- Only one device installation per mounting box.
- For indoor use only.
- Power supply: 230V~ 50Hz
- Max. cable resistance: 50kΩ
- Max. current per MZC unit: 10mA
- Number of dimmers on MZC: 1-4
- Max. number of MZC in the wiring: limited to the fuse in the circuit
- Operating temperature: -5°C to 45°C
- Storage temperature: -30°C to 80°C
- Max. humidity: 90% (no condensation)
- Casing dimensions: 36x36x12 mm

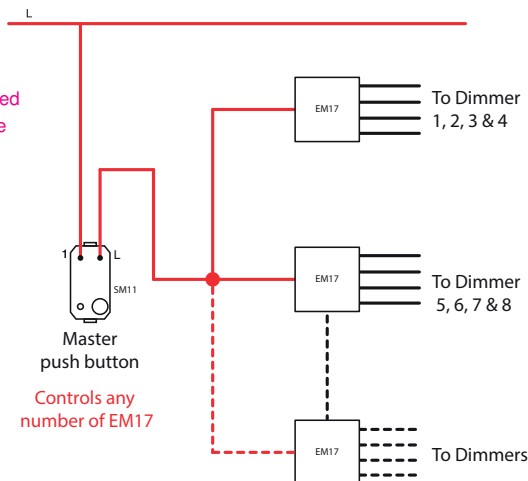
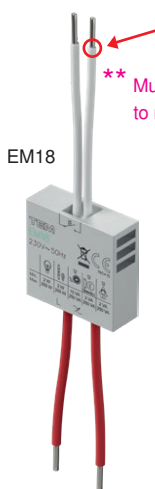
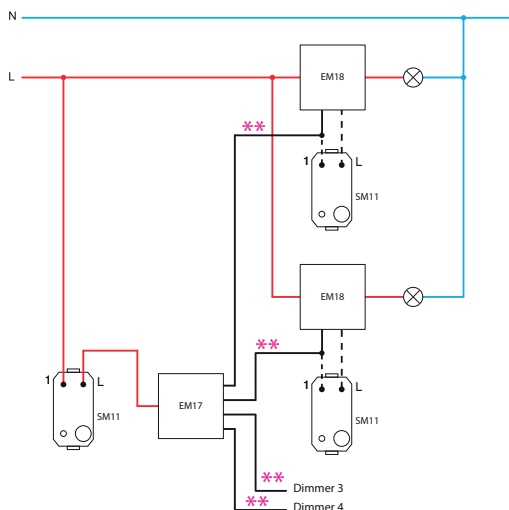

REOSTAT ME MONTIM NË KUTI LED 250 W

EM18

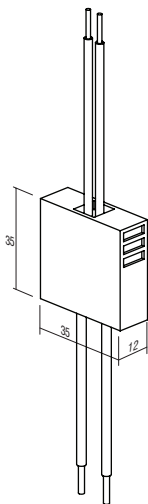

- montim në kuti, me kontroll me buton të jashtëm me shtypje
- për anën e përparme ose fundore
- tensioni i furnizimit, 230 V ~ 50 Hz
- janë të mundura disa kombinime të butonave me shtypje
- funksioni i memories së cilësimit të fundit, me përjashtim të rastit të ndërprerjes së energjisë
- funksioni i ndezjes/ndalimit të butë
- kontrolli i intensitetit minimal
- vetëm një reostat për kuti muri
- vetëm për përdorim të brendshëm
- në përputhje me standardet EN 60669-1 dhe EN 60669-2-1



DIMMER INBOX LED 250W

- inbox, controlled by external push button
- for leading or trailing edge
- supply voltage 230V~ 50Hz
- several push-buttons combinations is possible
- memory function of the last setting, except in the case of a power failure
- soft start / stop function
- minimum intensity control
- only one dimmer per wall box
- only for indoor usage
- in accordance with EN 60669-1 and EN 60669-2-1

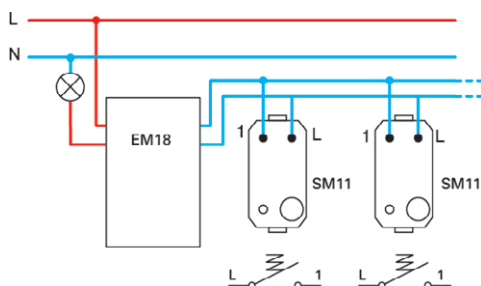

REOSTAT ME MONTIM NË KUTI DC LED 96 W

EM19

- montim në kuti, me kontroll me buton të jashtëm me shtypje
- për përdorim me drajverë për LED me tension konstant dhe disa drajverë për LED me rrymë konstante, 9-48 V DC, maks. 96 W (edhe për shiritat LED)
- jo për përdorim me ngarkesa me induksion
- janë të mundura kombinime të disa butonave me shtypje dhe disa reostateve
- funksioni i memories së cilësimit të fundit, me përjashtim të rastit të ndërprerjes së energjisë
- funksioni i ndezjes/ndalimit të butë
- vetëm një reostat për kuti muri
- vetëm për përdorim të brendshëm

DIMMER INBOX DC LED 96W

- inbox, controlled by external push button
- for use with constant voltage LED drivers and some constant current LED drivers, 9-48V DC, max 96W (also for LED strips)
- not for use with inductive loads
- several push-buttons combinations and several dimmers is possible
- memory function of the last setting, except in the case of a power failure
- soft start / stop function
- only one dimmer per wall box
- only for indoor usage

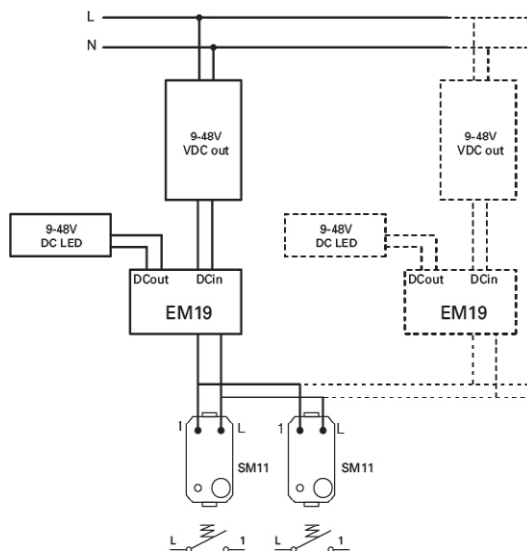
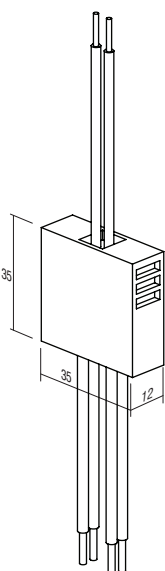

**KUJDES!**

Nëse lidhen më shumë reostatë në një kuti, reduktoni fuqinë e përbashkët me 10% për secilin reostat.

**ATTENTION!**

If more dimmers are connected in one box reduce maximum common power for 10% for each dimmer.

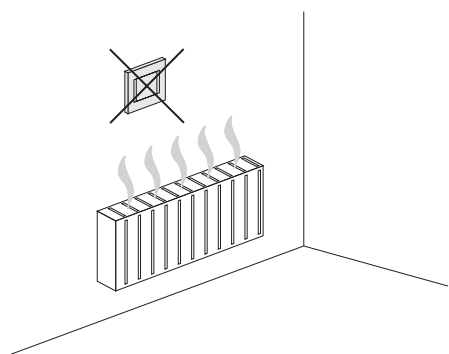

EM15 (40÷250W)

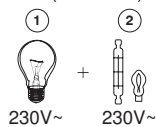

EM12 (40÷300W)

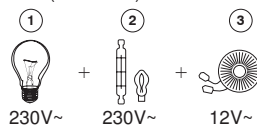

EM13 (0÷60W), EM14 (0÷180W), EM23 (15÷250W, 15÷200VA),

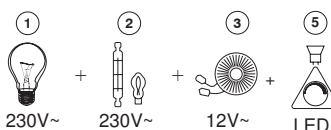

EM18 (2÷250VA)

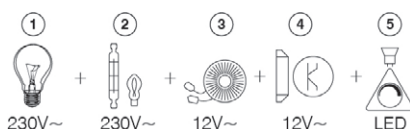

- 1 - llambë inkandeshente / incandescent lamp
- 2 - llambë halogjene / halogen lamp
- 3 - transformator klasik / classical transformer
- 4 - transformator elektrik me dimer / dimmable electronic transformer
- 5 - llambë LED me ulje ndriçimi / dimmable LED lamp



ÇELËS / REOSTAT UNIVERSAL RLC 0-300W 2M

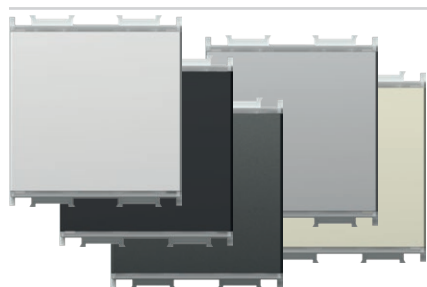

- EM25PW
- EM25MW
- EM25SB
- EM25AT
- EM25ES
- EM25IW

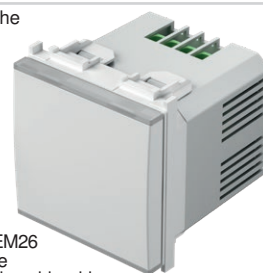

TOUCH EM25 është një reostat elektronik ndriçimi i kontrolluar me mikroprocesor. Ai shërben si çelës dhe reostat për llambat me ulje ndriçimi dhe disa llamba pa ulje ndriçimi. Mikroprocesori i integruar identifikon automatikisht llojin e llambës dhe rregullon regjimin e funksionimit. Ai memorizon nivelin e uljes së ndriçimit pas fikjes falë funksionit të integruar të memorizimit. Funksioni i ndezjes së butë zgjat jetëgjatësinë e llambës. Një tregues elegant LED është integruar në buton dhe ofrohet opsioni i zgjedhjes së ngjyrës dhe nivelit të intensitetit. Ndonjëherë mund të lidheni me deri në 5 çelësa kontrolli shtesë EM26 ("slave") në EM 25.

TOUCH EM25 is microprocessor controlled electronic light dimmer. It serves as switch and dimmer for dimmable and some of non-dimmable lamps. Integrated microprocessor automatically identifies the type of lamp and adjusts the operating mode. It remembers the level of dimming after switching off due to integrated memory function. Soft-start function extends the lamp service life. An elegant LED indication is integrated into the button and the option of choosing a colour and intensity level is provided. Optionally one can connect of up to 5 additional control tasters EM26 (»slave«).

- reostat universal elektronik për NDEZJE/FIKJE dhe ulje ndriçimi të të gjitha llambave me ulje ndriçimi (klasike, halogjene, LED, CFL, ...) dhe disa llambave pa ulje ndriçimi
- zbulim automatik i llojit të llambës dhe rregullimit të regjimit të funksionimit
- reduktim i konsumit të energjisë
- funksioni i ndezjes së butë zgjat jetëgjatësinë e llambave
- kontrolluar me mikro çelësa të integruar
- funksioni i memorizimit i përfshirë – memorizon ndriçimin në ndezje
- mund të lidhen deri në pesë (5) njësi kontrolli shtesë EM26
- nuk është e mundur lidhja me çelës me 2 drejtime
- qark i shkurtër i integruar, mbrojtje nga mbingarkesa dhe mbinxehja
- tensioni i furnizimit, 230 V ~ 50 Hz
- një tregues elegant LED i integruar me opsionin e caktimit të ngjyrave dhe intensitetit.
- është i mundur zëvendësimi i çelësit klasik në lidhjen me dy tela (1)
- funksionimi i plotë arrihet në lidhjen me tre tela (2)
- në përputhje me standardet EN 60669-1 dhe EN 60669-2-1
- kontaktet e vidave 1,5mm<sup>2</sup> (forca maks. e shtrëngimit 0,4 Nm)

SWITCH / DIMMER UNIVERSAL RLC 0-300W 2M

- universal electronic dimmer for ON/OFF switching and dimming of all dimmable lamps (classical, halogen, LED, CFL, ...) and some non-dimmable lamps
- automatic detection of lamp type and adjustment of operating mode
- reduction of energy consumption
- soft start function extends life of lamps
- controlled by build-in micro switches
- memory function included – memorizes brightness on turn-off
- up to five (5) additional control units EM26 can be connected
- connection with 2-way switch is not possible
- build-in short-circuit, overheating and overload protection
- supply voltage 230V~ 50Hz
- an elegant integrated LED indication with the option of setting colour and intensity.
- replacement of classical switch is possible at two-wire connection<sup>(1)</sup>
- full functionality is achieved at three-wire connection<sup>(2)</sup>
- in accordance with EN 60669-1 and EN 60669-2-1
- screw contacts 1.5mm<sup>2</sup> (max. tightening torque 0.4Nm)

(1)lidhje me dy tela  
two-wire connection

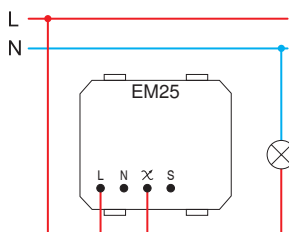

(2)lidhje me tre tela  
three-wire connection

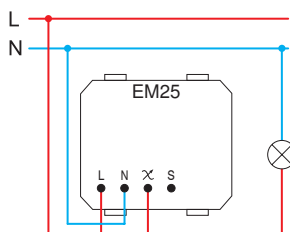

- lidhja me dy tela lejon uljen e ndriçimit të llambave me ulje ndriçimi
- two-wire connection allows dimming of dimmable lamps

- lidhja me tre tela lejon uljen e ndriçimit të llambave me ulje ndriçimi dhe disa pa ulje ndriçimi dhe llambave CFL
- three-wire connection allows dimming of dimmable lamps and some of non-dimmable LED and CFL lamps

	1	2	5	6	7
Min.	40 W	40 W	40 VA	40 VA	40 VA
Max.	300 W	300 W	300 VA	100 VA	100 VA
	(F)	(F)	(F)		

	1	2	4	6	7	8	9
Min.	0 W	0 W	0 VA	0 VA	0 VA	0 VA	0 VA
Max.	300 W	300 W	120 VA	120 VA	120 VA	120 VA	120 VA
	(F)	(F)	(F)			(F)	(F)

- 1 - llambë inkandeshente / incandescent lamp
- 2 - llambë halogjene / halogen lamp
- 4 - transformator elektrik me dimer / dimmable electronic transformer
- 5 - transformator klasik / classical transformer

- 6 - llambë CFL me ulje ndriçimi me kursim energjie / dimmable energy saving CFL lamp
- 7 - llambë LED me ulje ndriçimi / dimmable LED lamp
- 8 - llambë CFL pa ulje ndriçimi me kursim energjie / non-dimmable energy saving CFL lamp
- 9 - llambë LED pa ulje ndriçimi / non-dimmable LED lamp

shënime / remarks

- (F) filter EM27  
- rekomandohet të përdoret filtri EM27 / it is recommended to use filter EM27
- të gjitha llambat e kontrolluara duhet të jenë të njëjta / all controlled lamps must be the same
- tabela e ngarkesave është e vlefshme për llambat me faktor fuqie PF>0.5 / table of loads is valid for lamps with power factor PF>0.5

ndezje/fikje dhe ulje e ndriçimit të llambës /  
on / off swithcing and dimming of lamp

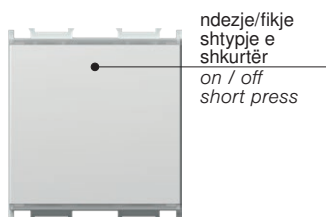

ndezje/fikje  
shtypje e  
shkurtër  
on / off  
short press

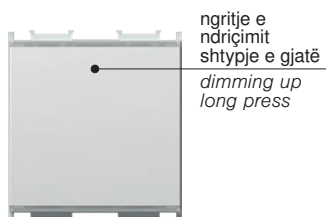

ngritje e  
ndriçimit  
shtypje e gjatë  
dimming up  
long press

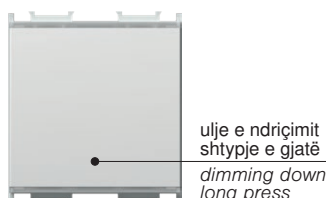

ulje e ndriçimit  
shtypje e gjatë  
dimming down  
long press

Ngjyra e njësisë LED dhe zgjedhja e nivelit të intensitetit /  
LED unit colour and intensity level selection

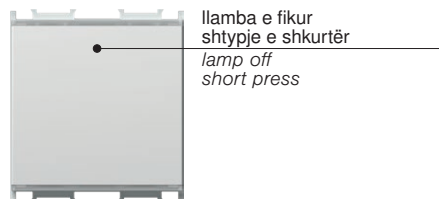

llamba e fikur  
shtypje e shkurtër  
lamp off  
short press

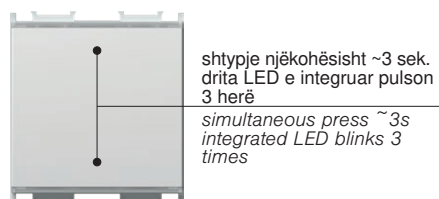

shtypje njëkohësisht ~3 sek.  
drita LED e integruar pulson  
3 herë  
simultaneous press ~3s  
integrated LED blinks 3  
times



përzgjedhje e ngjyrave  
shtypje e shkurtër  
colour selection  
short press

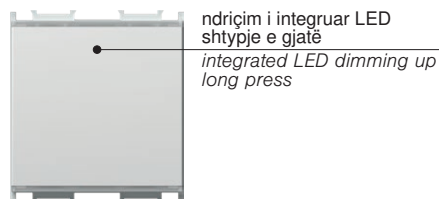

ndriçim i integruar LED  
shtypje e gjatë  
integrated LED dimming up  
long press

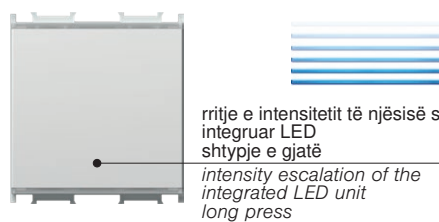

rritje e intensitetit të njësisë së  
integruar LED  
shtypje e gjatë  
intensity escalation of the  
integrated LED unit  
long press

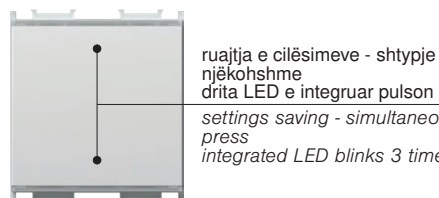

ruajtja e cilësimeve - shtypje e shkurtër e  
njëkohshme  
drita LED e integruar pulson 3 herë  
settings saving - simultaneous short  
press  
integrated LED blinks 3 times

funksion "RESET"/  
"RESET" function

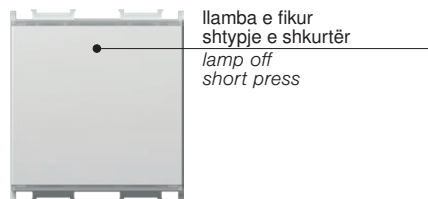

llamba e fikur  
shtypje e shkurtër  
lamp off  
short press

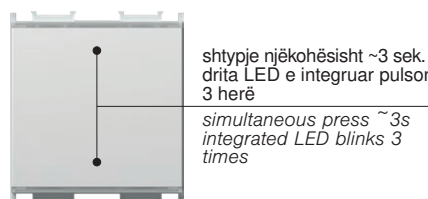

shtypje njëkohësisht ~3 sek.  
drita LED e integruar pulson  
3 herë  
simultaneous press ~3s  
integrated LED blinks 3  
times

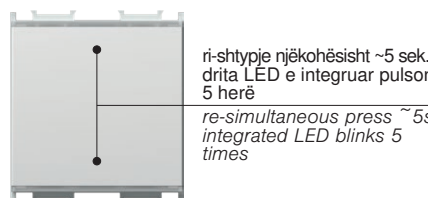

ri-shtypje njëkohësisht ~5 sek.  
drita LED e integruar pulson  
5 herë  
re-simultaneous press ~5s  
integrated LED blinks 5  
times

- \* - rekomandohet në instalimin e reostatit dhe ndërrimin e llambës
- e detyrueshme kur përdoren llamba pa ulje ndriçimi
- funksioni "RESET" nuk është i mundur kur përdoret lidhje me dy tela
- i mundur vetëm në EM25
- it is recommended at dimmer installation and lamp replacement
- mandatory when using non-dimmable lamps
- "RESET" function is not possible when using two-wire connection
- only possible on EM25

masat paraprake të instalimit /  
installation precautions

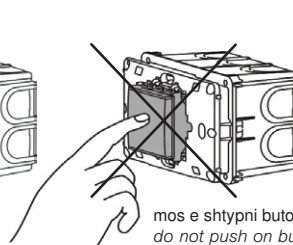
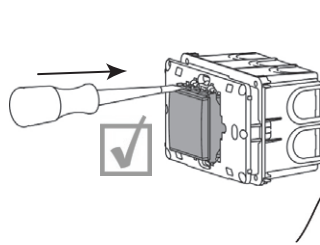
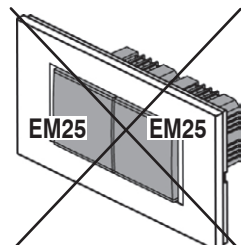
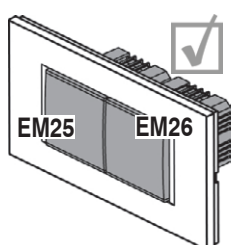

mos e shtypni butonin gjatë montimit /  
do not push on button during mounting

### NJËSI KONTROLLI ME BUTON ME SHTYPJE 2M

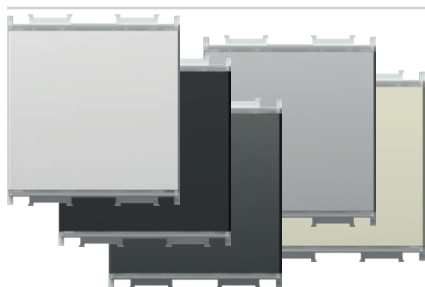

- EM26PW
- EM26MW
- EM26SB
- EM26AT
- EM26ES
- EM26IW

- e lidhur me reostatin universal EM25 lejon kontrollimin e llambave me të njëjtin funksionim (deri) si EM25
- tensioni i furnizimit, 230 V ~ 50 Hz
- në përputhje me standardet EN 60669-1 dhe EN 60669-2-1
- kontaktet e vidave 1,5 mm<sup>2</sup> (maks. e shtrëngimit 0,4 Nm)



#### PUSH-BUTTON CONTROL UNIT 2M

- connected to universal dimmer EM25 allows controlling of lamps with same functionality as EM25
- supply voltage 230V~ 50Hz
- in accordance with EN 60669-1 and EN 60669-2-1
- screw contacts 1.5mm<sup>2</sup> (max. tightening torque 0.4Nm)

(1) lidhje me dy tela  
two-wire connection

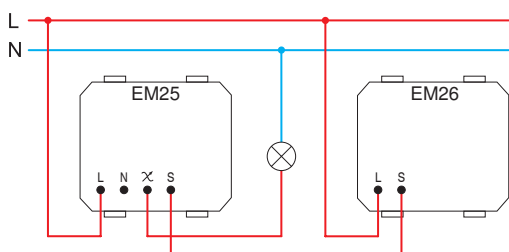

- lidhja me dy tela lejon uljen e ndriçimit të llambave me ulje ndriçimi
- në një lidhje me dy tela secila njësi shtesë kontrolli rrit ngarkesën minimale me 25 W

- two-wire connection allows dimming of dimmable lamps
- in a two-wire connection each additional control unit increases the minimum load by 25W

(2) lidhje me tre tela  
three-wire connection

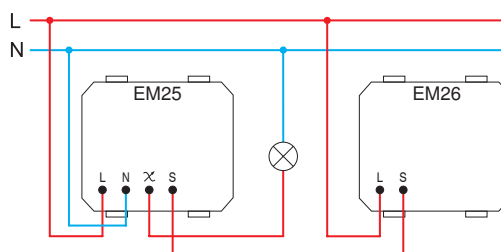

- lidhja me tre tela lejon uljen e ndriçimit të llambave me ulje ndriçimi dhe disa pa ulje ndriçimi dhe llambave CFL

- three-wire connection allows dimming of dimmable lamps and some of non-dimmable LED and CFL lamps

### SET ÇELËS / REOSTAT UNIVERSAL RLC 0-300W 2M PP OL20

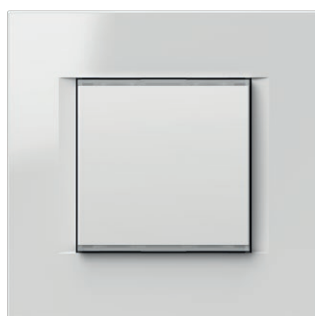

- EM25PPOL20

- seti përfshin reostatin EM25, kornizën e montimit 2M dhe kapakun mbulues LINE 2M PW
- për detaje teknike shikoni EM25

#### SET SWITCH / DIMMER UNIVERSAL RLC 0-300W 2M PP OL20

- set includes dimmer EM25, mounting frame 2M and cover plate LINE 2M PW
- for technical details see EM25



2M = 45 x 45

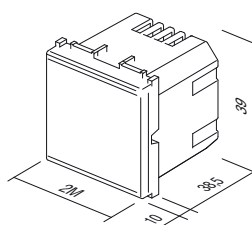

EM25  
EM26





EM27

**FILTRI I FREKUENCËS**

- filtri i frekuencës për EM25
- imazhi është simbolik

**FREQUENCY FILTER**

- frequency filter for EM25
- image is symbolic

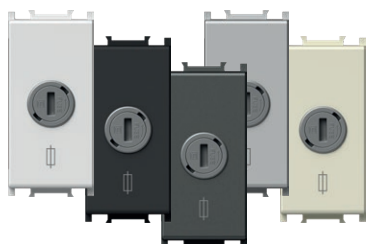
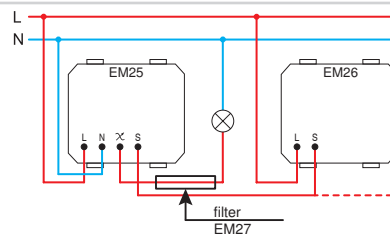

- EM28PW
- EM28MW
- EM28SB
- EM28AT
- EM28ES
- EM28IW

**FOLE PËR SIGURESË TË SHKRIRË 230 V~, 50 Hz 1M**

- Tensioni i furnizimit: 230 V~, 50 Hz
- Siguresa: MAX 10 A / 230 V~, 50Hz
- Prerje e tërthortë e telit: 0,75 - 2,5 mm<sup>2</sup>
- Temperatura e funksionimit: 0 deri +40°C
- Temperatura e ruajtjes: -5 deri +60°C
- Numri i konektorëve: 2; 1x L, 1x Dalja (L')
- I korrespondon standardit: EN 60669-2-1:2004 + A1:2009 + A12:2010 EN 60669-1:2018



**MELT FUSE HOUSING 230 V~, 50 Hz 1M**

- Supply voltage: 230 V~, 50 Hz (fuse not included)
- Fuse: MAX 10 A / 230 V~, 50Hz
- Wire cross-section: 0.75 - 2.5mm<sup>2</sup>
- Operating temperature: 0 to +40°C
- Storage temperature: -5 to +60°C
- Number of connectors: 2; 1x L, 1x Output (L')
- Corresponds to the standard: EN 60669-2-1:2004 + A1:2009 + A12:2010 EN 60669-1:2018



EM29

**SIGURESË**

- T5AH 250V, 5x20mm
- ambalazhuar në pako me 10 copë

**FUSE T5AH**

- T5AH 250V, 5x20mm
- packed in packs of 10 pcs



- EM31PW
- EM31MW
- EM31SB
- EM31AT
- EM31ES
- EM31IW

**ÇELËS IR 5A 230V~ 1M**

- çelës IR me infra të kuqe
- tensioni i furnizimit: 230 V~ ±10 % 50 Hz
- rele: 5 A / 250 V~ (zero kryqëzim)
- vlerësimi i mbrojtjes: IP40
- preja e tërthortë e telave në kontakt 0,75 - 2,5 mm<sup>2</sup>
- zona e zbulimit: deri në 110° në 20°C
- zona e zbulimit: rreth 8 m në 20°C
- rregullimi i kohëzgjatjes: nga rreth 5 sek. në 12 min.
- rregullimi i ndriçimit: nga rreth 5 deri 200 LUX
- temperatura e funksionimit: nga 0°C në +40°C
- i papërshtatshëm për instalim në kuti me thellësi 45 mm dhe kuti montimi në sipërfaqe CUBO IP20
- vetëm për përdorim të brendshëm



**IR SWITCH 5A 230V~ 1M**

- IR infrared switch
- supply voltage: 230V~, ±10 % 50Hz
- relay: 5 A / 250V~, (zero crossing)
- protection rating: IP40
- cross-section of wires at the contact terminal: 0.75 - 2.5 mm<sup>2</sup>
- detection angle: up to 110° at 20°C
- detection area: approx. 8 m at 20°C
- adjustability of duration: from approx. 5 s to 12 min
- adjustability of brightness: from approx. 5 to 200 LUX
- operating temperature: from 0°C to +40°C
- not suitable for installation in 45 mm deep boxes and surface mount box CUBO IP20
- only for indoor usage

### ÇELËS IR 5 A 230 V~ 2M

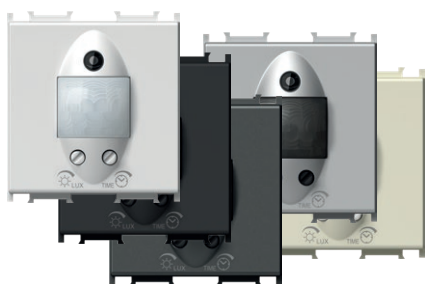

- EM32PW
- EM32MW
- EM32SB
- EM32AT
- EM32ES
- EM32IW



- çelës IR me infra të kuqe
- tensioni i furnizimit: 230 V~ ±10 % 50 Hz
- rele: 5 A / 250 V~ (zero kryqëzim)
- vlerësimi i mbrojtjes: IP40
- prerja e tërthortë e telave në kontakt 0,75 - 2,5 mm<sup>2</sup>
- zona e zbulimit: deri në 110° në 20°C
- zona e zbulimit: rreth 8 m në 20°C
- rregullimi i kohëzgjatjes: nga rreth 5 sek. në 12 min
- rregullimi i ndriçimit: nga rreth 5 deri 200 LUX
- temperatura e funksionimit: nga 0°C në +40°C
- i papërshatshëm për instalim në kuti me thellësi 45 mm dhe kuti montimi në sipërfaqe CUBO IP20
- vetëm për përdorim të brendshëm



### IR SWITCH 5A 230V~ 2M

- IR infrared switch
- supply voltage: 230V~, ±10 % 50Hz
- relay: 5A / 250V~, (zero crossing)
- protection rating: IP40
- cross-section of wires at the contact terminal: 0.75 - 2.5 mm<sup>2</sup>
- detection angle: up to 110° at 20°C
- detection area: approx. 8 m at 20°C
- adjustability of duration: from approx. 5 s to 12 min
- adjustability of brightness: from approx. 5 to 200 LUX
- operating temperature: from 0°C to +40°C
- not suitable for installation in 45 mm deep boxes and surface mount box CUBO IP20
- only for indoor usage



### ÇELËS ME SENSOR 5A 230V~ 1M



- EM33PW
- EM33MW
- EM33SB
- EM33AT
- EM33ES
- EM33IW



- Tensioni i furnizimit: 230 V~, 50 Hz
- Dalja: Rele 5 A/230 V~, 50 Hz
- Prerje e tërthortë e telit: 0,75 - 2,5 mm<sup>2</sup>
- Temperatura e funksionimit: 0 deri +40°C
- Temperatura e ruajtjes: -5 deri +60°C
- Funksionet: Çelës nate, Çelës me zbulim të lëvizjes, Çelës me zbulim të pranisë
- Treguesi i programit: Shenja në kapakun e përpamë
- Numri i tasteve/kontrolleve: 3
- Lloji i funksionimit të tastit/kontrollit: Rrotullimi
- Rregullimi i kohës së aktivizimit të daljes: Nga rreth 10 sek. në 12 minuta
- Zona e zbulimit: Rreth 8 m
- Këndi i zbulimit: Deri në 110°
- Rregullimi i ndriçimit: Nga ~5 në ~200 lux
- Numri i konektorëve: 4: 1x N, 1x L, 1x dalje (L'), 1x hyrje e kontrolluar (S)
- Opsioni i hyrjes së kontrolluar: Po. Lidhja e sinjalit kryesor të tensionit (230 V~) me terminalin S.
- Opsionale: »Zero kryqëzim« (takim-stakimi i çelësit kur tensioni kalon përmes 0 V)
- Konsumi i energjisë në gjendjen FIKUR / NDEZUR I korrespondon standardit: 0.3 W / 0.6 W EN 60669-2-1:2004 + A1:2009 + A12:2010 EN 60669-1:2018



### SENSOR SWITCH 5A 230V~ 1M

- Supply voltage: 230 V~, 50Hz
- Output: Relay 5 A / 230 V~, 50 Hz
- Wire cross section: 0.75 - 2.5 mm<sup>2</sup>
- Operating temperature: 0 to + 40 °C
- Storage temperature: -5 to + 60 °C
- Functions: Night switch, Motion detection switch, Presence Detection Switch
- Programme indication: Mark on front cover
- Number of keys/controls: 3
- Operation Type of Key/Control: Rotation
- Adjusting the output activation time: From approx. 10 sec to 12 minutes
- Detection Area: Approximately 8 m
- Detection angle: Up to 110°
- Illumination adjustment: From ~5 to ~200 lux
- Number of connectors: 4: 1x N, 1x L, 1x Output (L'), 1x Controlled input (S)
- Controlled input option: Yes. Connection of the main voltage signal (230 V~) to terminal S.
- Optional: "Zero Crossing" (switching the switch when the voltage passes through 0 V)
- Power consumption in the OFF/ON state Corresponds to the standard: 0.3 W / 0.6 W EN 60669-2-1:2004 + A1:2009 + A12:2010 EN 60669-1:2018

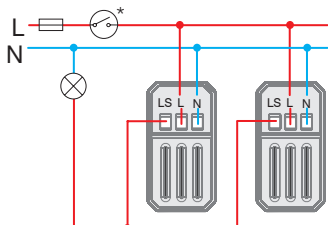

EM31 / EM32

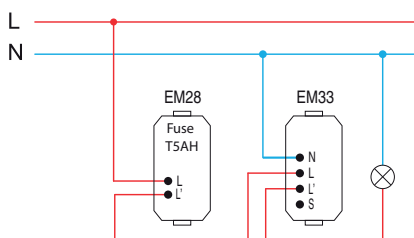

EM33

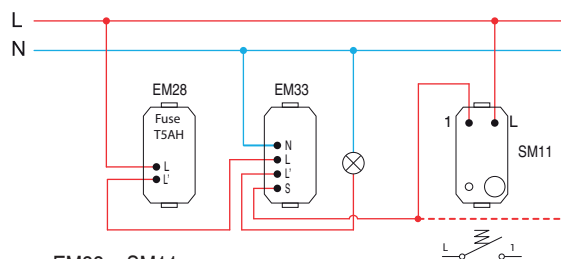

EM33 + SM11

EM31 / EM32

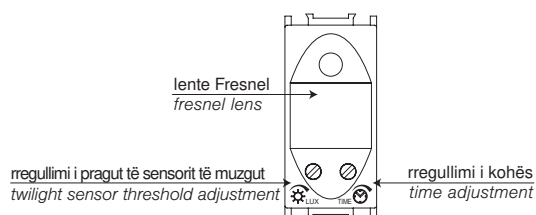

EM33

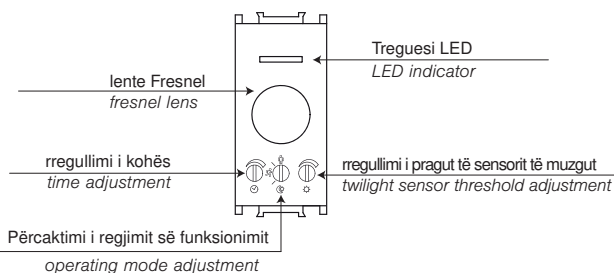

koha dhe rregullimi për muzgun /  
time and twilight adjustment

		EM31 / EM32	EM33	EM31 / EM32	EM33
		~ 5 LUX	~ 5 LUX	~ 200 LUX	~ 200 LUX
		~ 5 s	~10 s	~12 min	~12 min

Regjimet e funksionimit EM33  
EM33 operating mode

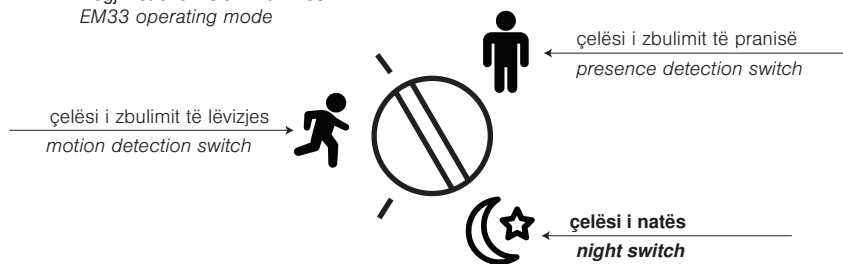

llojet e ngarkesave  
types of load

		1	2	3	4	5	6	7	8	9	10
EM31 EM32 EM33	min.	1 W	1 W	—	1 VA	—	— cos fi=0.6	1 W1	W	1 VA	1 VA
EM31 EM32	max.	800 W	800 W	5 A	6x20 VA	—	—	6x36 W	4x36 W	6x23 VA	6x20 VA
EM33	max.	5 A	1000 W	5 A	650 VA	650 VA	2 A	—	—	100 VA	100 VA

1 - llambë inkandeshte /  
incandescent lamp

3 - element ngrohjeje me rezistencë /  
resistive heating element

5 - transformator klasik /  
classical transformer

7 - llambë neoni fluoreshente (versioni 1) /  
fluorescent tube (version 1)

2 - llambë halogjene /  
halogen lamp

4 - transformator elektrik /  
electronic transformer

6 - motori /  
motor

8 - llambë neoni fluoreshente (versioni 2) /  
fluorescent tube (version 2)

9 - llambë CLF me kursim energjie /  
energy saving CFL lamp

10 - llambë LED /  
LED lamp

gama e zbulimit /  
detection range

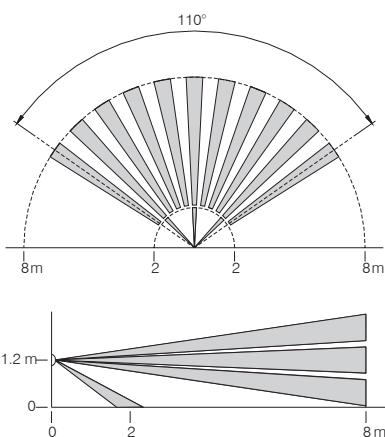

kujdes /  
attention

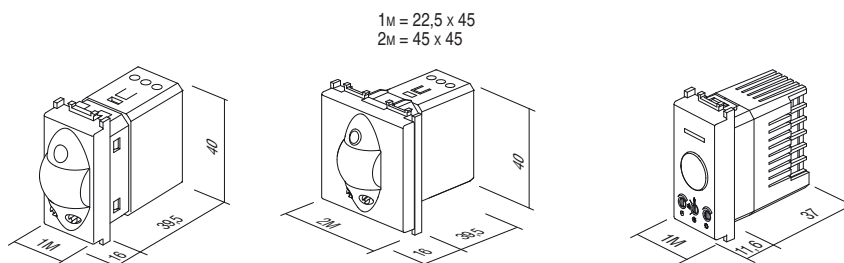
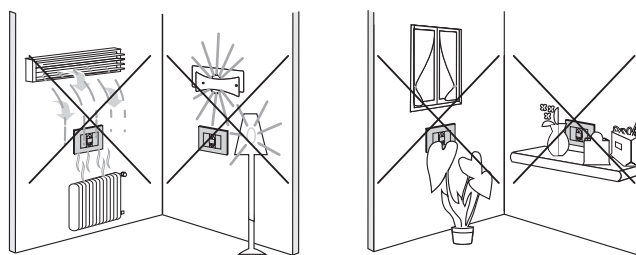



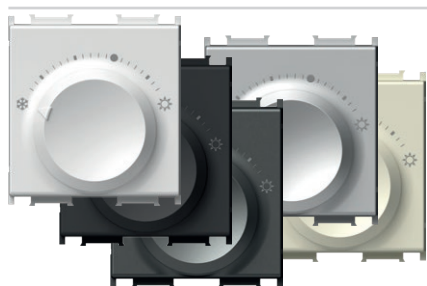

- EM38PW
- EM38MW
- EM38SB
- EM38AT
- EM38ES
- EM38IW

**TERMOSTATI I NGROHJES 5(2)A 230V~ 2M**

- mënyra e funksionimit: ftohje
- furnizimi me energji elektrike: 230 V~, 50 Hz
- impulsi i tensionit: 4 kV
- konsumi i energjisë: < 0,5 W
- prodhimi: 2 A (maksimumi 5 A); 230 V~, 50 Hz
- dalja e ndërrimit: NO (maksimumi 10 aktivizues)
- gama e rregullimit: +5°C deri +30°C
- mbrojtja nga ngricat: +5°C
- histereza: 0,5 K
- mbrojtja: IP30
- lloji i sensorit: Bimetal
- lloji i lidhjes elektrike: kontakte me susta
- lloji i përcjellësve: 0,75 - 1,5 mm<sup>2</sup> (bërthama fleksibël me fije); 1,0 - 2,5 mm<sup>2</sup> (bërthama e fortë)
- në përputhje me direktivën DIN EN 60730



**HEATING THERMOSTAT 5(2)A 230V~ 2M**

- operation mode: heating
- power supply: 230 V~, 50 Hz
- voltage pulse: 4 kV
- energy consumption: < 0.5 W
- output: 2 A (max. 5 A); 230 V~, 50 Hz
- switching output: NO (max. 10 actuators)
- regulation range: +5°C to +30°C
- frost protection: +5°C
- hysteresis: 0.5 K
- protection: IP30
- sensor type: Bimetal
- type of electrical connection: Spring-loaded contacts
- type of conductors: 0.75 - 1.5 mm<sup>2</sup> (flexible-stranded core); 1.0 - 2.5 mm<sup>2</sup> (solid core)
- in compliance with Directive DIN EN 60730

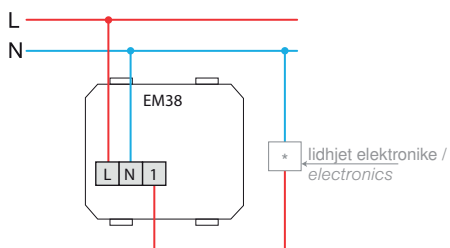

TERMOSTAT NGROHJEJE/FTOHJEJE 3(1,5)A 230V~ 2M

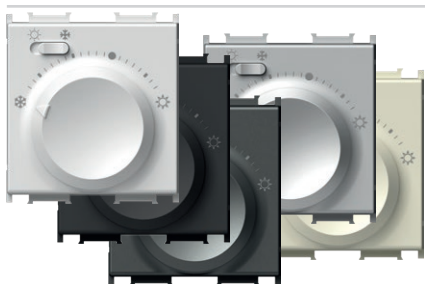

- EM39PW
- EM39MW
- EM39SB
- EM39AT
- EM39ES
- EM39IW

- mënyra e funksionimit: ftohje/ngrohje
- furnizimi me energji elektrike: 230 V~, 50 Hz
- impulsi i tensionit: 4 kV
- konsumi i energjisë: < 0,5 W
- prodhimi: 1.5 A (maksimumi 3 A); 230 V~, 50 Hz
- dalja e ndërrimit: çelësi i zgjedhjes së modalitetit (maksimumi 5 aktivizues)
- gama e rregullimit: +5°C deri +30°C
- mbrojtja nga ngricat: +5°C
- histereza: 0,5 K
- mbrojtja: IP30
- lloji i sensorit: Bimetal
- lloji i lidhjes elektrike: kontakte me susta
- lloji i përcjellësve: 0,75 - 1,5 mm<sup>2</sup> (bërthama fleksibël me fije); 1,0 - 2,5 mm<sup>2</sup> (bërthama e fortë)
- në përputhje me direktivën DIN EN 60730



HEATING/COOLING THERMOSTAT 3(1.5)A 230V~ 2M

- operation mode: cooling/heating
- power supply: 230 V~, 50 Hz
- voltage pulse: 4 kV
- energy consumption: < 0.5 W
- output: 1 A (max. 3 A); 230 V~, 50 Hz
- switching output: mode selector switch (max. 5 actuators)
- regulation range: +5°C to +30°C
- frost protection: +5°C
- hysteresis: 0.5 K
- protection: IP30
- sensor type: Bimetal
- type of electrical connection: Spring-loaded contacts
- type of conductors: 0.75 - 1.5mm<sup>2</sup> (flexible-stranded core); 1.0 - 2.5 mm<sup>2</sup> (solid core)
- in compliance with the Directive DIN EN 60730

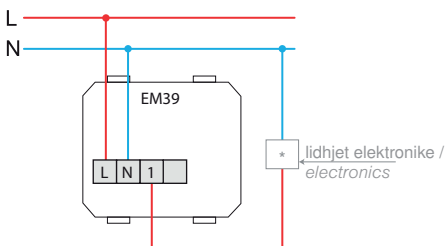

2M = 45 x 45

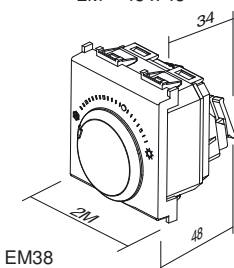

EM38

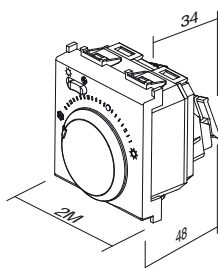

EM39

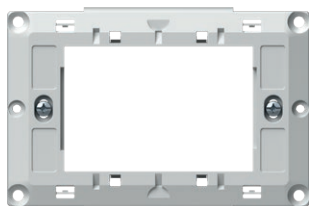

NM39

### KORNIZË MONTIMI ME VIDA PËR TERMOSTATE FANTINI COSMI 3M

- kornizë montimi me vida për termostate Fantini Cosmi 3M
- i përshtatshëm për përdorim me modelet e përditshme të termostateve Fantini Cosmi CH121 dhe CH123
- i përshtatshëm për përdorim me modelet javore të termostateve Fantini Cosmi CH141A dhe CH143A
- për montim në kutitë drejtkëndore 3M
- i përshtatshëm për montimin me kapakët mbulues PURE, Line, Soft

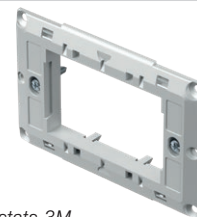

#### MOUNTING FRAME WITH SCREWS FOR FANTINI COSMI THERMOSTATS 3M

- mounting frame with screws for Fantini Cosmi thermostats 3M
- suitable for use with Fantini Cosmi daily thermostats models CH121 and CH123
- suitable for use with Fantini Cosmi weekly thermostats models CH141A and CH143A
- for mounting in rectangular boxes 3M
- suitable for assembling with cover plates PURE, Line, Soft



- EM40PW
- EM40MW
- EM40SB
- EM40AT
- EM40ES
- EM40IW

### ÇELËSI I KARTËS SË KURSIMIT TË ENERGJISË 3 A 250 V~ 3M

- çelës karte bazë, çdo kartë ISO
- tensioni i furnizimit, 230 V ~ 50 Hz
- dalja 3 A 250 V~ për kontaktorin e çelësit \*
- vonesa e fikjes 15-20 sek.
- në përputhje me EN 61000-6-1
- karta nuk është e përfshirë
- jo për kontrollin e aksesit



#### ENERGY SAVER CARD SWITCH 3A 250V~ 3M

- card switch basic, any ISO card
- supply voltage 230V~ 50Hz
- output 3A 250V~ for switching contactor \*
- switch off delay 15-20s
- in accordance with EN 61000-6-1
- card is not included
- not for access control

3M = 67,5 x 45

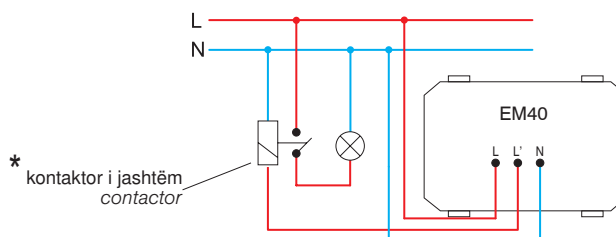
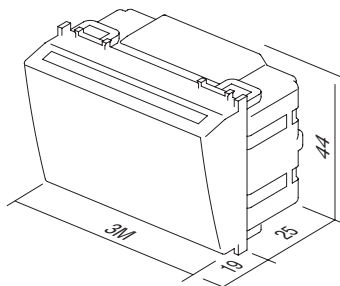



**ÇELËS ME KARTË 16 A / 230 V~, 50 Hz 3M**

- Tensioni i furnizimit: 230 V~, 50 Hz
- Dalja: Rele 16 A / 230 V~, 50 Hz
- Prerje e tërthortë e telit: 0,75 - 4,0 mm<sup>2</sup>
- Temperatura e funksionimit: 0 deri +40°C
- Temperatura e ruajtjes: -5 deri +60°C
- Funksioni: Çelës me kartë me automat me vonesë
- Vonesa e automatit: ~23 s
- Numri i portave: 6; 2x N, 2x L dhe 2x dalje (C dhe NO)
- Konsumi i energjisë në gjendjen FIKUR / NDEZUR: 0,5 W / 1,2 W



**CARD SWITCH 16 A / 230 V~, 50 Hz 3M**

- Supply voltage: 230 V~, 50 Hz
- Output: Relay 16 A / 230 V~, 50 Hz
- Wire cross-section: 0.75 - 4.0 mm<sup>2</sup>
- Operating temperature: 0 to +40°C
- Storage temperature: -5 to +60°C
- Function: Card switch with a delayed break
- Break delay: ~23 s
- Number of ports: 6; 2x N, 2x L and 2x output (C and NO)
- Power consumption in the OFF/ON state: 0.5 W / 1.2 W

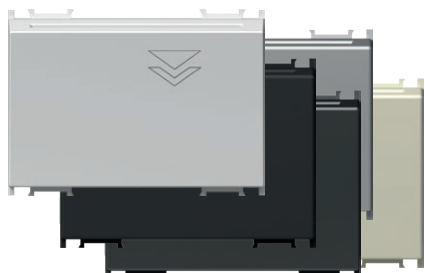

- EM46PW
- EM46MW
- EM46SB
- EM46AT
- EM46ES
- EM46IW

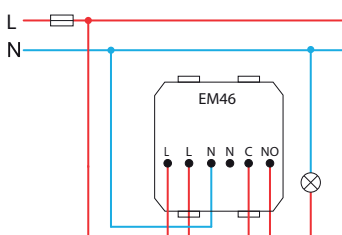
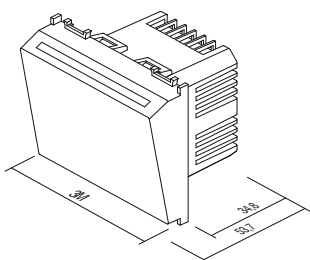

**ÇELËS KARTE PËR KURSIM TË ENERGJISË RF HF 13,56 MHz 3M**

- çelës karte elektronike për kartë RFID ISO
- furnizimi nga njësia e relese EM49 përmes konektorëve të kabllëve RJ12
- dalja të lidhet me njësinë e daljes së relese EM49
- vonesë 15-20 sek. e çelësit "kryesor të energjisë" me heqjen e kartës
- vonesë 1 min. e çelësit "HVAC" me heqjen e kartës kur hapen dyert ose dritaret e ballkonit
- në përputhje me EN 61000-6-1
- karta nuk është e përfshirë
- jo për kontrollin e aksesit



EM44BK

**ENERGY SAVER CARD SWITCH RF HF 13,56MHz 3M**

- electronic card switch for RFID ISO card
- supply from relay unit EM49 through cable connectors RJ12
- output to be connected to relay output unit EM49
- 15-20s "main power" switch off delay with card withdrawal
- 1 min "HVAC" switch off delay with card withdrawal when balcony doors or windows opened
- in accordance with EN 61000-6-1
- card is not included
- not for access control

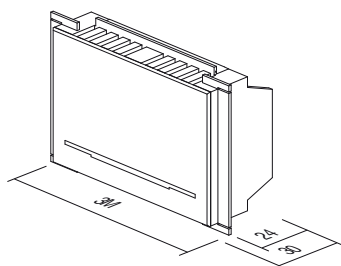

**KARTË ISO**

EM47

- kartë ISO
- për kombinim me çelës karte EM40
- madhësia: 85x54 mm

**CARD ISO**

- ISO card
- for combination with card switch EM40
- size: 85x54 mm

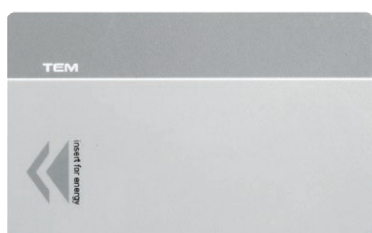

NJËSIA E KONTROLLIT TË KURSIMIT TË ENERGJISË 2x16 A 250 V~



EM49

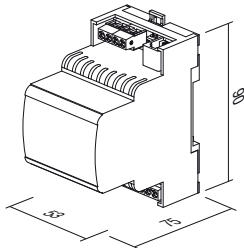

- njësi releje për çelësat e kartës EM44
- tensioni i furnizimit, 230 V ~ 50 Hz
- në përputhje me EN 61000-6-1
- montim në shinë DIN 35 mm, 3MU
- hyrje dhe dalje në varësi të implementimit: dhomë njëshe ose dyshe

ENERGY SAVER CONTROL UNIT 2x16A 250V~

- relay unit for card switches EM44
- supply voltage 230V~ 50Hz
- in accordance with EN 61000-6-1
- mounting on DIN rail 35mm, 3MU
- input and output depending on implementation: single or double room



SHPËRNDARËS SPL-1



EM45

- përdoret për të lidhur dy module periferike EM44 me njësinë e relesë EM49
- konektori i komunikimit RJ12
- madhësia: 37 x 30 x 27 mm

SPLITTER SPL-1

- used to connect two peripheral modules EM44 to relay unit EM49
- communication connector RJ12
- size: 37 x 30 x 27 mm

skema e instalimeve elektrike për implementim në dhomë njëshe / wiring diagram for single room implementation

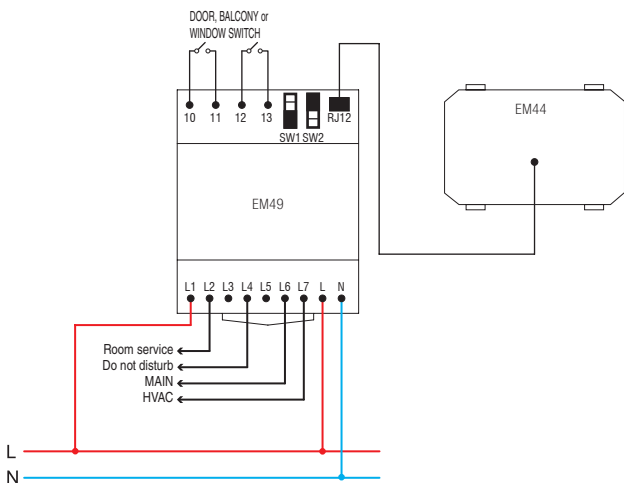

skema e instalimeve elektrike për implementim në dhomë dyshe / wiring diagram for double room implementation

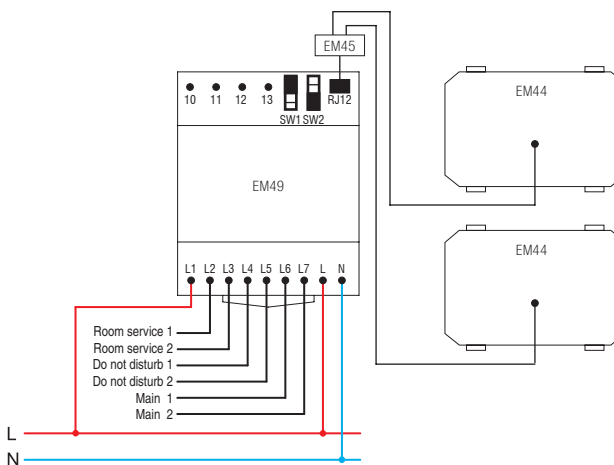

kabloja e lidhjes RJ12 mes EM44 dhe EM49 / connection cable RJ12 between EM44 and EM49

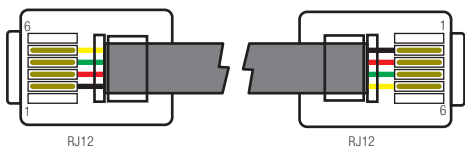

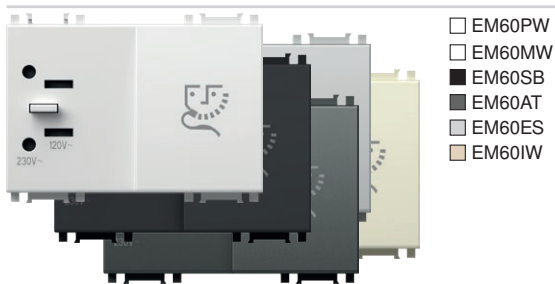

- EM60PW
- EM60MW
- EM60SB
- EM60AT
- EM60ES
- EM60IW

**PRIZË PËR RROJË 230 V~/120 V~ 3M**

- njësi furnizimi për rrojë me transformator izolues 20 VA
- furnizimi: 230 V~ 50-60 Hz
- dalja:
- 230 V~ për 2P 2,5 A spinë Euro ose
- 120V~ për 2P 15 A spinë amerikane
- Klasi II
- në përputhje me EN 61558-2-5



**SOCKET SHAVER 230V~/120V~ 3M**

- shaver supply unit with isolating transformer 20VA
- supply: 230V~ 50-60Hz
- output:
- 230V~ for 2P 2.5A Europlug or
- 120V~ for 2P 15A American plug
- Class II
- in accordance with EN 61558-2-5

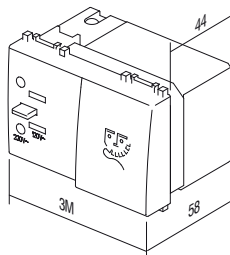

3M = 67,5 x 45

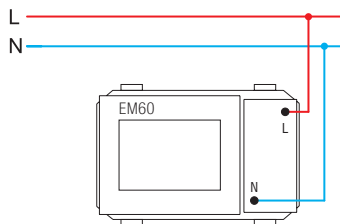

EM57

**DRITË EMERGJENCE LED 230 V~50 Hz, 0,5 W, NiMH 2 ORË 2M**

- llambë emergjence LED
- opion për ta përdorur si llambë koke (mekanizmi me tërheqje)
- tensioni i furnizimit 230 V~50 Hz, 1xLED 0,5 W
- Akumulator NiMH 3,6V 140 mAh, i zëvendësueshëm
- autonomia 2 orë, karikimi 36 orë
- klasi i pajisjes II
- në përputhje me standardet EN60598-1, EN60598-2-2, EN62471, EN55015:2006, EN61547

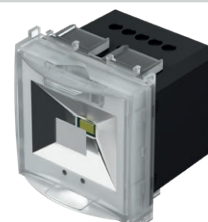

**LED EMERGENCY LIGHT 230V~50Hz, 0.5W, NiMH 2h 2M**

- emergency LED lamp
- option to use it as a hand lamp (pull-out mechanism)
- supply voltage 230V~50Hz, 1xLED 0.5W
- NiMH accumulator 3,6V 140mAh, replaceable
- autonomy 2h, charging 36h
- class device II
- in accordance EN60598-1, EN60598-2-2, EN62471, EN55015:2006, EN61547

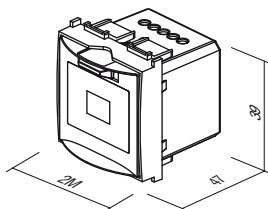
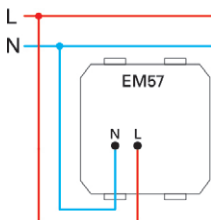

EM55

**DRITË EMERGJENCE LED 250 V~ 0,90 W, NiCd 3h 7M**

- dritë emergjence LED
- tensioni i furnizimit 250 V~ 50 Hz 3x LED 0,3 W, 10000 mcd, 6500K
- akumulator NiCd 4,8V 400 mAh, i ndërrueshëm
- autonomia 3 orë, karikimi 24h
- Klasi II
- në përputhje me standardet EN 60598-1, EN 60598-2-2, EN 60598-2-22



**LED EMERGENCY LIGHT 250V~ 0.90W, NiCd 3h 7M**

- emergency LED lamp
- supply voltage 250V~ 50Hz 3x LED 0,3W, 10000mcd, 6500K
- NiCd accumulator 4,8V 400 mAh, replaceable
- autonomy 3h, charging 24h
- Class II
- in accordance with EN 60598-1, EN 60598-2-2, EN 60598-2-22

7M = 157 X 45

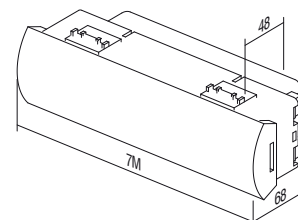
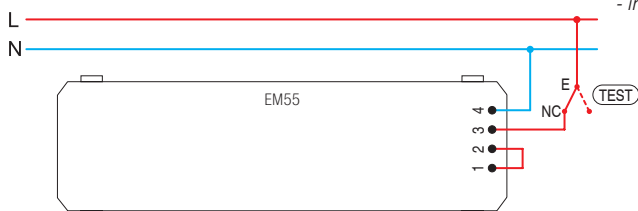



### NJËSIA E FURNIZIMIT ME ENERGJI USB 5 V 2,1 A 1M



- EM67PW
- EM67MW
- EM67SB
- EM67AT
- EM67ES
- EM67IW

- për karikimin e pajisjeve elektronike përmes një porte standarde USB (e përputhshme gjithashtu edhe me pajisjet Apple)
- furnizimi me energji: 100-230 V~ 50/60 Hz
- konsumi i energjisë: 300 mA në 100 V~/150 mA në 230 V~
- konsumi i energjisë në gatihmëri: 30mW në 230 V~
- tensioni nominal në dalje: 5 VDC (±5 %) SELV
- tensioni i ondulacionit në dalje: 150 mV
- rryma nominale në dalje: 2,1 A (1 x 2100 mA) (±10 %)
- efikasiteti: maksimumi 77%
- temperatura e funksionimit: 0°C/+45°C (përdorimi i brendshëm)
- Klasifikimi i mbrojtjes IP: IP20, vetëm për përdorim në ambiente të brendshme
- klasi i pajisjes II
- kategoria e mbitensionit (EN 62109): klasi III
- kontaktet e vidave: maks. 2,5 mm<sup>2</sup>
- pajisje me hapësirë kontakti prej të paktën 3 mm
- në përputhje me standardet EN 60950-1 dhe Direktivës LVC dhe EMC

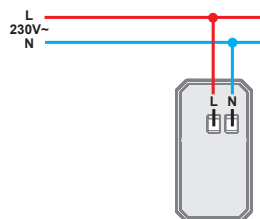
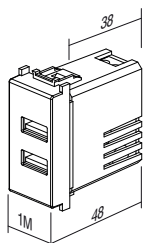

### USB POWER SUPPLY UNIT 5V 2,4A 1M

- for charging of electronic devices via a standard USB port (also compatible with Apple devices)
- power supply: 100-230V~ 50/60Hz
- power consumption: 300mA at 100V~/150mA at 230V~
- standby power consumption: 30mW at 230V~
- nominal output voltage: 5 VCD (± 5%) SELV
- output ripple voltage: 150mV
- nominal output current: 2,4A (±10%)
- efficiency: maximum of 77%
- operating temperature: 0°C/+45°C (indoor use)
- IP protection class: IP20, indoor use only
- class device II
- overvoltage category (EN 62109): Class III
- screw contacts: max. 2.5 mm<sup>2</sup>
- device with a contact gap of at least 3mm
- in accordance with EN 60950-1 and LVD & EMC directives
- not suitable for installation in 45 mm deep boxes and surface mount boxes CUBO IP20

### NJËSIA E FURNIZIMIT ME ENERGJI USB 5 V 3,0 A



- EM68PW
- EM68MW
- EM68SB
- EM68AT
- EM68ES
- EM68IW

- Furnizimi 100 – 230 V ~ 50/60 Hz
- Konsumi: 300 mA në 100V~ / 150 mA në 230 V~
- Konsumi në gjendje gatishmërie: 30 mW në 230 V~
- Tensioni nominal dalës: 5 ~ (±5%) SELV
- Valëzimi (ripple) i tensionit dalës: 150 mV
- Fuqija nominale dalëse:
  - EM68 , EQ68 , EE68: 3,0 A (±10 %) ; (lloji USB A / USB C)
- Efikasiteti: maks. 77%
- Temperatura e punës: 0°C/+45°C (përdorimi i brendshëm)
- Kategoria e mbrojtjes IP: IP20, vetëm për përdorim të brendshëm
- Kategoria e sigurisë së pajisjes II
- Kategoria e mbitensionit (EN 62109): kategoria III
- Fiksimi me vidë i përcjellësit me diametër 2,5 mm<sup>2</sup>
- Pajisje me distancë kontakti prej së paku 3 mm

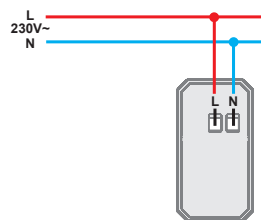
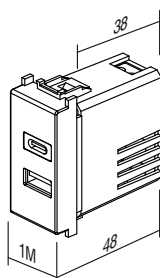

### USB POWER SUPPLY UNIT 5V 3,0A

- power supply: 100-230V~ 50/60Hz
- power consumption: 300mA at 100V~/150mA at 230V~
- standby power consumption: 30mW at 230V~
- nominal output voltage: 5 ~ (±5%) SELV
- output ripple voltage: 150mV
- nominal output current:
  - EM68 , EQ68 , EE68: 3,0 A (±10 %) ; (Type USB A / USB C)
- efficiency: maximum of 77%
- operating temperature: 0°C/+45°C (indoor use)
- IP protection class: IP20, indoor use only
- class device II
- overvoltage category (IEC 60364-4-44) CAT II
- a low-voltage SPD (surge protective devices) in accordance with the EN 61643-11 intended to reduce the overvoltage category III to II must be installed upstream of the USB device
- screw contacts: max. 2.5 mm<sup>2</sup>
- device with a contact gap of at least 3mm



- EM69PW
- EM69MW
- EM69SB
- EM69AT
- EM69ES
- EM69IW

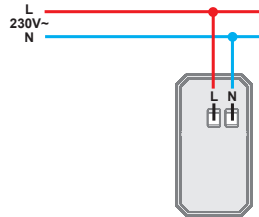
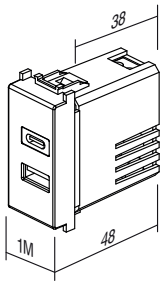

## NJËSIA E FURNIZIMIT ME ENERGJI USB PD 20W

- Njësia e furnizimit me energji USB 20 W
- për karikimin e pajisjeve elektronike përmes një porte standarde USB (e përputhshme gjithashtu edhe me pajisjet Apple)
- furnizimi me energji: 100-230 V~ 50/60 Hz
- konsumi i energjisë: 420 mA në 100 V~/220 mA në 230 V~
- konsumi i energjisë në gatishmëri: <100 mW në 230 V~
- Fuqia maksimale: 20 W Maks.
- Dalja:
- USB lloji C: 5.0 VDC 3.0 A; 9.0 VDC 2.2 A; 12.0 VDC 1.67 A (PD 20 W)
- USB lloji A: 5.0 VDC 3.0 A; 9.0 VDC 2.0 A; 12.0 VDC 1.5 A (QC 18 W)
- USB A+C: 5 VDC 3 A
- lloji i konektorit: 1x USB A; 1x USB C
- efikasiteti mesatar në regjim aktiv: 86%
- efikasiteti me ngarkesë të ulët (10%): 81%
- temperatura e funksionimit: 0°C/+45°C (përdorimi i brendshëm)
- Klasi i mbrojtjes IP: IP20, vetëm për përdorim në ambiente të brendshme
- klasi i pajisjes II
- kategoria e mbritensionit (EN 60364-4-44): Klasi III
- kontaktet e vidave: maks. 2.5 mm<sup>2</sup>
- pajisje me hapësirë kontakti prej të paktën 3 mm
- Konformiteti:
- Direktiva: BT, EMC, RoHS, ErP
- Standardet: EN IEC 62368-1, EN 55032, EN55035, EN IEC 61000-3-2, EN 61000-3-3, EN 50563, EN IEC 63000
- Rregulloret e furnizimeve të jashtme me energji: (EU) n. 2019/1782 REACh, n. 1907/2006 – neni 33. Produkti mund të përmbajë gjurmë plumbi.



## USB POWER SUPPLY UNIT PD 20W

- 20 W USB power delivery power supply unit
- for charging of electronic devices via a standard USB port (also compatible with Apple devices)
- power supply: 100-230V~ 50/60Hz
- power consumption: 420mA at 100V~/220mA at 230V~
- standby power consumption: <100mW at 230V~
- Output power: 20 W Max
- Output:
- USB tip C: 5.0 VDC 3.0A; 9.0 VDC 2.2 A; 12.0 VDC 1.67 A (PD 20W)
- USB tip A: 5.0 VDC 3.0A; 9.0 VDC 2.0 A; 12.0 VDC 1.5 A (QC 18W)
- USB A+C: 5 VDC 3A
- connector type: 1x USB A; 1x USB C
- average efficiency in active mode: 86%
- efficiency with low load (10%): 81%
- operating temperature: 0°C/+45°C (indoor use)
- IP protection class: IP20, indoor use only
- class device II
- overvoltage category (EN 60364-4-44): Class III
- screw contacts: max. 2.5 mm<sup>2</sup>
- device with a contact gap of at least 3mm
- Conformity:
- Directive: BT, EMC, RoHS, ErP
- Standards: EN IEC 62368-1, EN 55032, EN55035, EN IEC 61000-3-2, EN 61000-3-3, EN 50563, EN IEC 63000
- External power supplies regulation: (EU) n. 2019/1782 REACh, n. 1907/2006 – art.33. The product may contain traces of lead.

**NJËSI LED NJËNGJYRËSHE AMBIENT**

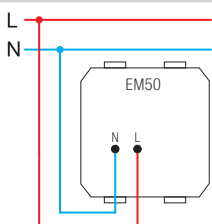
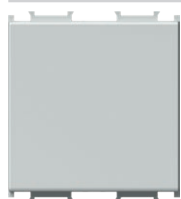

- EM50WH
- EM50BL
- EM50RD
- EM50GR

- llambë LED shënuese
- tensioni i furnizimit, 230 V ~ 50 Hz, 0,8 W, 6500K
- Klasi II
- në përputhje me EN 60598-1
- përdorim opsional për ndriçimin e drejtimt ose sinjalit me printim të personalizuar me lazer në difuzor

*LED AMBIENT UNIT MONOCOLOUR  
250V~ 0,8W 2M*

- step marker LED unit
- supply voltage 230V~ 50Hz 0,8W, 6500K
- Class II
- in accordance with EN 60598-1
- optional usage for directional signalization with customized laser printing on diffuser



**LLAMBË LED ME DY NGJYRA 250 V~ 2 x 0,4 W 2M**

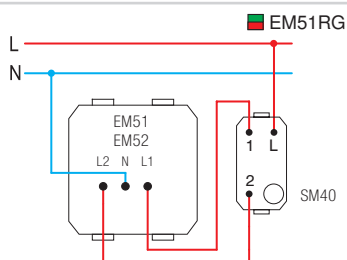

- EM51RG

- llambë LED sinjalizuese me dy ngjyra (e kuqe/e gjelbër)
- tensioni i furnizimit, 230 V ~ 50 Hz, 0,8 W, 6500K
- Klasi II
- në përputhje me EN 60598-1
- difuzori përfshin grafikët siç tregohet
- mundësi për printim të personalizuar me lazer në difuzor

*LED LAMP DUAL COLOR 250V~ 2x0,4W 2M*

- signaling dual color (red/green) LED lamp
- supply voltage 230V~ 50Hz 2x0,4W, 6500K
- Class II
- in accordance with EN 60598-1
- diffuser includes graphics as shown
- possible customized laser printing on diffuser



**LLAMBË LED 3D ME DY NGJYRA 250 V~ 2 x 0,4 W 2M**

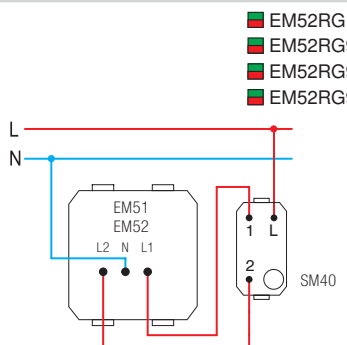

- EM52RG
- EM52RG90
- EM52RG91
- EM52RG99

- llambë LED sinjalizuese me dy ngjyra (e kuqe/e gjelbër) me simbol 3D
- tensioni i furnizimit, 230 V ~ 50 Hz, 0,8 W, 6500K
- Klasi II
- në përputhje me EN 60598-1
- mundësi për grafikë të personalizuar sipas kërkesës
- 90 simbol mashkull, 91 simbol femër, 99 simbol sipas kërkesës

*LED LAMP 3D DUAL  
COLOR 250V~ 2x0,4W 2M*

- signalling LED lamp, dual color (red/green) with 3D symbol
- supply voltage 230V~ 50Hz 2x0,4W, 6500K
- class II
- in accordance with EN 60598-1
- possible customized graphics on request
- 90 male symbol, 91 female symbol, 99 symbol on request

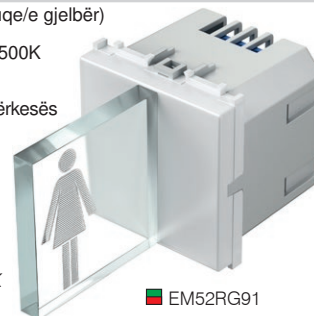

■ EM52RG91

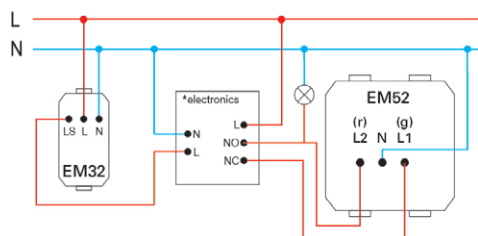

■ EM52RG90

2M = 45 x 45

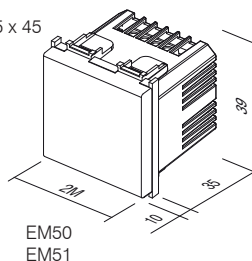

EM50  
EM51

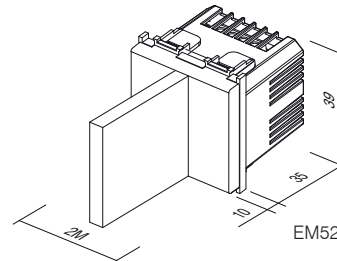

EM52



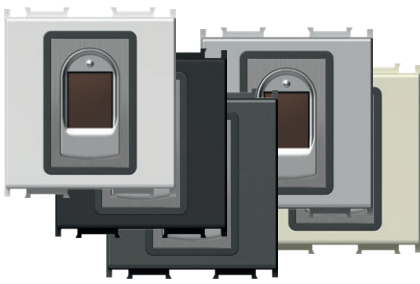

- EM71PW
- EM71MW
- EM71SB
- EM71AT
- EM71ES
- EM71IW

**ÇELËS ME GJURMË GISHTI BIOPASS 2M**

- çelës me gjurmë gishti me njësi releje të brendshme dhe furnizim me energji
- Kapaciteti: 500 gjurmë gishtash
- Menaxhim i lehtë përmes aplikacionit për celular X-Manager
- Tensioni i furnizimit me energji: 8-30 V – DC ose AC (përfshihet furnizimi me energji)
- Sensor me prekje kapacitative
- Rele me 2 dalje
- Tensioni/rryma maksimale në rele: 40 V/3 A
- Koha e aktivizimit të relesës: 1-10 sek.
- Fuqja maksimale: 3,6 W
- lidhje e enkriptuar 256-bit mes çelësit dhe njësisë së relesës së brendshme
- Seti përfshin gjithashtu kornizën e montimit NM24 dhe pllakën e kapakut dekorativ OS20.

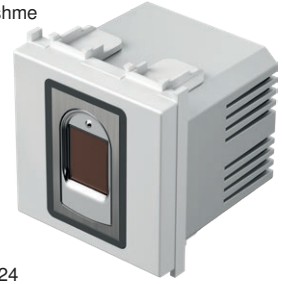

**FINGERPRINT SWITCH BIOPASS 2M**

- fingerprint switch with included internal relay unit and power supply
- capacity: 500 fingerprints
- easy management via X-Manager mobile app
- power supply voltage: 8-30V – DC or AC (power supply included)
- capacitive sensor
- 2 output relays
- maximum voltage/current on relay: 40V/3A
- relay triggering time: 1-10 sec
- maximum power: 3.6W
- 256-bit encrypted link between switch and internal relay unit
- Set also includes NM24 mounting frame and OS20 decorative cover plate.

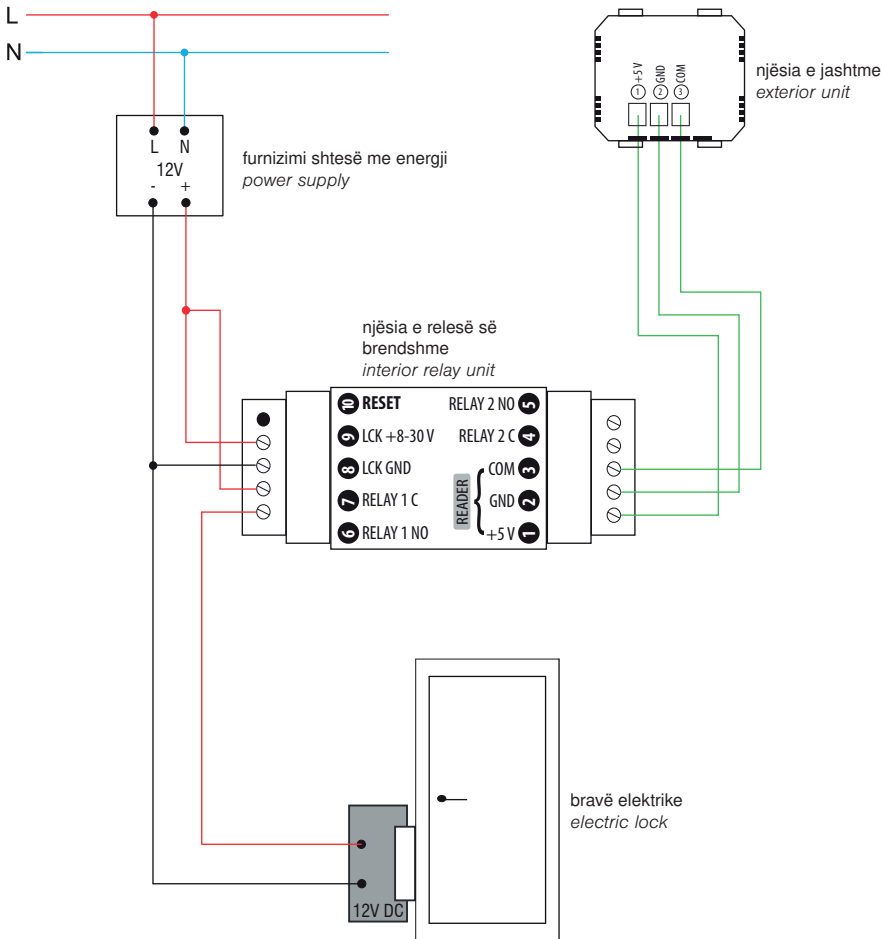

X-Manager app



njësia e jashtme exterior unit

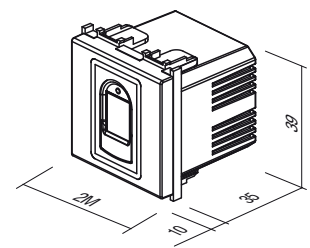



- EM82PW
- EM82MW
- EM82SB
- EM82AT
- EM82ES
- EM82IW



KOHËMATËS ME SHUMË FUNKSIONE EM82

- Tensioni i furnizimit: 230 V~, 50Hz
- Dalja: Rele 16 A/250 V~, 50 Hz
- Seksioni kryq i tellit: 0,75 – 4.0 mm<sup>2</sup>
- Temperatura e funksionimit: 0°C deri +40°C
- Temperatura e ruajtjes: -5°C deri +60°C
- Funksionet: **kohëmatës, releja (çelësi i kontrolluar), çelësi, butoni me shtypje**
- Treguesi i programit/statusit: RGB LED
- Numri i butonave: 2
- Tipi i funksionimit të butonit me shtypje: Me prekje kapacitive
- Numri i portave: 6 - 2x N, 2x L, 1x dalje (L'), 1x hyrje e kontrolluar (S)
- Opsioni i hyrjes së kontrolluar: Po. Lidhja e sinjalit kryesor të tensionit (230 V~) me terminalin S.
- U zbatua funksioni "zero kalim" (takim-stakimi i çelësit kur tensioni kalon përmes 0 V)
- Konsumi i energjisë në gjendjen FIKUR / NDEZUR: 0.3 W / 1.0 W
- Çelësi EM82 NUK ËSHTË I PAPËRSHTATSHËM për instalim në kuti të fshehura me një thellësi prej 45 mm dhe fole CUBO IP20.
- Çelësi është synuar për përdorim në ambiente të brendshme, me mbrojtje nga lagështira.

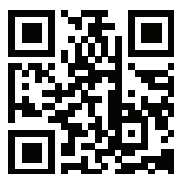

MULTIPURPOSE TIMER SWITCH EM82

- Supply voltage: 230 V~, 50Hz
- Output: Rele 16 A / 250 V~, 50Hz
- Wire cross section: 0,75 – 4.0 mm<sup>2</sup>
- Operating temperature: 0 to + 40 °C
- Storage temperature: -5 to + 60 °C
- Functions: **Timer, Relay (controlled switch), Switch, Push button**
- Program/status indication: RGB LED
- Number of buttons: 2
- Push button operation type: Capacitive
- Number of ports: 6 - 2x N, 2x L, 1x Output (L'), 1x Controlled input (S)
- Controlled input option: Yes. Connection of the main voltage signal (230 V~) to terminal S.
- Implemented "zero crossing" operation (switching the switch when the voltage passes through 0 V)
- Power consumption in the OFF / ON state: 0.3 W / 1.0 W
- The EM82 switch is NOT SUITABLE for installation in concealed boxes with a depth of 45 mm and CUBO IP20 housing.
- The switch is intended for indoor use, protected from moisture.

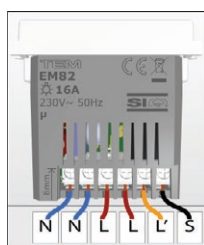
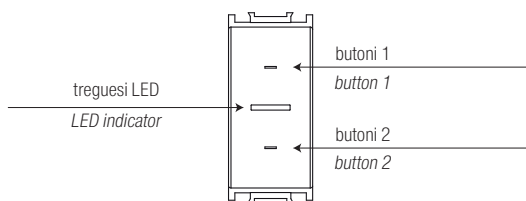

- N Përçuesi neutral
- L Përçuesi i fazës
- L' Dalja (faza e kontrolluar)
- S Sinjali i kontrollit të hyrjes (230 V~)

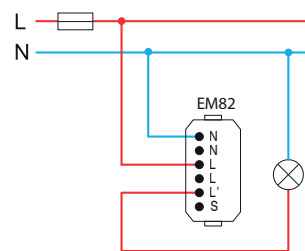

EM82 is in a SWITCH or a TIMER mode

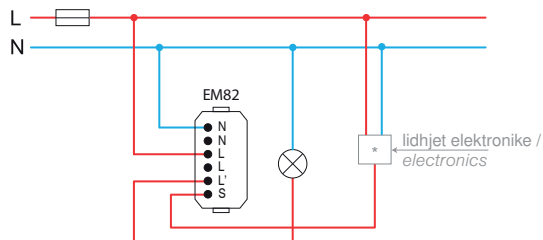

EM82 is in a RELAY mode

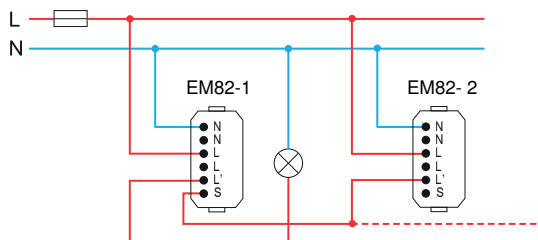

EM82-1 is in a SWITCH or a TIMER mode  
EM82-2 is in a PUSH BUTTON mode

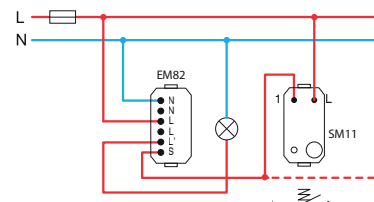

EM82 is in a SWITCH or a TIMER mode

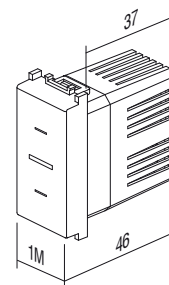

	12	3	4	5	6	7	8	
Max.	16 A	16 A	16 A	8 A	8 A	5 A	200 VA	200 VA

- 1 - incandescent lamp
- 2 - halogen lamp
- 3 - resistive heating element
- 4 - electronic transformer
- 5 - classical transformer
- 6 - motor
- 7 - energy saving CFL lamp
- 8 - LED lamp

Operation of the control signal S – MODE 1

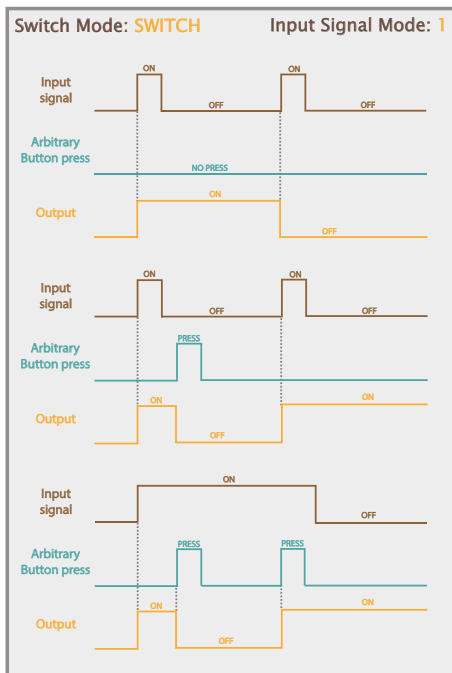

Display of the operation of the external signal S and buttons in the SWITCH operating mode and external signal in MODE 1

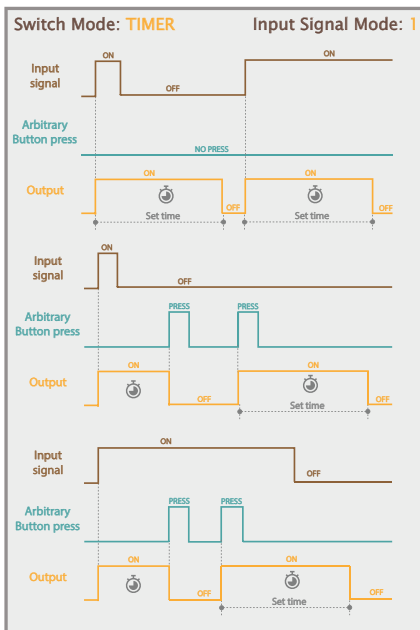

Display of the operation of the external signal S and buttons in the TIMER operating mode and external signal in MODE 1

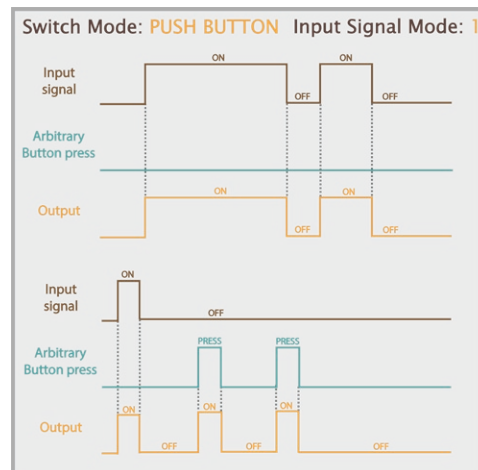

Display of the operation of the external signal S and buttons in the PUSH BUTTON operating mode and external signal in MODE 1

OPERATION OF THE CONTROL SIGNAL S – MODE 2

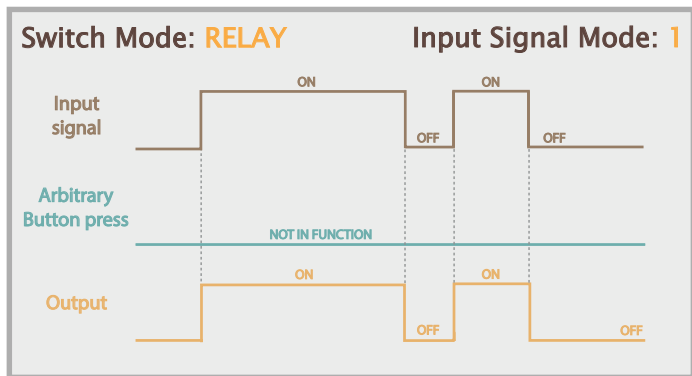

Display of the operation of the external signal S and buttons in the RELAY operating mode and external signal in MODE 1

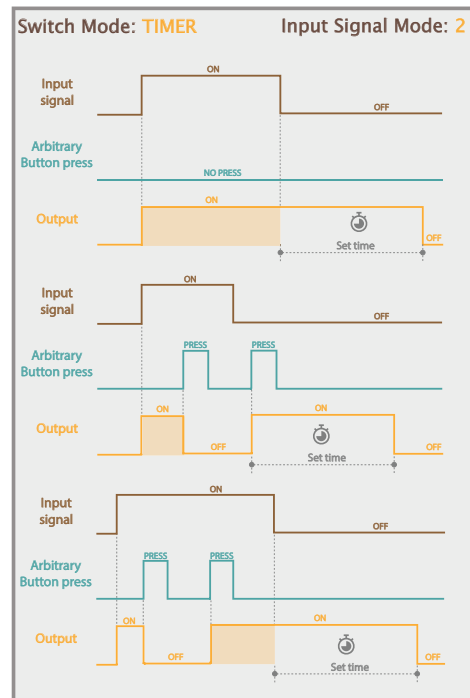

Display of the operation of the external signal S and buttons in the TIMER operating mode and external signal in MODE 2

Operating mode settings of the external control signal S

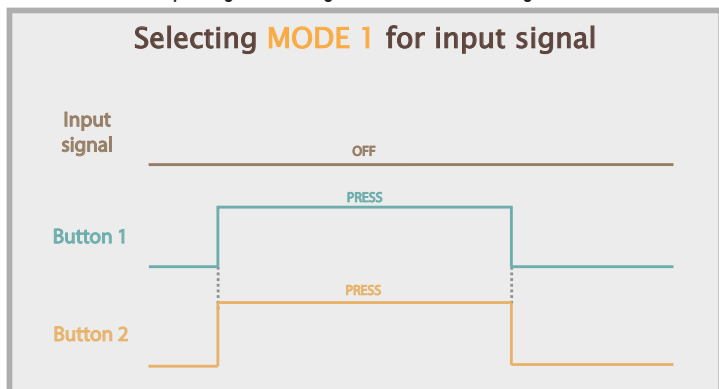

Setting the operating mode of the input signal S for MODE 1

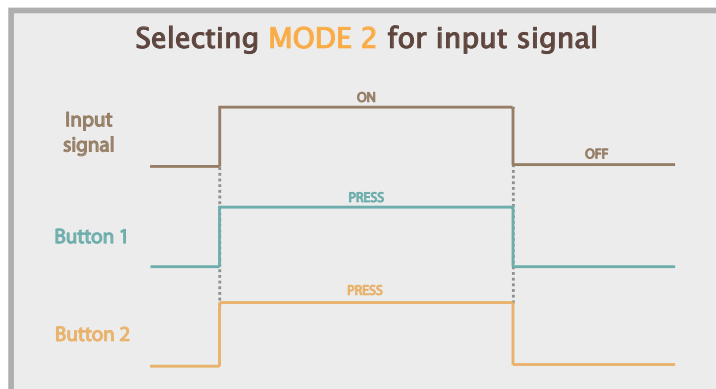

Setting the operating mode of the input signal S for MODE 2



### ÇELËS, PA PREKJE 10 A 240 V~



■ EM80GW

- çelës pa prekje për ndezje/fikje ("master")
- furnizimi me energji: 240 V~ 50 Hz
- releja e daljes 10 A / 250 V~ (2400 W në 240 V~)
- gama e rregullueshme nga 2 deri 10 cm
- për instalimin në kuti të rumbullakët standarde Ø60 mm
- për lidhjen kërkohet një tel nul (N)
- nuk është e mundur lidhja me çelës me 2 drejtime
- është e mundur lidhja me deri në 5 çelësa kontrolli EM81
- instalim i lehtë i kapakëve dekorativë me ndihmën e magnetëve
- shtrëngimi i vidave të telave deri në 2,5 mm<sup>2</sup> (maks. forca e shtrëngimit të vidës është 0,4 Nm)
- në përputhje me standardet EN 60669-1 dhe EN 60669-2-1
- vetëm për përdorim të brendshëm



#### SWITCH, TOUCHLESS 10A 240V~

- touchless switch for turning on/off ("master")
- power supply: 240 V~ 50 Hz
- output relay 10A / 250V~ (2400W at 240V~)
- adjustable range from 2 to 10 cm
- intended for installation into a standard round Ø60 mm box
- a neutral lead (N) is required for connection
- connection with toggle switches is not possible
- connection with up to 5 EM81 control switches is possible
- simple installation of decorative covers with the help of magnets
- screw fastening of leads up to 2,5 mm<sup>2</sup> (max. screw tightening torque is 0.4 Nm)
- in accordance with EN 60669-1 and EN 60669-2-1
- only for indoor use

### ÇELËS, PA PREKJE, NJËSI KONTROLLI



■ EM81GW

- çelësi i kontrollit ("slave")
- funksionon vetëm kur lidhet me çelësin EM80 ("master")
- gama e rregullueshme nga 2 deri 10 cm
- instalim i lehtë i kapakëve dekorativë me ndihmën e magnetëve
- shtrëngimi i vidave të telave deri në 2,5 mm<sup>2</sup> (forca maks. e shtrëngimit të vidës është 0,4 Nm)
- në përputhje me standardet EN 60669-1 dhe EN 60669-2-1
- vetëm për përdorim të brendshëm



#### SWITCH, TOUCHLESS, CONTROL UNIT

- control switch ("slave")
- works only when connected with the EM80 switch ("master")
- adjustable range from 2 to 10 cm
- simple installation of decorative covers with the help of magnets
- screw fastening of leads up to 2.5 mm<sup>2</sup> (max. screw tightening torque is 0.4 Nm)
- in accordance with EN 60669-1 and EN 60669-2-1
- only for indoor use

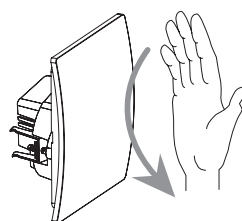
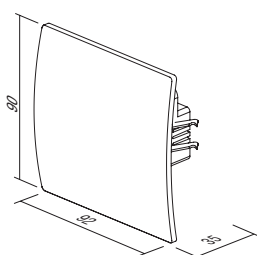
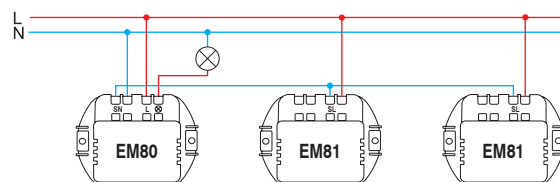
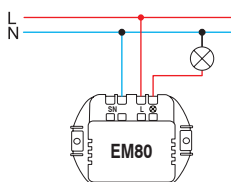

SINJALIZUES 8 VA 230 V~1M

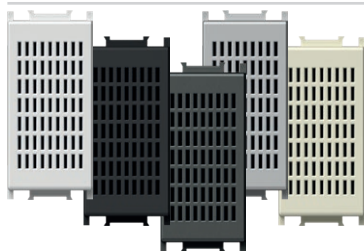

- EM90PW
- EM90MW
- EM90SB
- EM90AT
- EM90ES
- EM90IW

- sinjalizues  
 - dalja e tingullit ka të njëjtën kohëzgjatje si funksionimi i kontrollit  
 - tensioni i furnizimit, 230V ~ 50 Hz 8 VA  
**BUZZER 8VA 230V~1M**  
 - signal buzzer  
 - the sound emission has the same lasting time as the control operation  
 - supply voltage 230V~ 50Hz 8VA



SINJALIZUES 8 VA 12V~1M

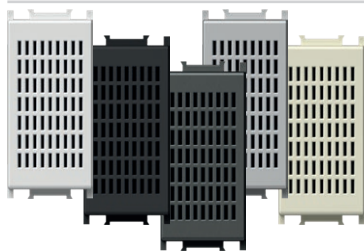

- EM91PW
- EM91MW
- EM91SB
- EM91AT
- EM91ES
- EM91IW

- sinjalizues  
 - dalja e tingullit ka të njëjtën kohëzgjatje si funksionimi i kontrollit  
 - tensioni i furnizimit, 230V ~ 50 Hz 8 VA  
**BUZZER 8VA 12V~1M**  
 - signal buzzer  
 - the sound emission has the same lasting time as the control operation  
 - supply voltage 12V~ 50Hz 8VA



ZILE 8 VA 230 V~1M

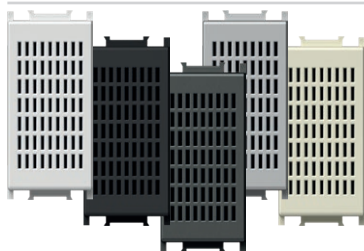

- EM92PW
- EM92MW
- EM92SB
- EM92AT
- EM92ES
- EM92IW

- zile sinjalizuese  
 - dalja e tingullit ka të njëjtën kohëzgjatje si funksionimi i kontrollit  
 - tensioni i furnizimit, 230V ~ 50 Hz 8 VA  
**BELL 8VA 230V~1M**  
 - signal bell  
 - the sound emission has the same lasting time as the control operation  
 - supply voltage 230V~ 50Hz 8VA



ZILE 8 VA 12V~1M

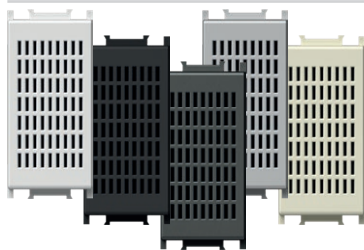

- EM93PW
- EM93MW
- EM93SB
- EM93AT
- EM93ES
- EM93IW

- zile sinjalizuese  
 - dalja e tingullit ka të njëjtën kohëzgjatje si funksionimi i kontrollit  
 - tensioni i furnizimit, 12V ~ 50 Hz 8 VA  
**BELL 8VA 12V~1M**  
 - signal bell  
 - the sound emission has the same lasting time as the control operation  
 - supply voltage 12V~ 50Hz 8VA

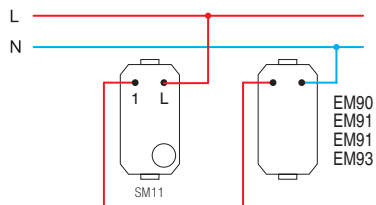
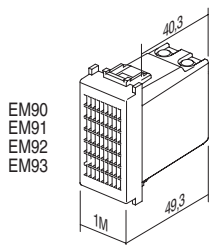

ZILE ELEKTRONIKE 230V~ 6mA rms 1M

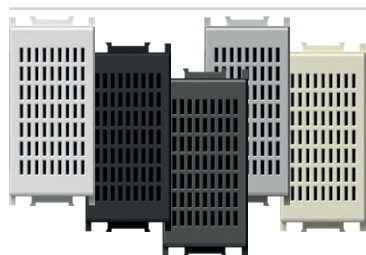

- EM94PW
- EM94MW
- EM94SB
- EM94AT
- EM94ES
- EM94IW

- Furnizimi me energji elektrike 230 V ~ 50/60 Hz
- Konsumi i melodisë 1: 4.7 mA rms
- Konsumi i melodisë 2: 5.9 mA rms
- Niveli i tingullit të melodisë 1: 90.5 dB
- Niveli i tingullit të melodisë 2: 86 dB
- Temperatura e funksionimit nga: 0°C deri në 45°C (përdorim i brendshëm)
- Temperatura e magazinimit nga -20°C deri në 50°C
- Klasa e mbrojtjes IP: IP20 (vetëm për përdorim të brendshëm)
- Klasa e sigurisë së pajisjes: II
- Kategoria e mbritensionit (EN 62109); klasa III
- Mbërthimi me vidë i përcjellësit, maks. 2.5 mm<sup>2</sup>
- Pajisja me distancë kontakti prej të paktën 3 mm
- Një çelës lehtësisht i aksesueshëm me stakim duhet të instalohet në pjesën e sipërme nga zilia
- në përputhje me direktivat EMC dhe LVD

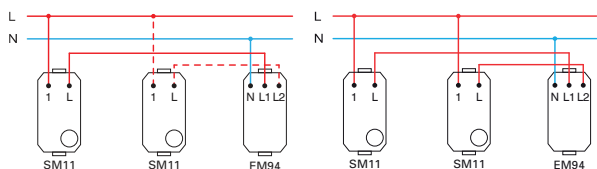
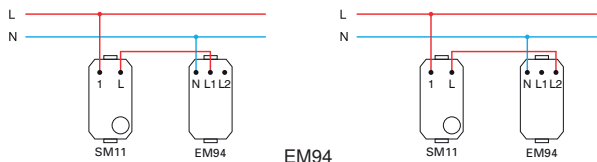

ELECTRONIC BELL 230V~ 6mA rms 1M

- power supply 230 V~ 50/60 Hz
- power consumption when playing melody 1: 4.7 mA rms
- power consumption when playing melody 2: 5.9 mA rms
- sound level of melody 1: 90.5 dB
- sound level of melody 2: 86 dB
- operating temperature 0°C/45°C (indoor use)
- storage temperature: -20°C /50°C
- IP protection class: IP20 (indoor use only)
- class device II
- overvoltage category (EN62109): Class III
- screw contacts: max. 2.5 mm<sup>2</sup>
- device with a contact gap of at least 3 mm
- an easily accessible cut-off switch must be installed upstream from bell
- complies with EMC & LVD directives

KONTROLL VOLUMI 100 V LINJË AUDIO 35 W 2M

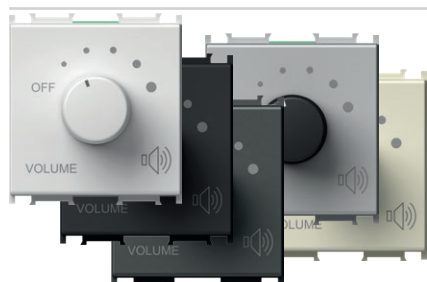

- EM95PW
- EM95MW
- EM95SB
- EM95AT
- EM95ES
- EM95IW

- kontroll volumi (atenuator) për sisteme audio 100 V
- vlerësimi i fuqisë 35 W (maks. 45 W), 6 hapa kontrolli volumi
- i përshtatshëm për kuti (min. 60 mm thellësi)
- i papërshtatshëm për instalim në kuti me thellësi 45 mm dhe kuti montimi në sipërfaqe CUBO IP20
- vetëm për përdorim të brendshëm

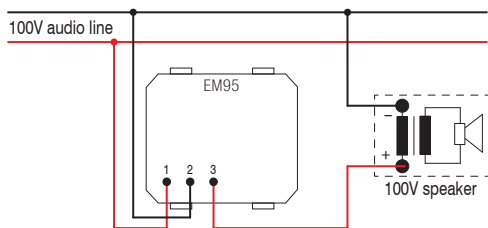

VOLUME CONTROL 100V AUDIO LINE 35W 2M

- volume control (attenuator) for 100V audio systems
- power rating 35W (max.45W), 6 steps volume control
- suitable for boxes min. 60 mm deep
- not suitable for installation in 45 mm deep boxes and surface mount boxes CUBO IP20
- for indoor use only

KONTROLL VOLUMI 4-8 Ω 35 W 2M



- EM96PW
- EM96MW
- EM96SB
- EM96AT
- EM96ES
- EM96IW

- kontroll volumi (atenuator) për dalje të tensionit të ulët 4-8 Ω, 35 W
- mundësi lidhjeje me pajisjet HI-FI
- fuqi nominale 35 W, kontroll i volumit me 6 hapa
- i përshtatshëm për kuti (min. 60 mm thellësi)
- i papërshtatshëm për instalim në kuti me thellësi 45 mm dhe kuti montimi në sipërfaqe CUBO IP20
- vetëm për përdorim të brendshëm

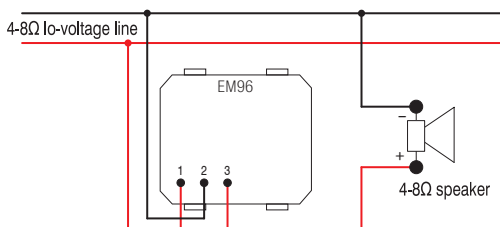

VOLUME CONTROL 4-8 Ω 35W 2M

- volume control (attenuator) for low voltage outputs 4-8 Ω, 35W
- power rating 35W, 6 steps volume control
- suitable for boxes min. 60 mm deep
- not suitable for installation in 45 mm deep boxes and surface mount boxes CUBO IP20
- for indoor use only

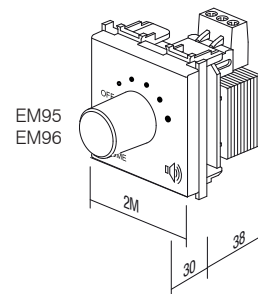



## S E T S C M

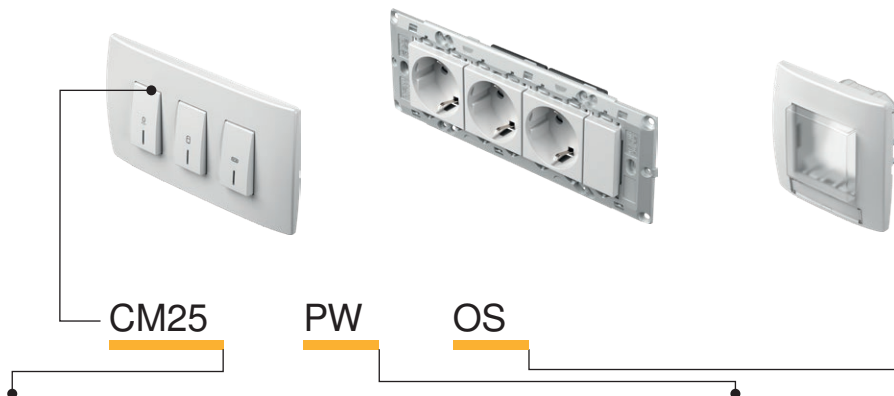

Iloji type	përshkrimi description	të dhënat teknike technical data	madhësia size	ngjyra colour	të dhënat opsionale 1 optional data 1
CM10	SET PRIZË 2x SCHUKO SOCKET SET 2x SCHUKO	2P+E 16A 250V~	4M	<input type="checkbox"/> PW e bardhë polare polar white	<input type="checkbox"/> OL kapak mbulues LINE cover plate LINE
CM11	SET PRIZË 3x SCHUKO SOCKET SET 3x SCHUKO	2P+E 16A 250V~	7M	<input type="checkbox"/> MW e bardhë mat matte white	<input type="checkbox"/> OS kapak mbulues SOFT cover plate SOFT
CM15	SET LIDHJEJE LINK WIRE SET	3x1.5mm <sup>2</sup>	1M	<input checked="" type="checkbox"/> SB e zezë soft touch soft touch black	
·	·	·	·	<input checked="" type="checkbox"/> AT antracit anthracite	
·	·	·	·	<input type="checkbox"/> ES e argjendtë elox elox silver	
·	·	·	·	<input type="checkbox"/> IW e bardhë fildishi ivory white	

## SET PRIZASH 2x SCHUKO 2P+E 16 A 250 V~ 4M

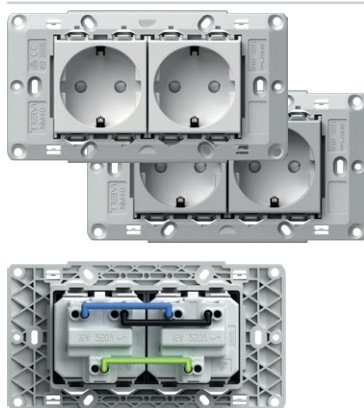

- CM10PW
- CM10ES

- set prizash 2x schuko VM10 2P+E 16 A 250 V~
- pajisur paraprakisht me lidhje telash CM16
- me kornizë montimi 4M pa vida
- për montimin e kornizës përdorni vida CM17, CM18 ose CM19
- kontaktet e vidave 1,5-2,5 mm<sup>2</sup>
- në përputhje me IEC 60884-1, CEE7

## SOCKETS SET 2x SCHUKO 2P+E 16A 250V~ 4M

- socket set 2x schuko VM10 2P+E 16A 250V~
- prewired with link wires CM16
- with mounting frame 4M without screws
- for mounting frame fixing use screws CM17, CM18 or CM19
- screw contacts 1.5-2.5 mm<sup>2</sup>
- in accordance with IEC-60884-1, CEE7

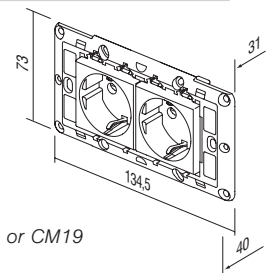

## SET PRIZASH 3x SCHUKO 2P+E 16 A 250 V~ 7M

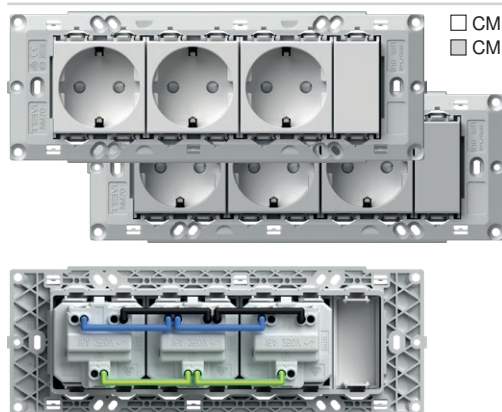

- CM11PW
- CM11ES

- set prizash 3x schuko VM10 2P+E 16 A 250 V~
- pajisur paraprakisht me lidhje telash CM16
- me kornizë montimi 7M pa vida
- për montimin e kornizës përdorni vida CM17, CM18 ose CM19
- kontaktet e vidave 1,5-2,5 mm<sup>2</sup>
- në përputhje me IEC 60884-1, CEE7

## SOCKETS SET 3x SCHUKO 2P+E 16A 250V~ 7M

- socket set 3x schuko VM10 2P+E 16A 250V~
- prewired with link wires CM16
- with mounting frame 7M without screws
- for mounting frame fixing use screws CM17, CM18 or CM19
- screw contacts 1.5-2.5 mm<sup>2</sup>
- in accordance with IEC-60884-1, CEE7

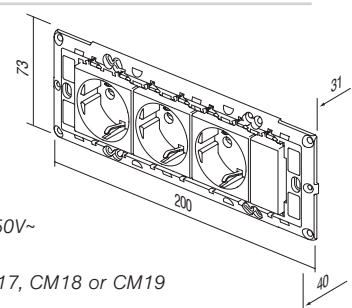

**SET LIDHJEJE 3x1,5 mm<sup>2</sup> 1M**

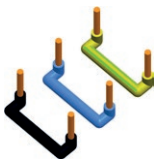

CM15

- set lidhjeje për të lidhur dy elemente madhësia 1M
- përfshin 10 tela të zi, 10 blu dhe 10 të verdhë/të gjelbër

**LINK WIRE SET 3x1.5mm<sup>2</sup> 1M**

- link wire set to connect two elements size 1M
- includes 10 black, 10 blue and 10 yellow/green wires

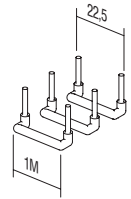

**SET LIDHJEJE 3x2,5 mm<sup>2</sup> 2M**

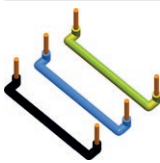

CM16

- set lidhjeje për të lidhur dy elemente madhësia 2M
- përfshin 10 tela të zi, 10 blu dhe 10 të verdhë/të gjelbër

**LINK WIRE SET 3x2.5mm<sup>2</sup> 2M**

- link wire set to connect two elements size 2M
- includes 10 black, 10 blue and 10 yellow/green wires

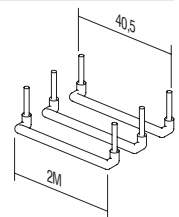

**SET VIDASH 3,5**



CM17  
CM18  
CM19

- set vidash për fiksimin e kornizave të montimit NM30, NM32, NM40, NM41, NM70
- CM17 - l=20mm, 100 copë
- CM18 - l=35mm, 50 copë
- CM19 - l=50mm, 50 copë

**SCREW SET 3,5**

- screw set for fixing mounting frames NM30, NM32, NM40, NM41, NM70
- CM17 - l=20mm, 100pcs
- CM18 - l=35mm, 50pcs
- CM19 - l=50mm, 50pcs

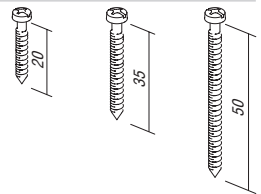

**SET ÇELËSASH IP44 2M**



- CM22PW
- CM22MW
- CM22SB
- CM22AT
- CM22ES
- CM22IW

- për përdorim në zona me lagështirë
- të gjithë çelësat Modul janë të pajisur me mbrojtje IP44
- çelësat dhe butonat nuk janë pjesë e setit
- kapak mbulues SOFT 2M me pllakë me mbishkrim
- në përputhje me IEC 60669-1

**SET SWITCHES IP44 2M**

- for usage in humid areas
- IP44 protection provides for all Modul switches
- switches and buttons are not part of the set
- SOFT 2M cover plate with inscription plate
- in accordance with IEC 60669-1



**SET PRIZASH IP44 2M**



- CM23PW
- CM23MW
- CM23SB
- CM23AT
- CM23ES
- CM23IW

- për përdorim në zona me lagështirë
- mbrojtja IP44 mund të arrihet vetëm në kombinim me prizën e mbuluar (VM11, VM41)
- prizat nuk janë pjesë e setit
- kapak mbulues SOFT 2M me pllakë me mbishkrim
- në përputhje me IEC 60884-1

**SET SOCKETS IP44 2M**

- for usage in humid areas
- IP44 protection can be achieved only in combination with covered socket (VM11, VM41)
- sockets are not part of the set
- SOFT 2M cover plate with inscription plate
- in accordance with IEC 60884-1



**SET ÇELËSASH PËR BANJË 3x20 A 250 V~ 4M**

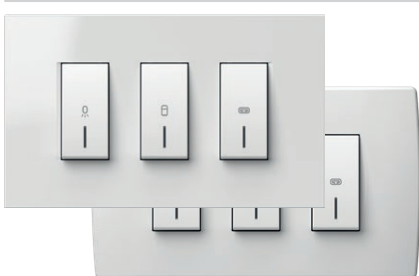

- CM25PWOL
- CM25IWOL
- CM25PWOS
- CM25IWOS

- set çelësash 3xSM12 20 A 250 V~ me kornizë montimi dhe kapak mbulues
- kontaktet e vidave 1,5-2,5mm<sup>2</sup>
- në përputhje me EN 60669-1
- zgjidhje universale për rinovimin e kutive me dimensione fikse 108-135 mm ose kuti madhësia 4M
- kapak mbulues lartësia 90 mm

**SWITCH SET FOR BATHROOM 3x20A 250V~ 4M**

- switch set 3xSM12 20A 250V~ with mounting frame and cover plate
- screw contacts 1.5-2.5mm<sup>2</sup>
- in accordance with EN 60669-1
- universal solution for renovation on boxes with fixing dimensions 108-135mm or boxes 4M size
- cover plate height 90mm

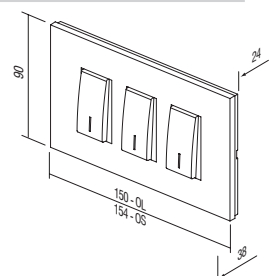



NM41

## SET KORNIZË MONTIMI PËR BANJË 4M

- kornizë montimi universale për set banje me vida
- zgjidhje universale për montimin në kutitë drejtkëndore me dimensione fikse 108-135 mm ose kuti madhësia 4M
- në përputhje me EN 60669-1

## MOUNTING FRAME BATHROOM SET 4M

- universal mounting frame for bathroom set with screws
- universal solution for mounting on rectangular boxes with fixing dimensions 108-135mm or boxes 4M size
- in accordance with EN 60669-1

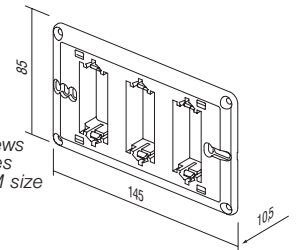

	OL41PW
	OL41MW
	OL41NB
	OL41IW
	OL41ES
	OL41SG
	OL41IB
	OL41AT
	OL41TI
	OL41SB

## SETI KAPAKU MBULUES LINE PËR BANJË

- set dekorativ kapaku mbulues për banjë LINE
- lartësia 90 mm
- në përputhje me EN 60669-1

## COVER PLATE LINE BATHROOM SET

- decorative cover plate bathroom set LINE
- height 90mm
- in accordance with EN 60669-1

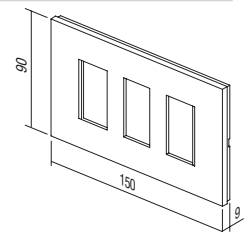

	OS41PW		OS41SB
	OS41MW		OS41WE
	OS41NB		OS41AT
	OS41IW		OS41TI
	OS41ES		
	OS41SG		

## SETI KAPAKU MBULUES SOFT PËR BANJË

- set dekorativ kapaku mbulues për banjë SOFT
- lartësia 90 mm
- në përputhje me EN 60669-1

## COVER PLATE SOFT BATHROOM SET

- decorative cover plate bathroom set SOFT
- height 90mm
- in accordance with EN 60669-1

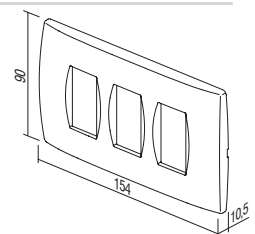



# PROGRAMI ANTIBAKTERIAL MODUL

Iloji type	përshkrimi description	madhësia size	ngjyra colour	të dhënat opsionale 1 optional data 1
TM11	BUTON BUTTON	1M	<input type="checkbox"/> AW e bardhë antibakteriale antibacterial white	NT neutral neutral
TM21	FALSO BLANK	1M		
VM10	PRIZË SOCKET	2M		IN treguesi indicator
.	.	.		
.	.	.		

## PROGRAMI ANTIBAKTERIAL MODUL

- çelësat dhe prizat preken çdo ditë nga shumë njerëz, prandaj janë një vend i zakonshëm për zhvillimin dhe përhapjen e baktereve
- falë karakteristikave të veta natyrale, argjendi është përdorur për tremijë vjet si dezinfektues i sigurt dhe efikas, duke qenë se është plotësisht natyral, i shëndetshëm dhe miqësor për mjedisin
- jonet speciale antibakteriale të argjendit ofrojnë mbrojtje afatgjatë, të qëndrueshme dhe efektive kundër zhvillimit dhe përhapjes së baktereve, mikrobeve dhe kërpudhave
- mbrojtja antibakteriale siguron higjienë, pastërti dhe shëndet për njerëzit
- programi antibakterial MODUL është plotësisht i përshtatshëm për përdorim në mjedise me kushte të rrepta higjienike (spitale, qendra shëndetësore, ambiente farmaceutike, azile pleqsh, laboratorë, restorante, hotele, aeroporte, stacione hekurudhore dhe autobusi, qendra biznesi dhe tregtare, institucione publike...)
- janë kryer testime të pavarura laboratorike në përputhje me standardet më të larta japoneze JIS Z 2801
- kosto e ulët për të siguruar shëndetin e njeriut
- dizajni dhe funksionimi i programit antibakterial MODUL lejon pastrim dhe mirëmbajtje të lehtë
- butonat antibakteriale, kapakët mbulues dhe prizat kombinohen me versione klasike të kornizave dhe çelësave
- produktet etiketohen në pjesën e pasme me AW (e bardhë antibakteriale)

## ANTIBACTERIAL PROGRAM MODUL

- switches and sockets are daily touched by many people, so this is a common place for development and spread of bacteria
- thanks to its natural antibacterial characteristics silver has been used for three millennia as a safe and effective disinfectant, since it is completely natural, healthy and environmentally friendly
- special antibacterial silver ions additive provides long-term, reliable and effective protection against the development and spread of bacteria, microbes and fungi
- antibacterial protection ensures hygiene, cleanliness and health for people
- perfectly suitable for use in environments with strict hygiene conditions (hospitals, health centers, pharmaceutical facilities, homes for elderly, nursing homes, laboratories, restaurants, hotels, airports, bus and railway stations, business and shopping areas, public institutions ...)
- independent laboratory testings have been carried out in accordance with highest Japanese standards JIS Z 2801
- low cost for providing human health
- design and functionality of antibacterial program MODUL allow easy cleaning and maintenance
- antibacterial buttons, cover plates and sockets are combined with classic mounting frames and switches
- products are labelled on the back with AW (antibacterial white)

## A N T I B A C T E R I A L P R O G R A M M O D U L

## BUTON 1M

 TM11AW

- buton i ndërrueshëm 1M
- në përputhje me EN 60669-1
- mbrojtje antibakteriale në përputhje me standardin JIS Z 2801

*BUTTON 1M*

- replaceable button 1M
- in accordance with EN 60669-1
- antibacterial protection in accordance with JIS Z 2801



## TREGUES BUTONI 1M

 TM11AWIN

- buton i ndërrueshëm 1M
- në përputhje me EN 60669-1
- mbrojtje antibakteriale në përputhje me standardin JIS Z 2801

*BUTTON 1M INDICATOR*

- replaceable button 1M
- in accordance with EN 60669-1
- antibacterial protection in accordance with JIS Z 2801



## BUTON 2M

 TM12AW

- buton i ndërrueshëm 2M me mbajtëse butoni
- për të përditësuar çelësin ose butonin me shtypje nga madhësia 1M në madhësinë 2M
- në përputhje me EN 60669-1
- mbrojtje antibakteriale në përputhje me standardin JIS Z 2801

*BUTTON 2M*

- replaceable button 2M with button carrier
- to upgrade switch or push button from size 1M to size 2M
- in accordance with EN 60669-1
- antibacterial protection in accordance with JIS Z 2801



## TREGUES BUTONI 2M

 TM12AWIN

- buton i ndërrueshëm 2M me mbajtëse butoni
- për të përditësuar çelësin ose butonin me shtypje nga madhësia 1M në madhësinë 2M
- në përputhje me EN 60669-1
- mbrojtje antibakteriale në përputhje me standardin JIS Z 2801

*BUTTON 2M INDICATOR*

- replaceable button 2M with button carrier
- to upgrade switch or push button from size 1M to size 2M
- in accordance with EN 60669-1
- antibacterial protection in accordance with JIS Z 2801



## FALSO 1M

 TM21AW

- modul falso për të mbushur hapësirat boshe
- në përputhje me EN 60669-1
- mbrojtje antibakteriale në përputhje me standardin JIS Z 2801

*BLANK 1M*

- blank modul to fill up empty spaces
- in accordance with EN 60669-1
- antibacterial protection in accordance with JIS Z 2801



## FALSO 2M

 TM22AW

- modul falso për të mbushur hapësirat boshe
- në përputhje me EN 60669-1
- mbrojtje antibakteriale në përputhje me standardin JIS Z 2801

*BLANK 2M*

- blank modul to fill up empty spaces
- in accordance with EN 60669-1
- antibacterial protection in accordance with JIS Z 2801





□ VM10AW

**PRIZË SCHUKO+KS 2P+E 16 A 250 V~ 2M**

- 2P+E schuko
- 16 A 250 V~, Iloji VM10
- në përputhje me IEC 60884-1, CEE7
- kontaktet e vidave 1,5-2,5 mm<sup>2</sup>
- mbrojtje e integruar kontakti
- mbrojtje antibakteriale në përputhje me standardin JIS Z 2801

**SOCKET SCHUKO+KS 2P+E 16A 250V~ 2M**

- 2P+E schuko
- 16A 250V~, type VM10
- in accordance with IEC 60884-1, CEE7
- screw contacts 1.5-2.5 mm<sup>2</sup>
- built-in contact protection
- antibacterial protection in accordance with JIS Z 2801



□ VM11AW

**PRIZË SCHUKO+KS+KAPAK 2P+E 16 A 250 V~ 2M**

- 2P+E schuko+kapak
- 16 A 250 V~, Iloji VM11
- në përputhje me IEC 60884-1, CEE7
- kontaktet e vidave 1,5-2,5 mm<sup>2</sup>
- mbrojtje e integruar kontakti
- mbrojtje antibakteriale në përputhje me standardin JIS Z 2801

**SOCKET SCHUKO+KS+COVER**

- 2P+E 16A 250V~ 2M
- 2P+E schuko+cover
- 16A 250V~, type VM11
- in accordance with IEC 60884-1, CEE7
- screw contacts 1.5-2.5 mm<sup>2</sup>
- built-in contact protection
- antibacterial protection in accordance with JIS Z 2801



□ VM20AW

**PRIZË EURO+KS 2P 10A 250 V~ 1M**

- 2P Euro
- 10A 250 V~, Iloji VM20
- në përputhje me IEC 60884-1, CEE7
- kontaktet e vidave 1,5-2,5 mm<sup>2</sup>
- mbrojtje e integruar kontakti
- mbrojtje antibakteriale në përputhje me standardin JIS Z 2801

**SOCKET EURO+KS 2P 10A 250V~ 1M**

- 2P Euro
- 10A 250V~, type VM20
- in accordance with IEC 60884-1, CEE7
- screw contacts 1.5-2.5 mm<sup>2</sup>
- built-in contact protection
- antibacterial protection in accordance with JIS Z 2801



□ KM11AW

**PRIZË TV ME KAPAK FUNDOR 1dB 1M**

- TV me kapak fundor
- gama e frekuencës 5÷2400 MHz
- reduktimi < 1 dB
- në përputhje me EN 50083-1
- kontaktet e vidave
- mbrojtje antibakteriale në përputhje me standardin JIS Z 2801

**SOCKET TV END-LINE 1dB 1M**

- TV end-line
- frequency range 5÷2400 MHz
- reduction < 1 dB
- in accordance with EN 50083-1
- screw contacts
- antibacterial protection in accordance with JIS Z 2801

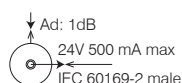

□ KM35AW

**PËRSHTATËS KS 1M**

- standard fiksues trapez KS
- AMP, Avaya, Brandrex, FMT, Mfico, Tyco, ...
- moduli i komunikimit nuk përfshihet
- mbrojtje antibakteriale në përputhje me standardin JIS Z 2801

**ADAPTER KS 1M**

- KS keystone fixing standard
- AMP, Avaya, Brandrex, FMT, Mfico, Tyco, ...
- communication module not included
- antibacterial protection in accordance with JIS Z 2801

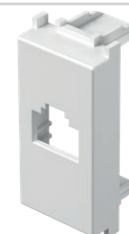





OS20AW

#### KAPAK MBULUES SOFT 2M

- kapak mbulues dekorativ SOFT 2M
- në përputhje me EN 60669-1
- mbrojtje antibakteriale në përputhje me standardin JIS Z 2801

#### COVER PLATE SOFT 2M

- decorative cover plate SOFT 2M
- in accordance with EN 60669-1
- antibacterial protection in accordance with JIS Z 2801



OS24AW

#### KAPAK MBULUES SOFT 2x2M

- kapak mbulues dekorativ SOFT 2x2M
- montim horizontal ose vertikal
- në përputhje me EN 60669-1
- mbrojtje antibakteriale në përputhje me standardin JIS Z 2801

#### COVER PLATE SOFT 2x2M

- decorative cover plate SOFT 2x2M
- horizontal or vertical mounting
- in accordance with EN 60669-1
- antibacterial protection in accordance with JIS Z 2801



OS26AW

#### KAPAK MBULUES SOFT 3x2M

- kapak mbulues dekorativ SOFT 3x2M
- montim horizontal ose vertikal
- në përputhje me EN 60669-1
- mbrojtje antibakteriale në përputhje me standardin JIS Z 2801

#### COVER PLATE SOFT 3x2M

- decorative cover plate SOFT 3x2M
- horizontal or vertical mounting
- in accordance with EN 60669-1
- antibacterial protection in accordance with JIS Z 2801

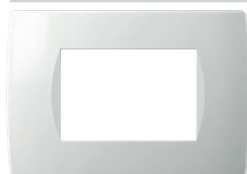

OS30AW

#### KAPAK MBULUES SOFT 3M

- kapak mbulues dekorativ SOFT 3M
- në përputhje me EN 60669-1
- mbrojtje antibakteriale në përputhje me standardin JIS Z 2801

#### COVER PLATE SOFT 3M

- decorative cover plate SOFT 3M
- in accordance with EN 60669-1
- antibacterial protection in accordance with JIS Z 2801



OS40AW

#### KAPAK MBULUES SOFT 4M

- kapak mbulues dekorativ SOFT 4M
- në përputhje me EN 60669-1
- mbrojtje antibakteriale në përputhje me standardin JIS Z 2801

#### COVER PLATE SOFT 4M

- decorative cover plate SOFT 4M
- in accordance with EN 60669-1
- antibacterial protection in accordance with JIS Z 2801

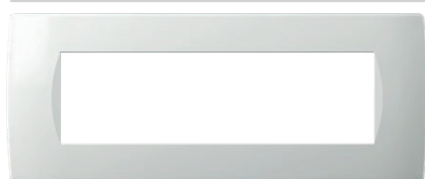

OS70AW

#### KAPAK MBULUES SOFT 7M

- kapak mbulues dekorativ SOFT 7M
- në përputhje me EN 60669-1
- mbrojtje antibakteriale në përputhje me standardin JIS Z 2801

#### COVER PLATE SOFT 7M

- decorative cover plate SOFT 7M
- in accordance with EN 60669-1
- antibacterial protection in accordance with JIS Z 2801

bazë  
basic

PW e bardhë polare  
polar white

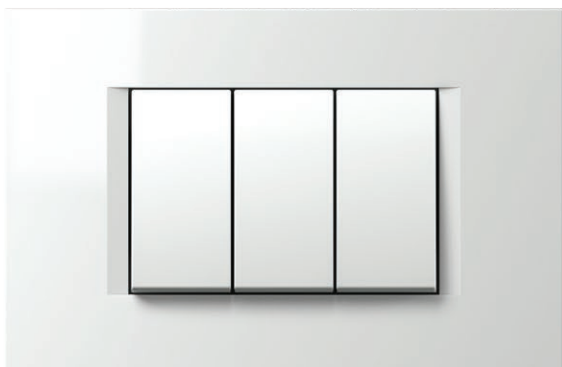

IW e bardhë fildishi  
ivory white

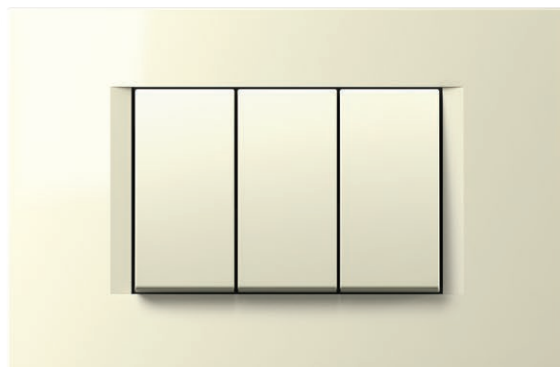

ES e argjendtë elox  
elox silver



SB e zezë soft touch  
soft touch black



AT antracit  
anthracite

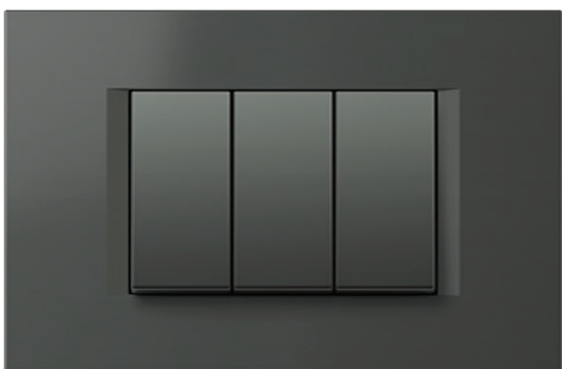

MW e bardhë mat  
matte white

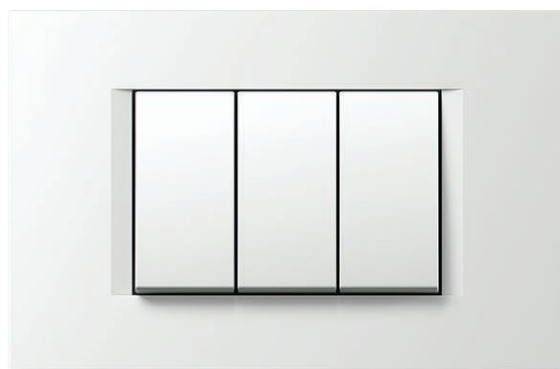

## COVER PLATES LINE OL

dekor  
decor

SG e artë ranore  
sand gold

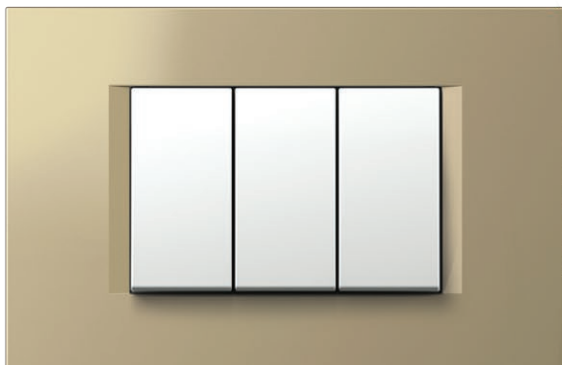

NB e zezë mesnate  
night black

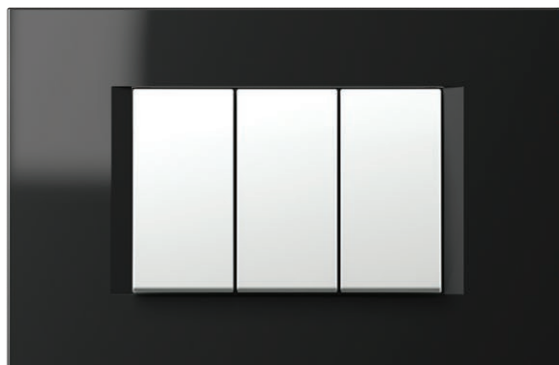

IB Impuls blu  
impulse blue

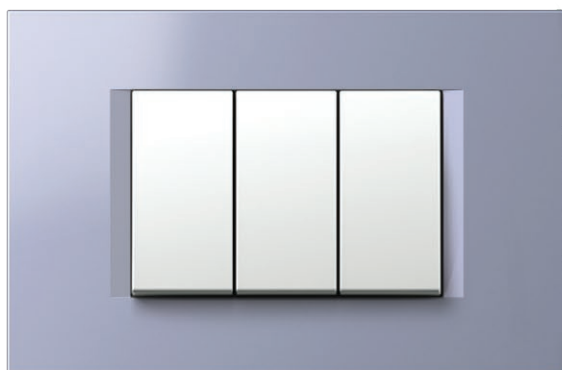

TI titan  
titanium



SW e bardhë guri  
stone white





# KAPAK ËT MBULUES LINE OL

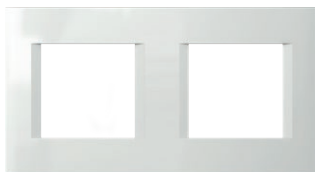

OL30

PW

lloji type	përshkrimi description	madhësia size	ngjyra colour												
OL10	KAPAK MBULUES LINE COVER PLATE LINE	1/2M	<table border="0"> <tr> <td></td> <td>PW e bardhë polare polar white</td> <td></td> <td>SG e artë ranore sand gold</td> <td></td> <td>AT antracit anthracite</td> </tr> </table>		PW e bardhë polare polar white		SG e artë ranore sand gold		AT antracit anthracite						
	PW e bardhë polare polar white		SG e artë ranore sand gold		AT antracit anthracite										
OL13	KAPAK MBULUES LINE COVER PLATE LINE	1/3M	<table border="0"> <tr> <td></td> <td>MW e bardhë mat matte white</td> <td></td> <td>NB e zezë mesnate night black</td> <td></td> <td>TI titan titanium</td> </tr> </table>		MW e bardhë mat matte white		NB e zezë mesnate night black		TI titan titanium						
	MW e bardhë mat matte white		NB e zezë mesnate night black		TI titan titanium										
OL20	KAPAK MBULUES LINE COVER PLATE LINE	2M	<table border="0"> <tr> <td></td> <td>IW e bardhë fildishi ivory white</td> <td></td> <td>IB Impuls blu impulse blue</td> <td></td> <td>SW e bardhë guri stone white</td> </tr> <tr> <td></td> <td>ES e argjendtë elox elox silver</td> <td></td> <td>SB e zezë soft touch soft touch black</td> <td></td> <td></td> </tr> </table>		IW e bardhë fildishi ivory white		IB Impuls blu impulse blue		SW e bardhë guri stone white		ES e argjendtë elox elox silver		SB e zezë soft touch soft touch black		
	IW e bardhë fildishi ivory white		IB Impuls blu impulse blue		SW e bardhë guri stone white										
	ES e argjendtë elox elox silver		SB e zezë soft touch soft touch black												



	OL10PW		OL10SG
	OL10MW		OL10NB
	OL10IW		OL10IB
	OL10ES		OL10AT
	OL10SB		OL10TI
			OL10SW

## KAPAK MBULUES LINE 1/2M

- kapak mbulues dekorativ LINE 1/2M  
- në përputhje me EN 60669-1

### COVER PLATE LINE 1/2M

- decorative cover plate LINE 1/2M  
- in accordance with EN 60669-1

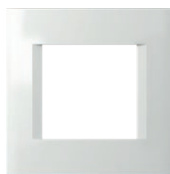

	OL20PW		OL20SG
	OL20MW		OL20NB
	OL20IW		OL20IB
	OL20ES		OL20AT
	OL20SB		OL20TI
			OL20SW

## KAPAK MBULUES LINE 2M

- kapak mbulues dekorativ LINE 2M  
- në përputhje me EN 60669-1

### COVER PLATE LINE 2M

- decorative cover plate LINE 2M  
- in accordance with EN 60669-1

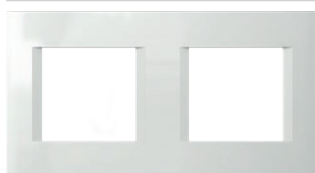

	OL24PW		OL24SG
	OL24MW		OL24NB
	OL24IW		OL24IB
	OL24ES		OL24AT
	OL24SB		OL24TI
			OL24SW

## KAPAK MBULUES LINE 2x2M

- kapak mbulues dekorativ LINE 2x2M  
- montim horizontal ose vertikal  
- në përputhje me EN 60669-1

### COVER PLATE LINE 2x2M

- decorative cover plate LINE 2x2M  
- horizontal or vertical mounting  
- in accordance with EN 60669-1



	OL26PW		OL26SG
	OL26MW		OL26NB
	OL26IW		OL26IB
	OL26ES		OL26AT
	OL26SB		OL26TI
			OL26SW

## KAPAK MBULUES LINE 3x2M

- kapak mbulues dekorativ LINE 3x2M  
- montim horizontal ose vertikal  
- në përputhje me EN 60669-1

### COVER PLATE LINE 3x2M

- decorative cover plate LINE 3x2M  
- horizontal or vertical mounting  
- in accordance with EN 60669-1



	OL28PW		OL28SG
	OL28MW		OL28NB
	OL28IW		OL28IB
	OL28ES		OL28AT
	OL28SB		OL28TI
			OL28SW

## KAPAK MBULUES LINE 4x2M

- kapak mbulues dekorativ LINE 4x2M  
- montim horizontal ose vertikal  
- në përputhje me EN 60669-1

### COVER PLATE LINE 4x2M

- decorative cover plate LINE 4x2M  
- horizontal or vertical mounting  
- in accordance with EN 60669-1

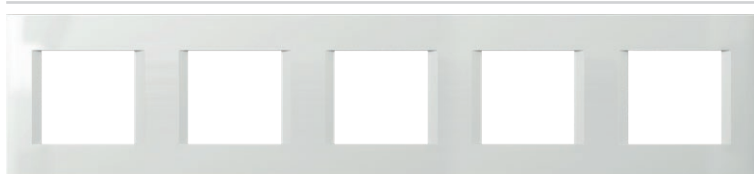

	OL29PW
	OL29MW
	OL29IW
	OL29ES
	OL29SB
	OL29AT
	OL29TI

## KAPAK MBULUES LINE 5x2M









- kapak mbulues dekorativ LINE 5x2M  
- montim horizontal ose vertikal  
- në përputhje me EN 60669-1

### COVER PLATE LINE 5x2M

- decorative cover plate LINE 5x2M  
- horizontal or vertical mounting  
- in accordance with EN 60669-1

## COVER PLATES LINE OL



 OL13PW	 OL13SG
 OL13MW	 OL13NB
 OL13IW	 OL13IB
 OL13ES	 OL13AT
 OL13SB	 OL13TI
	 OL13SW







## KAPAK MBULUES LINE 1/3M

- kapak mbulues dekorativ LINE 1/3M  
- në përputhje me EN 60669-1

## COVER PLATE LINE 1/3M

- decorative cover plate LINE 1/3M  
- in accordance with EN 60669-1



 OL30PW	 OL30SG
 OL30MW	 OL30NB
 OL30IW	 OL30IB
 OL30ES	 OL30AT
 OL30SB	 OL30TI
	 OL30SW









## KAPAK MBULUES LINE 3M

- kapak mbulues dekorativ LINE 3M  
- në përputhje me EN 60669-1

## COVER PLATE LINE 3M

- decorative cover plate LINE 3M  
- in accordance with EN 60669-1



 OL40PW	 OL40SG
 OL40MW	 OL40NB
 OL40IW	 OL40IB
 OL40ES	 OL40AT
 OL40SB	 OL40TI
	 OL40SW







## KAPAK MBULUES LINE 4M

- kapak mbulues dekorativ LINE 4M  
- në përputhje me EN 60669-1

## COVER PLATE LINE 4M

- decorative cover plate LINE 4M  
- in accordance with EN 60669-1



 OL70PW	 OL70SG
 OL70MW	 OL70NB
 OL70IW	 OL70IB
 OL70ES	 OL70AT
 OL70SB	 OL70TI
	 OL70SW







## KAPAK MBULUES LINE 7M

- kapak mbulues dekorativ LINE 7M  
- në përputhje me EN 60669-1

## COVER PLATE LINE 7M

- decorative cover plate LINE 7M  
- in accordance with EN 60669-1



 OL71PW	 OL71AT
 OL71MW	 OL71TI
 OL71IW	
 OL71ES	
 OL71SB	









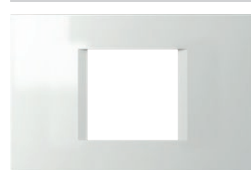

## KAPAK MBULUES LINE 2x7M

- kapak mbulues dekorativ LINE 2x7M  
- në përputhje me EN 60669-1

## COVER PLATE LINE 2x7M

- decorative cover plate LINE 2x7M  
- in accordance with EN 60669-1



 OL23PW	 OL23SG
 OL23MW	 OL23NB
 OL23IW	 OL23IB
 OL23ES	 OL23AT
 OL23SB	 OL23TI
	 OL23SW

## KAPAK MBULUES LINE 2/3M

- kapak mbulues dekorativ LINE 2/3M  
- në përputhje me EN 60669-1

## COVER PLATE LINE 2/3M

- decorative cover plate LINE 2/3M  
- in accordance with EN 60669-1

bazë  
basic

PW e bardhë polare  
polar white

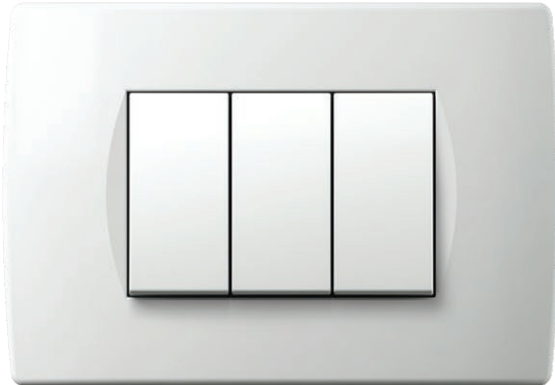

IW e bardhë fildishi  
ivory white

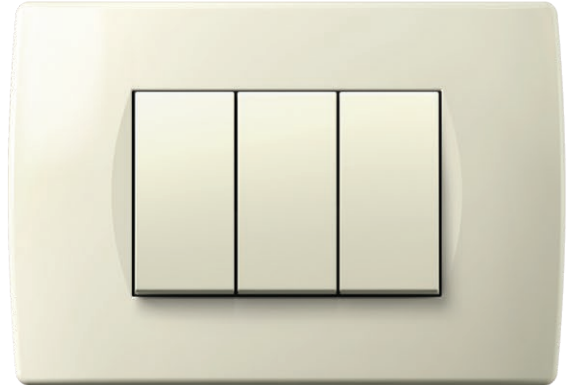

ES e argjendtë elox  
elox silver

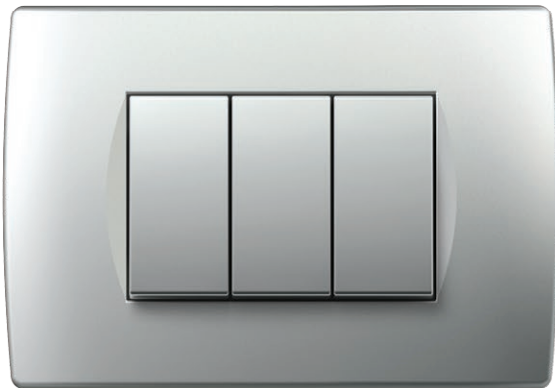

SB e zezë soft touch  
soft touch black



AT antracit  
anthracite



MW e bardhë mat  
matte white

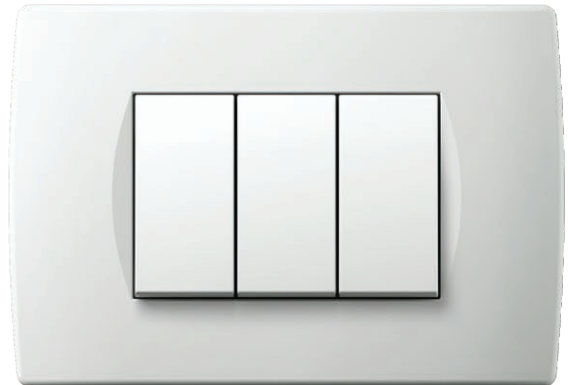

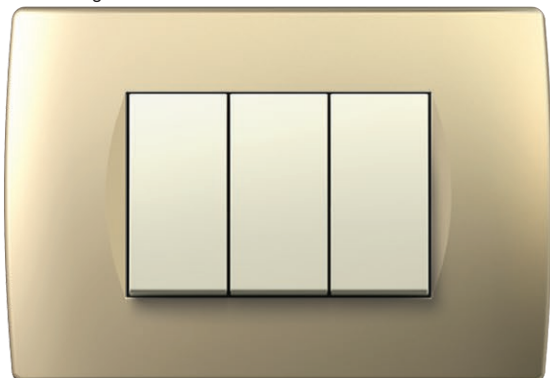
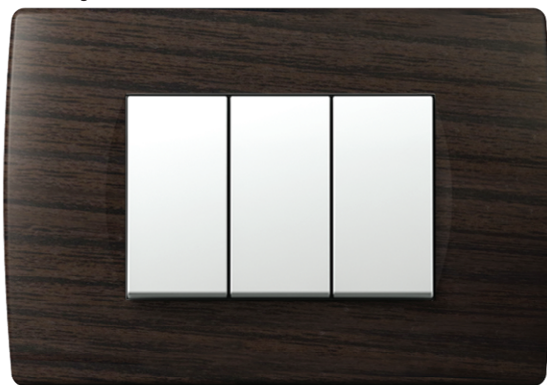

## COVER PLATES SOFT OS

dekor  
decorSG e artë ranore  
sand goldNB e zezë mesnate  
night blackTI titan  
titaniumWE venge  
wengeWW arrë  
walnut

# K A P A K Ë T M B U L U E S S O F T O S



OS30



PW

lloji type	përshkrimi description	madhësia size	ngjyra colour																		
OS10	KAPAK MBULUES SOFT COVER PLATE SOFT	1/2M	<table border="0"> <tr> <td></td> <td>PW e bardhë polare polar white</td> <td></td> <td>SG e artë ranore sand gold</td> <td></td> <td>WW arrë walnut</td> </tr> </table>		PW e bardhë polare polar white		SG e artë ranore sand gold		WW arrë walnut												
	PW e bardhë polare polar white		SG e artë ranore sand gold		WW arrë walnut																
OS13	KAPAK MBULUES SOFT COVER PLATE SOFT	1/3M	<table border="0"> <tr> <td></td> <td>MW e bardhë mat matte white</td> <td></td> <td>NB e zezë mesnate night black</td> <td></td> <td>WE venge wenge</td> </tr> </table>		MW e bardhë mat matte white		NB e zezë mesnate night black		WE venge wenge												
	MW e bardhë mat matte white		NB e zezë mesnate night black		WE venge wenge																
OS20	KAPAK MBULUES SOFT COVER PLATE SOFT	2M	<table border="0"> <tr> <td></td> <td>IW e bardhë fildishi ivory white</td> <td></td> <td>AT antracit anthracite</td> <td></td> <td></td> </tr> <tr> <td></td> <td>ES e argjendtë elox elox silver</td> <td></td> <td>TI titan titanium</td> <td></td> <td></td> </tr> <tr> <td></td> <td>SB e zezë soft touch soft touch black</td> <td></td> <td></td> <td></td> <td></td> </tr> </table>		IW e bardhë fildishi ivory white		AT antracit anthracite				ES e argjendtë elox elox silver		TI titan titanium				SB e zezë soft touch soft touch black				
	IW e bardhë fildishi ivory white		AT antracit anthracite																		
	ES e argjendtë elox elox silver		TI titan titanium																		
	SB e zezë soft touch soft touch black																				
.	.	.	.																		
.	.	.	.																		



	OS10PW		OS10SG
	OS10MW		OS10NB
	OS10IW		OS10AT
	OS10ES		OS10TI
	OS10SB		OS10WW
			OS10WE

## KAPAK MBULUES SOFT 1/2M

- kapak mbulues dekorativ SOFT 1/2M  
- në përputhje me EN 60669-1

### COVER PLATE SOFT 1/2M

- decorative cover plate SOFT 1/2M  
- in accordance with EN 60669-1



	OS20PW		OS20SG
	OS20MW		OS20NB
	OS20IW		OS20AT
	OS20ES		OS20TI
	OS20SB		OS20WW
			OS20WE

## KAPAK MBULUES SOFT 2M

- kapak mbulues dekorativ SOFT 2M  
- në përputhje me EN 60669-1

### COVER PLATE SOFT 2M

- decorative cover plate SOFT 2M  
- in accordance with EN 60669-1



	OS24PW		OS24SG
	OS24MW		OS24NB
	OS24IW		OS24AT
	OS24ES		OS24TI
	OS24SB		OS24WW
			OS24WE

## KAPAK MBULUES SOFT 2x2M

- kapak mbulues dekorativ SOFT 2x2M  
- montim horizontal ose vertikal  
- në përputhje me EN 60669-1

### COVER PLATE SOFT 2x2M

- decorative cover plate SOFT 2x2M  
- horizontal or vertical mounting  
- in accordance with EN 60669-1

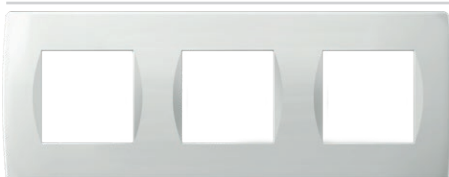

	OS26PW		OS26SG
	OS26MW		OS26NB
	OS26IW		OS26AT
	OS26ES		OS26TI
	OS26SB		OS26WW
			OS26WE

## KAPAK MBULUES SOFT 3x2M

- kapak mbulues dekorativ SOFT 3x2M  
- montim horizontal ose vertikal  
- në përputhje me EN 60669-1

### COVER PLATE SOFT 3x2M

- decorative cover plate SOFT 3x2M  
- horizontal or vertical mounting  
- in accordance with EN 60669-1



	OS28PW		OS28SG
	OS28MW		OS28NB
	OS28IW		OS28AT
	OS28ES		OS28TI
	OS28SB		OS28WW
			OS28WE

## KAPAK MBULUES SOFT 4x2M

- kapak mbulues dekorativ SOFT 4x2M  
- montim horizontal ose vertikal  
- në përputhje me EN 60669-1

### COVER PLATE SOFT 4x2M

- decorative cover plate SOFT 4x2M  
- horizontal or vertical mounting  
- in accordance with EN 60669-1

## COVER PLATES SOFT OS



 OS13PW	 OS13SG
 OS13MW	 OS13NB
 OS13IW	 OS13AT
 OS13ES	 OS13TI
 OS13SB	 OS13WW
	 OS13WE

## KAPAK MBULUES SOFT 1/3M

- kapak mbulues dekorativ SOFT 1/3M  
- në përputhje me EN 60669-1

## COVER PLATE SOFT 1/3M

- decorative cover plate SOFT 1/3M  
- in accordance with EN 60669-1



 OS30PW	 OS30SG
 OS30MW	 OS30NB
 OS30IW	 OS30AT
 OS30ES	 OS30TI
 OS30SB	 OS30WW
	 OS30WE

## KAPAK MBULUES SOFT 3M

- kapak mbulues dekorativ SOFT 3M  
- në përputhje me EN 60669-1

## COVER PLATE SOFT 3M

- decorative cover plate SOFT 3M  
- in accordance with EN 60669-1



 OS40PW	 OS40SG
 OS40MW	 OS40NB
 OS40IW	 OS40AT
 OS40ES	 OS40TI
 OS40SB	 OS40WW
	 OS40WE

## KAPAK MBULUES SOFT 4M

- kapak mbulues dekorativ SOFT 4M  
- në përputhje me EN 60669-1

## COVER PLATE SOFT 4M

- decorative cover plate SOFT 4M  
- in accordance with EN 60669-1

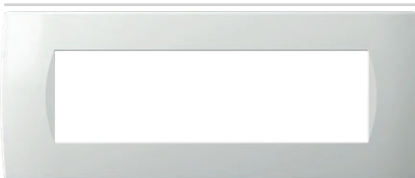

 OS70PW	 OS70SG
 OS70MW	 OS70NB
 OS70IW	 OS70AT
 OS70ES	 OS70TI
 OS70SB	 OS70WW
	 OS70WE







## KAPAK MBULUES SOFT 7M

- kapak mbulues dekorativ SOFT 7M  
- në përputhje me EN 60669-1

## COVER PLATE SOFT 7M

- decorative cover plate SOFT 7M  
- in accordance with EN 60669-1



 OS71PW	 OS71AT
 OS71MW	 OS71TI
 OS71IW	
 OS71ES	
 OS71SB	







## KAPAK MBULUES SOFT 2x7M

- kapak mbulues dekorativ SOFT 7x2M  
- në përputhje me EN 60669-1

## COVER PLATE SOFT 2x7M

- decorative cover plate SOFT 2x7M  
- in accordance with EN 60669-1



 OS72PW	 OS72SG
 OS72IW	 OS72AT
 OS72ES	 OS72TI
 OS72SB	

## KAPAK MBULUES SOFT 2x7M

- kapak mbulues dekorativ SOFT 7x2M  
me pllakë me mbishkrim  
- në përputhje me EN 60669-1

## COVER PLATE SOFT 2x7M

- decorative cover plate SOFT 2x7M  
with inscription plate  
- in accordance with EN 60669-1

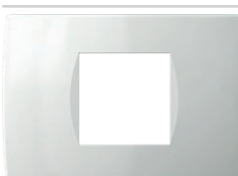

 OS23PW	 OS23SG
 OS23MW	 OS23NB
 OS23IW	 OS23AT
 OS23ES	 OS23TI
 OS23SB	 OS23WW
	 OS23WE

## KAPAK MBULUES SOFT 2/3M

- kapak mbulues dekorativ SOFT 2/3M  
- në përputhje me EN 60669-1

## COVER PLATE SOFT 2/3M

- decorative cover plate SOFT 2/3M  
- in accordance with EN 60669-1



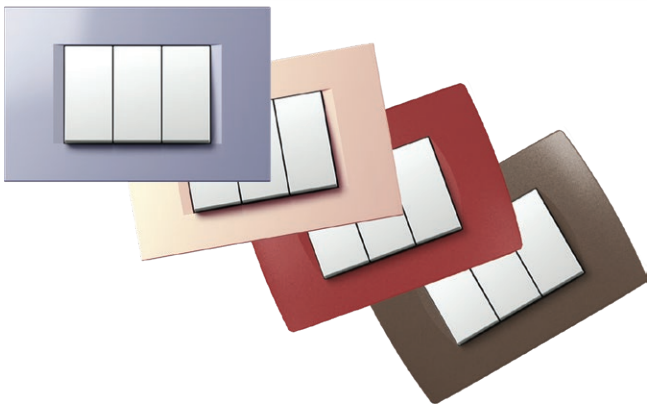

#### ZBUKURIMET E KAPAKËVE MBULUES

- kur porosisni sasi të mëdha, kapakët mbulues mund të bëhen në ngjyrën që ju zgjidhni
- i përshtatshëm për kapakët mbulues OL, OS

#### *COVER PLATES DECORATIONS*

- when ordering large quantities, cover plates can be made in the colour of your choice
- suitable for cover plates OL, OS



dru  
wood

WB bambu  
bamboo



WW arrë  
walnut



WM panjë  
maple



WE venge  
wenge



**Natyra është unike dhe e çmuar, sepse kapakët tanë mbulues dekorativë nuk janë dy njësoj.**  
*Nuk mund të konsiderohen ankesat rreth pamjes diverse dhe ndryshimeve të kapakëve dekorativë prej druri.*

**Nature is unique and precious, as our decorative cover plates where no two are the same.**  
*Complaints about wooden decorative cover plate's diverse appearance and differentiation cannot be considered.*

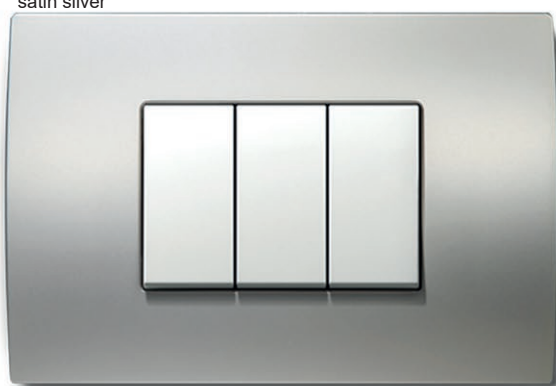
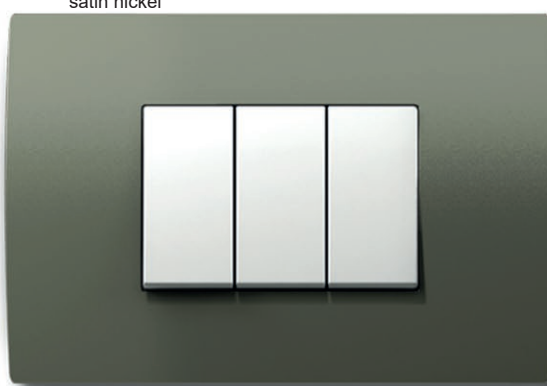
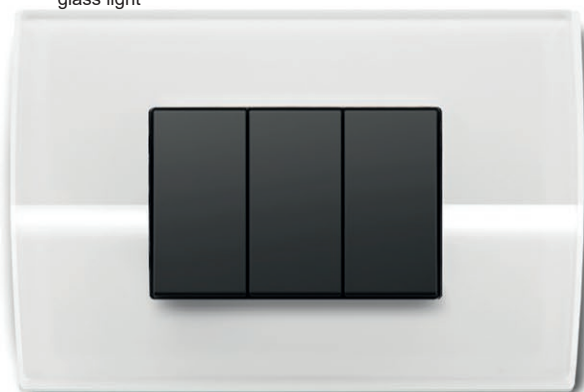
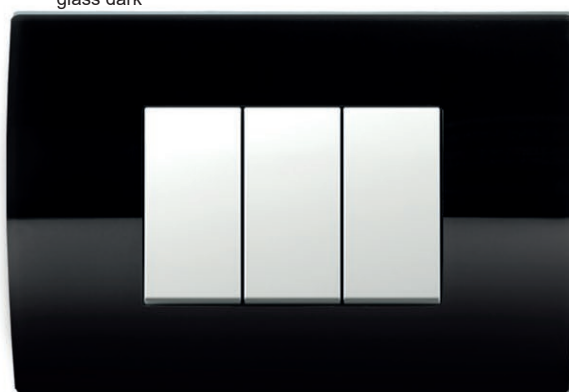

## C O V E R P L A T E S P U R E O P

metal  
metalMH çelik i rrahur  
hammered steelME hekur i ngrënë  
etched ironMS argjend satin  
satin silverMN nikel satin  
satin nickelxham  
glassGL e bardhë  
glass lightGD e zezë  
glass dark



OP30

WB

lloji type	përshkrimi description	madhësia size	ngjyra colour					
OP13	KAPAK MBULUES PURE COVER PLATE PURE	1/3M	MH	çelik i rrahur hammered steel	WB	bambu bamboo	GL	e bardhë glass light
OP20	KAPAK MBULUES PURE COVER PLATE PURE	2M	ME	hekur i ngrënë etched iron	WW	arrë walnut	GD	e zezë glass dark
OP23	KAPAK MBULUES PURE COVER PLATE PURE	2/3M	MS	argjend satin satin silver	WM	panjë maple		
.	.	.	MN	nikel satin satin nickel	WE	venge wenge		



OP20MH	OP20WB
OP20ME	OP20WW
OP20MS	OP20WM
OP20MN	OP20GL
	OP20GD

KAPAK MBULUES PURE 2M

- kapak mbulues dekorativ PURE 2M
- në përputhje me EN 60669-1
- vetëm në kombinim me kornizë montimi NM24 ose NM25

COVER PLATE PURE 2M

- decorative cover plate PURE 2M
- in accordance with EN 60669-1



OP24MH	OP24WB
OP24ME	OP24WW
OP24MS	OP24WM
OP24MN	OP24GL
	OP24GD

KAPAK MBULUES PURE 2x2M

- kapak mbulues dekorativ PURE 2x2M
- montim horizontal ose vertikal
- në përputhje me EN 60669-1
- vetëm në kombinim me kornizë montimi NM24 ose NM25

COVER PLATE PURE 2x2M

- decorative cover plate PURE 2x2M
- horizontal or vertical mounting
- in accordance with EN 60669-1

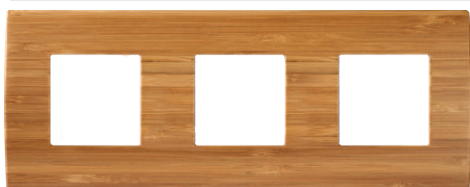

OP26MH	OP26WB
OP26ME	OP26WW
OP26MS	OP26WM
OP26MN	OP26GL
	OP26GD

KAPAK MBULUES PURE 3x2M

- kapak mbulues dekorativ PURE 3x2M
- montim horizontal ose vertikal
- në përputhje me EN 60669-1
- vetëm në kombinim me kornizë montimi NM24 ose NM25

COVER PLATE PURE 3x2M

- decorative cover plate PURE 3x2M
- horizontal or vertical mounting
- in accordance with EN 60669-1



OP28MH	OP28WB
OP28ME	OP28WW
OP28MS	OP28WM
OP28MN	OP28GL
	OP28GD

KAPAK MBULUES PURE 4x2M

- kapak mbulues dekorativ PURE 4x2M
- montim horizontal ose vertikal
- në përputhje me EN 60669-1
- vetëm në kombinim me kornizë montimi NM24 ose NM25

COVER PLATE PURE 4x2M

- decorative cover plate PURE 4x2M
- horizontal or vertical mounting
- in accordance with EN 60669-1

MODUL

PURE

## C O V E R P L A T E S P U R E O P



	OP13MH		OP13WB
	OP13ME		OP13WW
	OP13MS		OP13WM
	OP13MN		OP13WE
			OP13GL
			OP13GD

## KAPAK MBULUES PURE 1/3M

- kapak mbulues dekorativ PURE 1/3M  
- në përputhje me EN 60669-1

## COVER PLATE PURE 1/3M

- decorative cover plate PURE 1/3M  
- in accordance with EN 60669-1



	OP30MH		OP30WB
	OP30ME		OP30WW
	OP30MS		OP30WM
	OP30MN		OP30WE
			OP30GL
			OP30GD

## KAPAK MBULUES PURE 3M

- kapak mbulues dekorativ PURE 3M  
- në përputhje me EN 60669-1

## COVER PLATE PURE 3M

- decorative cover plate PURE 3M  
- in accordance with EN 60669-1



	OP40MH		OP40WB
	OP40ME		OP40WW
	OP40MS		OP40WM
	OP40MN		OP40WE
			OP40GL
			OP40GD

## KAPAK MBULUES PURE 4M

- kapak mbulues dekorativ PURE 4M  
- në përputhje me EN 60669-1

## COVER PLATE PURE 4M

- decorative cover plate PURE 4M  
- in accordance with EN 60669-1



	OP70MH		OP70WB
	OP70ME		OP70WW
	OP70MS		OP70WM
	OP70MN		OP70WE
			OP70GL
			OP70GD

## KAPAK MBULUES PURE 7M

- kapak mbulues dekorativ PURE 7M  
- në përputhje me EN 60669-1

## COVER PLATE PURE 7M

- decorative cover plate PURE 7M  
- in accordance with EN 60669-1



	OP23MH		OP23WB
	OP23ME		OP23WW
	OP23MS		OP23WM
	OP23MN		OP23WE
			OP23GL
			OP23GD

## KAPAK MBULUES PURE 2/3M

- kapak mbulues dekorativ PURE 2/3M  
- në përputhje me EN 60669-1

## COVER PLATE PURE 2/3M

- decorative cover plate PURE 2/3M  
- in accordance with EN 60669-1



Be bold, be EDGE

## C O V E R P L A T E S E D G E O G

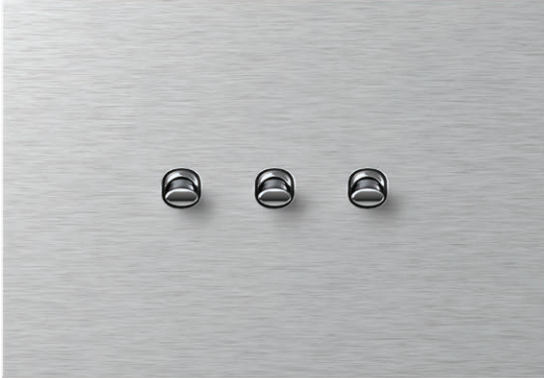
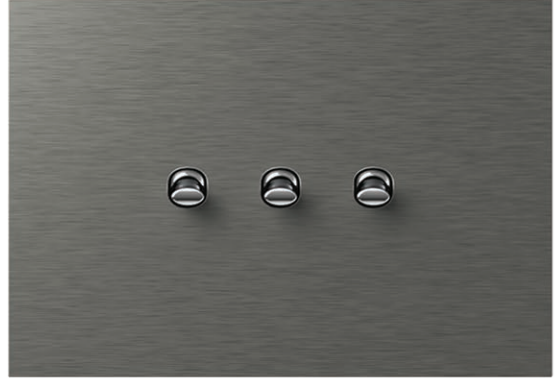
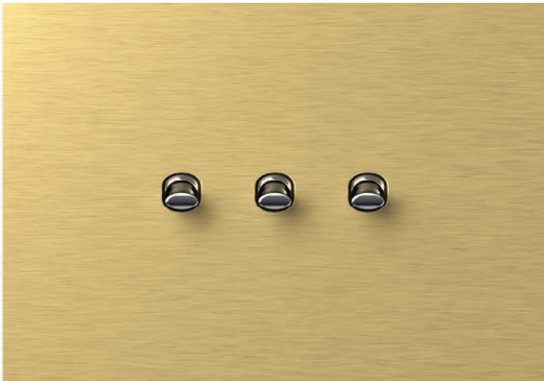
metal  
metalMA e argjendtë  
silverMT antracit  
anthraciteMZ e artë  
goldxham  
glassGD xham i errët  
glass darkGL xham i çelur  
glass light



# K A P A K Ë T M B U L U E S E D G E O G

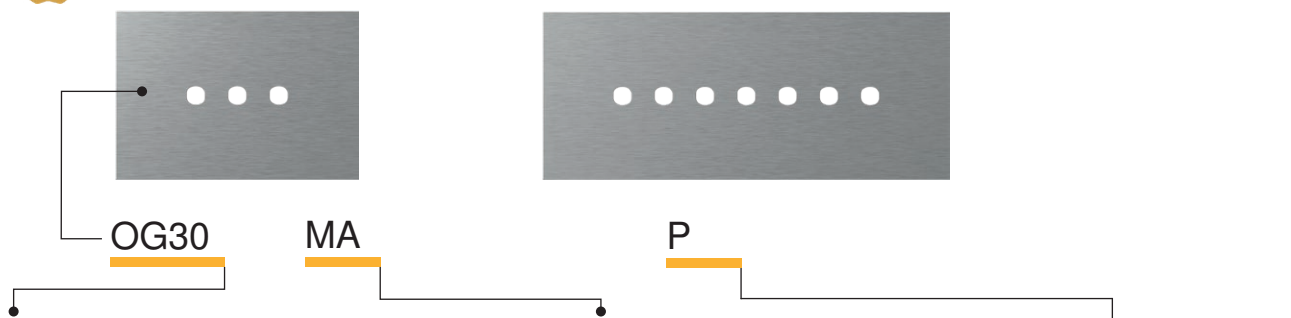

lloji type	përshkrimi description	madhësia size	ngjyra colour
OG10	KAPAK MBULUES EDGE COVER PLATE EDGE	1/2M	MA e argjendtë silver
OG13	KAPAK MBULUES EDGE COVER PLATE EDGE	1/3M	MT antracit anthracite
OG20	KAPAK MBULUES EDGE COVER PLATE EDGE	2M	MZ e artë gold
:	:	:	

GD xham i errët  
glass dark  
 GL xham i çelur  
glass light

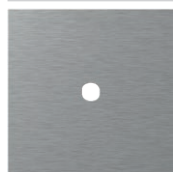
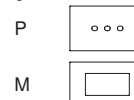

OG10MAP  
 OG10MTP  
 OG10MZP

OG10GDP  
 OG10GLP

## KAPAK MBULUES EDGE 1/2M

- kapak mbulues dekorativ EDGE 1/2M  
- në përputhje me EN 60669-1

### COVER PLATE EDGE 1/2M

- decorative cover plate EDGE 1/2M  
- in accordance with EN 60669-1

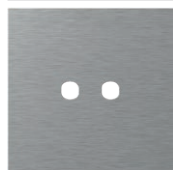

OG20MAP  
 OG20MTP  
 OG20MZP

OG20GDP  
 OG20GLP

## KAPAK MBULUES EDGE 2M

- kapak mbulues dekorativ EDGE 2M  
- në përputhje me EN 60669-1

### COVER PLATE EDGE 2M

- decorative cover plate EDGE 2M  
- in accordance with EN 60669-1



## C O V E R P L A T E S E D G E O G

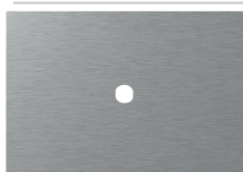

## KAPAK MBULUES EDGE 1/3M

- kapak mbulues dekorativ EDGE 1/3M  
- në përputhje me EN 60669-1

## COVER PLATE EDGE 1/3M

- decorative cover plate EDGE 1/3M  
- in accordance with EN 60669-1

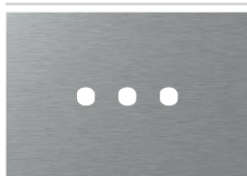

## KAPAK MBULUES EDGE 3M

- kapak mbulues dekorativ EDGE 3M  
- në përputhje me EN 60669-1

## COVER PLATE EDGE 3M

- decorative cover plate EDGE 3M  
- in accordance with EN 60669-1

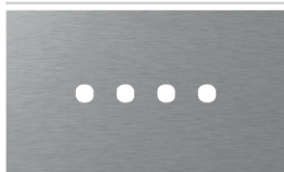

## KAPAK MBULUES EDGE 4M

- kapak mbulues dekorativ EDGE 4M  
- në përputhje me EN 60669-1

## COVER PLATE EDGE 4M

- decorative cover plate EDGE 4M  
- in accordance with EN 60669-1

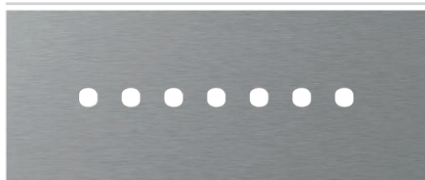

## KAPAK MBULUES EDGE 7M

- kapak mbulues dekorativ EDGE 7M  
- në përputhje me EN 60669-1

## COVER PLATE EDGE 7M

- decorative cover plate EDGE 7M  
- in accordance with EN 60669-1

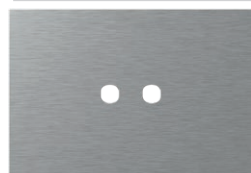

## KAPAK MBULUES EDGE 2/3M

- kapak mbulues dekorativ EDGE 2/3M  
- në përputhje me EN 60669-1

## OKVIR EDGE 2/3M

- dekorativni okvir EDGE 2/3M  
- uskladeno s normom EN 60669-1

metal  
metal

MA e argjendtë  
silver

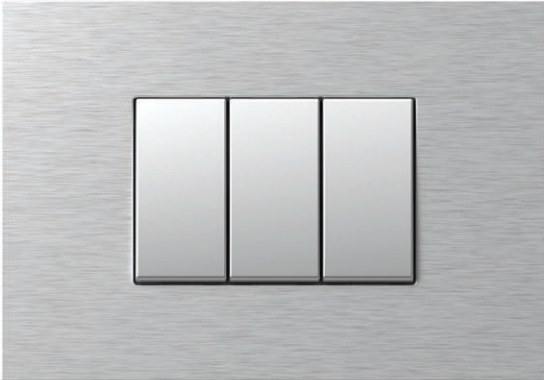

MT antracit  
anthracite



MZ e artë  
gold

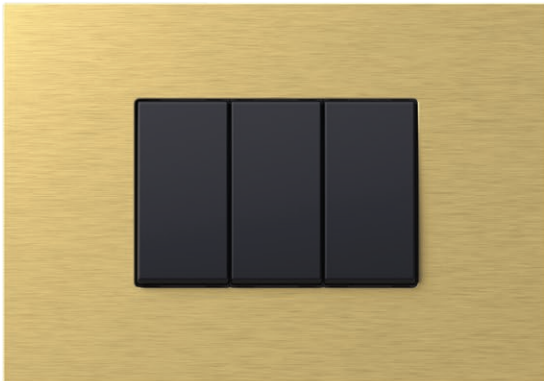

xham  
glass

GD xham i errët  
glass dark

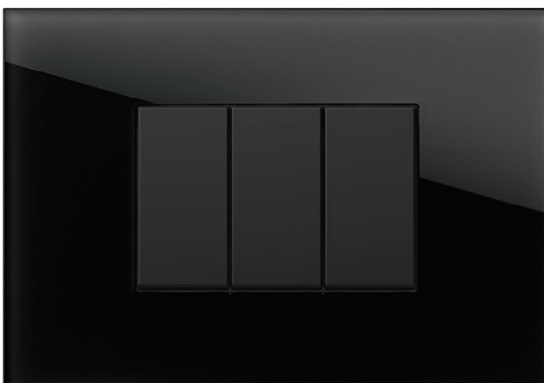

GL xham i çelur  
glas light

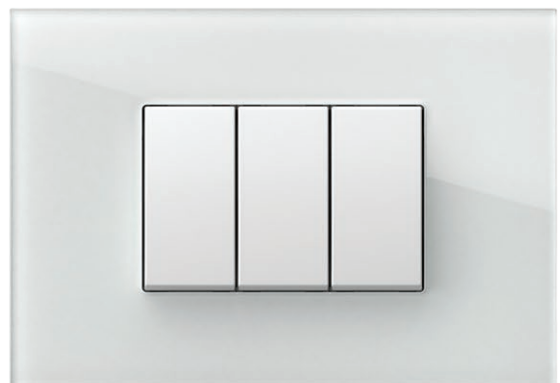

C O V E R P L A T E S E D G E O G

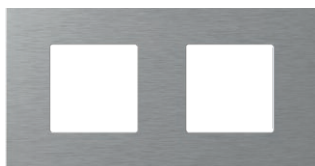

OG30

MA

M

lloji type	përshkrimi description	madhësia size	ngjyra colour
OG10	KAPAK MBULUES EDGE COVER PLATE EDGE	1/2M	MA e argjendtë silver MT antracit anthracite MZ e artë gold
OG13	KAPAK MBULUES EDGE COVER PLATE EDGE	1/3M	GD xham i errët glass dark GL xham i çelur glass light
OG20	KAPAK MBULUES EDGE COVER PLATE EDGE	2M	

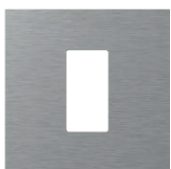
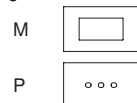

- OG10MAM
- OG10MTM
- OG10MZM
- OG10GDM
- OG10GLM

KAPAK MBULUES EDGE 1/2M

- kapak mbulues dekorativ EDGE 1/2M  
- në përputhje me EN 60669-1

COVER PLATE EDGE 1/2M

- decorative cover plate EDGE 1/2M  
- in accordance with EN 60669-1

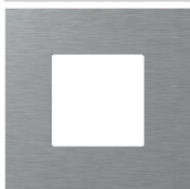

- OG20MAM
- OG20MTM
- OG20MZM
- OG20GDM
- OG20GLM

KAPAK MBULUES EDGE 2M

- kapak mbulues dekorativ EDGE 2M  
- në përputhje me EN 60669-1

COVER PLATE EDGE 2M

- decorative cover plate EDGE 2M  
- in accordance with EN 60669-1

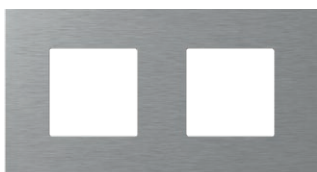

- OG24MAM
- OG24MTM
- OG24MZM
- OG24GDM
- OG24GLM

KAPAK MBULUES EDGE 2x2M

- kapak mbulues dekorativ EDGE 2x2M  
- montim horizontal ose vertikal  
- në përputhje me EN 60669-1

COVER PLATE EDGE 2x2M

- decorative cover plate EDGE 2x2M  
- horizontal or vertical mounting  
- in accordance with EN 60669-1

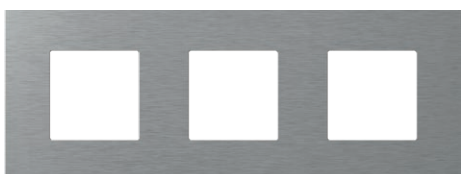

- OG26MAM
- OG26MTM
- OG26MZM
- OG26GDM
- OG26GLM

KAPAK MBULUES EDGE 3x2M

- kapak mbulues dekorativ EDGE 3x2M  
- montim horizontal ose vertikal  
- në përputhje me EN 60669-1

COVER PLATE EDGE 3x2M

- decorative cover plate EDGE 3x2M  
- horizontal or vertical mounting  
- in accordance with EN 60669-1

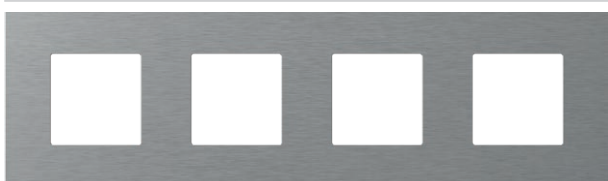

- OG28MAM
- OG28MTM
- OG28MZM
- OG28GDM
- OG28GLM

KAPAK MBULUES EDGE 4x2M

- kapak mbulues dekorativ EDGE 4x2M  
- montim horizontal ose vertikal  
- në përputhje me EN 60669-1

COVER PLATE EDGE 4x2M

- decorative cover plate EDGE 4x2M  
- horizontal or vertical mounting  
- in accordance with EN 60669-1





OG13MAM  
OG13MTM  
OG13MZM

OG13GDM  
OG13GLM

**KAPAK MBULUES EDGE 1/3M**

- kapak mbulues dekorativ EDGE 1/3M  
- në përputhje me EN 60669-1

**COVER PLATE EDGE 1/3M**

- decorative cover plate EDGE 1/3M  
- in accordance with EN 60669-1



OG30MAM  
OG30MTM  
OG30MZM

OG30GDM  
OG30GLM

**KAPAK MBULUES EDGE 3M**

- kapak mbulues dekorativ EDGE 3M  
- në përputhje me EN 60669-1

**COVER PLATE EDGE 3M**

- decorative cover plate EDGE 3M  
- in accordance with EN 60669-1



OG40MAM  
OG40MTM  
OG40MZM

OG40GDM  
OG40GLM

**KAPAK MBULUES EDGE 4M**

- kapak mbulues dekorativ EDGE 4M  
- në përputhje me EN 60669-1

**COVER PLATE EDGE 4M**

- decorative cover plate EDGE 4M  
- in accordance with EN 60669-1

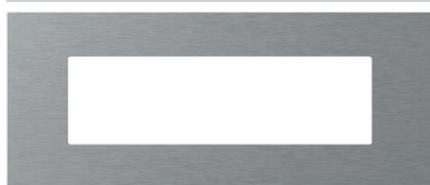

OG70MAM  
OG70MTM  
OG70MZM

OG70GDM  
OG70GLM

**KAPAK MBULUES EDGE 7M**

- kapak mbulues dekorativ EDGE 7M  
- në përputhje me EN 60669-1

**COVER PLATE EDGE 7M**

- decorative cover plate EDGE 7M  
- in accordance with EN 60669-1

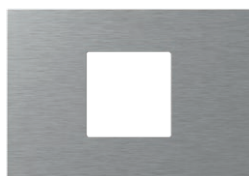

OG23MAM  
OG23MTM  
OG23MZM

OG23GDM  
OG23GLM

**KAPAK MBULUES EDGE 2/3M**

- kapak mbulues dekorativ EDGE 2/3M  
- në përputhje me EN 60669-1

**COVER PLATE EDGE 2/3M**

- decorative cover plate EDGE 2/3M  
- in accordance with EN 60669-1





MODUL  
LINE



MODUL  
SOFT



MODUL  
PURE

A x B

A x B

A x B

1/2M

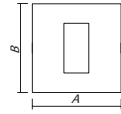

80 x 80 mm

84 x 84 mm

2M

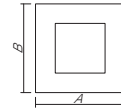

80 x 80 mm

84 x 84 mm

93 x 90 mm

2x2M

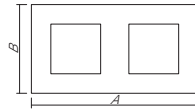

151 x 80 mm

155 x 84 mm

164 x 90 mm

3x2M

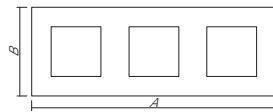

222 x 80 mm

226 x 84 mm

235 x 90 mm

4x2M

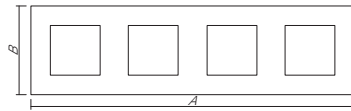

293 x 80 mm

297 x 84 mm

304 x 90 mm

5x2M

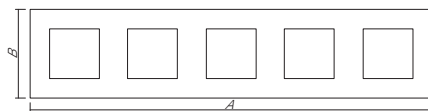

364,1 x 80 mm



1/3M

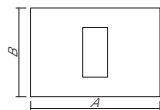

122 x 80 mm

122 x 84 mm

134 x 90 mm

3M

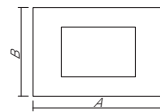

122 x 80 mm

122 x 84 mm

134 x 90 mm

4M

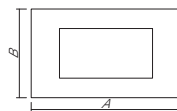

149 x 80 mm

144 x 84 mm

157 x 90 mm

7M

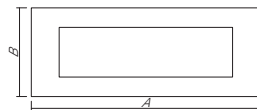

207 x 80 mm

212 x 84 mm

224 x 90 mm

2x7M

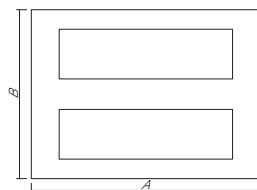

215 x 159 mm

212 x 158 mm



2/3M

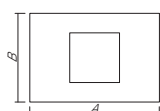

122 x 80 mm

122 x 84 mm

134 x 90 mm





MODUL  
EDGE



		$A \times B$
1/2M		92 x 92 mm
2M		92 x 92 mm
2x2M		163 x 92 mm
3x2M		234 x 92 mm
4x2M		305 x 92 mm



1/3M		132 x 92 mm
3M		132 x 92 mm
4M		154 x 92 mm
7M		222 x 92 mm



2/3M		132 x 92 mm
------	--	-------------

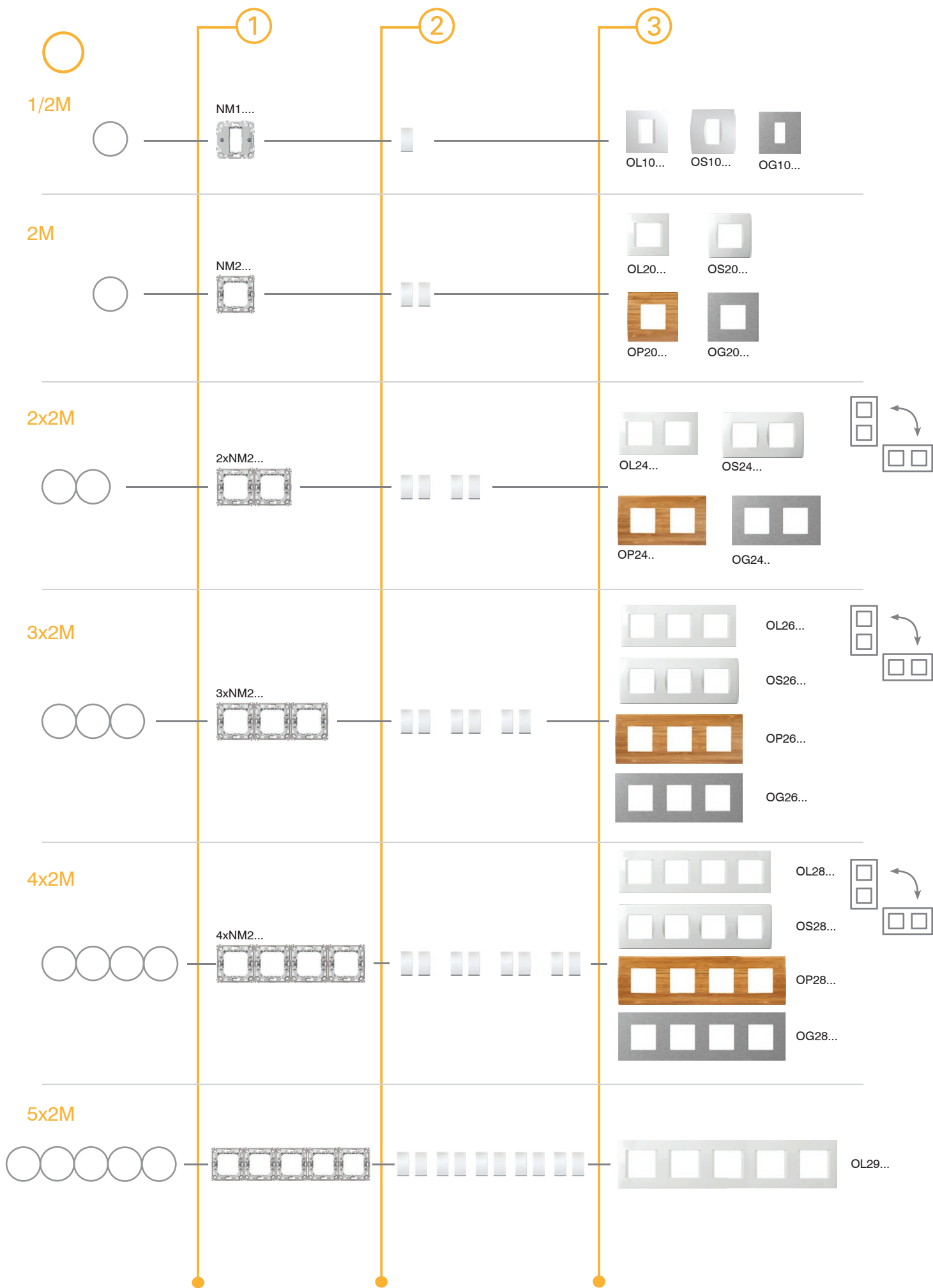

C O M B I N A T I O N S

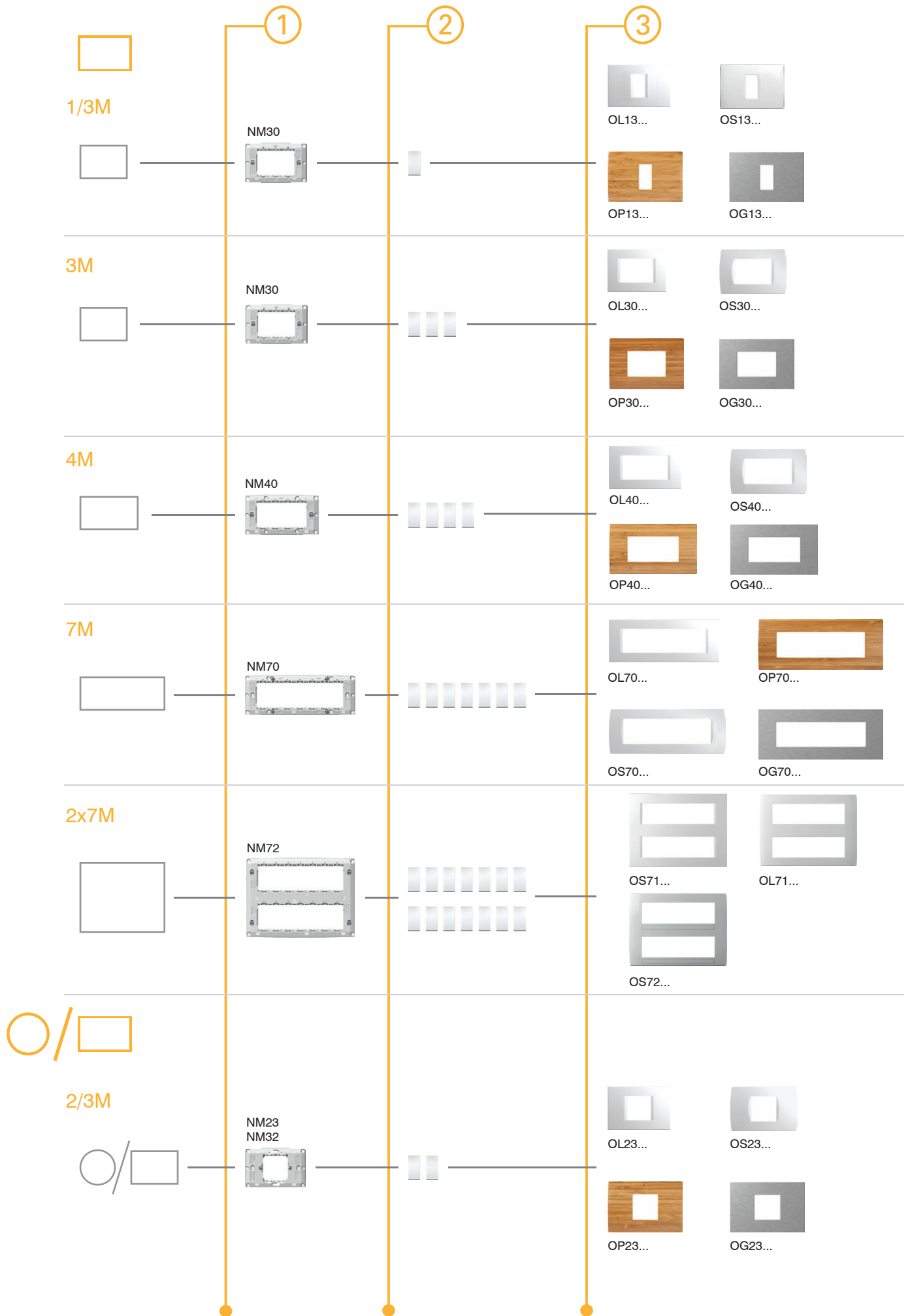



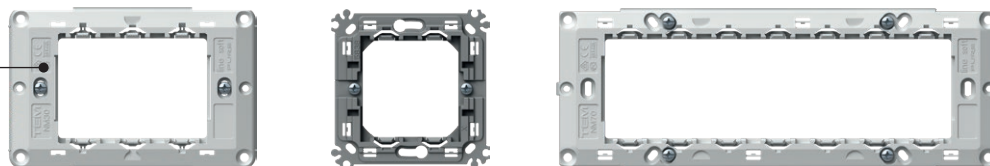

NM30

Iloji type	përshkrimi description	madhësia size
NM10	KORNIZË MONTIMI ME KTHETRA MOUNTING FRAME WITH CLAWS	1/2M
NM11	KORNIZË MONTIMI PA VIDA MOUNTING FRAME WITHOUT SCREWS	1/2M
NM20	KORNIZË MONTIMI ME KTHETRA MOUNTING FRAME WITH CLAWS	2M
...	...	...

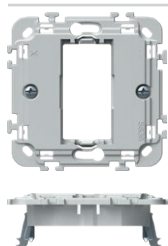

NM10

KORNIZË MONTIMI ME KTHETRA 1/2M

- kornizë montimi 1/2M me kthetra
- për montimin në kutitë Ø60 (DE..) me kthetra
- i përshtatshëm për montimin me kapakët mbulues LINE, SOFT dhe EDGE
- në përputhje me EN 60669-1

MOUNTING FRAME WITH CLAWS 1/2M

- mounting frame 1/2M with claws
- for mounting on boxes Ø60 (DE..) with claws
- suitable for assembling with cover plates LINE, SOFT and EDGE
- in accordance with EN 60669-1

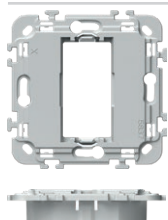
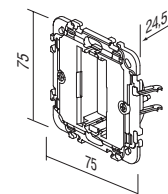

NM11

KORNIZË MONTIMI PA VIDA 1/2M

- kornizë montimi 1/2M pa vida dhe pa kthetra
- për montimin në kutitë Ø60 (HE..., DE..) me vida
- i përshtatshëm për montimin me kapakët mbulues LINE, SOFT dhe EDGE
- në përputhje me EN 60669-1

MOUNTING FRAME WITHOUT SCREWS 1/2M

- mounting frame 1/2M without screws and without claws
- for mounting on boxes Ø60 (HE..., BE..) with screws
- suitable for assembling with cover plates LINE, SOFT and EDGE
- in accordance with EN 60669-1

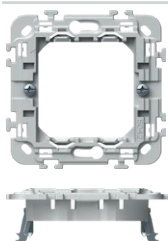
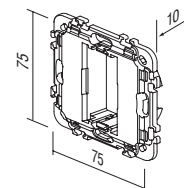

NM20

KORNIZË MONTIMI ME KTHETRA 2M

- kornizë montimi 2M me kthetra
- për montimin në kutitë Ø60 (DE..) me kthetra
- kombinime të mundshme horizontale ose vertikale 2x2M, 3x2M dhe 4x2M
- i përshtatshëm për montimin me kapakët mbulues LINE, SOFT, PURE dhe EDGE
- në përputhje me EN 60669-1

MOUNTING FRAME WITH CLAWS 2M

- mounting frame 2M with claws
- for mounting on boxes Ø60 (DE..) with claws
- possible horizontal or vertical combinations 2x2M, 3x2M and 4x2M
- suitable for assembling with cover plates LINE, SOFT, PURE and EDGE
- in accordance with EN 60669-1

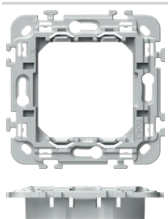
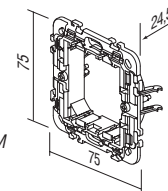

NM21

KORNIZË MONTIMI PA VIDA 2M

- kornizë montimi 2M pa vida dhe pa kthetra
- për montimin në kutitë Ø60 (HE..., DE..) me vida
- kombinime të mundshme horizontale ose vertikale 2x2M, 3x2M dhe 4x2M
- i përshtatshëm për montimin me kapakët mbulues LINE, SOFT, PURE dhe EDGE
- në përputhje me EN 60669-1

MOUNTING FRAME WITHOUT SCREWS 2M

- mounting frame 2M without screws and without claws
- for mounting on boxes Ø60 (HE..., BE..) with screws
- possible horizontal or vertical combinations 2x2M, 3x2M and 4x2M
- suitable for assembling with cover plates LINE, SOFT, PURE and EDGE
- in accordance with EN 60669-1

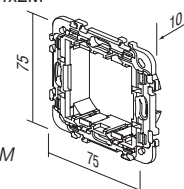

## M O U N T I N G F R A M E S N M

## KORNIZË MONTIMI METALIKE ME KTHETRA 2M

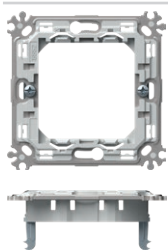

NM24

- kornizë montimi metalike 2M me kthetra - versioni i fortë
- për montimin në kutitë Ø60 (DE..) me kthetra
- kombinime të mundshme horizontale ose vertikale 2x2M, 3x2M dhe 4x2M
- i përshtatshëm për montimin me kapakët mbulues LINE, SOFT, PURE dhe EDGE
- në përputhje me EN 60669-1

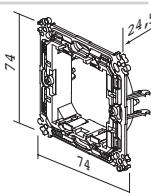
*MOUNTING FRAME METAL WITH CLAWS 2M*

- metal mounting frame 2M with claws - stiff version
- for mounting on boxes Ø60 (DE..) with claws
- possible horizontal or vertical combinations 2x2M, 3x2M and 4x2M
- suitable for assembling with cover plates LINE, SOFT, PURE and EDGE
- in accordance with EN 60669-1

## KORNIZË MONTIMI METALIKE PA VIDA 2M

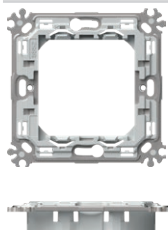

NM25

- kornizë montimi metalike me vida dhe pa kthetra - versioni i fortë
- për montimin në kutitë Ø60 (HE..., BE...) me vida
- kombinime të mundshme horizontale ose vertikale 2x2M, 3x2M dhe 4x2M
- i përshtatshëm për montimin me kapakët mbulues LINE, SOFT, PURE dhe EDGE
- në përputhje me EN 60669-1

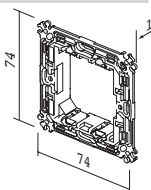
*MOUNTING FRAME METAL WITHOUT SCREWS 2M*

- metal mounting frame 2M without screws and without claws - stiff version
- for mounting in boxes Ø60 (HE..., BE...) with screws
- possible horizontal or vertical combinations 2x2M, 3x2M and 4x2M
- suitable for assembling with cover plates LINE, SOFT, PURE and EDGE
- in accordance with EN 60669-1

## KORNIZË MONTIMI 2M E PËRFORCUAR ME KTHETRA

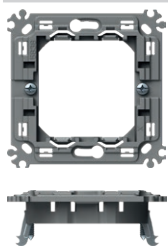

NM26

- kornizë montimi metalike 2M e përforcuar me kthetra - versioni i fortë
- për montimin në kutitë Ø60 (DE..) me kthetra
- kombinime të mundshme horizontale ose vertikale 2x2M, 3x2M dhe 4x2M
- i përshtatshëm për montimin me kapakët mbulues LINE, SOFT, PURE dhe EDGE
- në përputhje me EN 60669-1

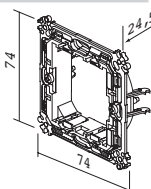
*CLAW REINFORCED MOUNTING FRAME 2M*

- 2M mounting frame reinforced with claws - stiff version
- for mounting on boxes Ø60 (DE..) with claws
- possible horizontal or vertical combinations 2x2M, 3x2M and 4x2M
- suitable for assembling with cover plates LINE, SOFT, PURE and EDGE
- in accordance with EN 60669-1

## KORNIZË MONTIMI 2 M E PËRFORCUAR PA VIDA

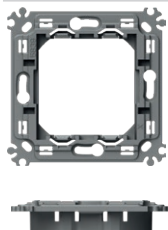

NM27

- kornizë montimi e përforcuar me vida dhe pa kthetra - versioni i fortë
- për montimin në kutitë Ø60 (HE... BE...) me vida
- kombinime të mundshme horizontale ose vertikale 2x2M, 3x2M dhe 4x2M
- i përshtatshëm për montimin me kapakët mbulues LINE, SOFT, PURE dhe EDGE
- në përputhje me EN 60669-1

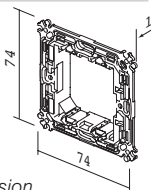
*REINFORCED MOUNTING FRAME WITHOUT SCREWS 2M*

- reinforced mounting frame without screws or claws - stiff version
- for mounting in boxes Ø60 (HE..., BE...) with screws
- possible horizontal or vertical combinations 2x2M, 3x2M and 4x2M
- suitable for assembling with cover plates LINE, SOFT, PURE and EDGE
- in accordance with EN 60669-1

## KORNIZË MONTIMI ME KTHETRA 2/3M

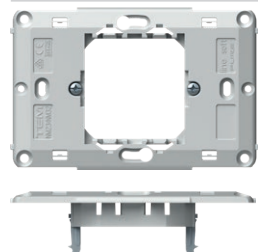

NM23

- kornizë montimi 2/3M me kthetra
- për montimin në kutitë Ø60 (DE..) me kthetra
- i përshtatshëm për montimin me kapakët mbulues LINE, SOFT, PURE dhe EDGE
- në përputhje me EN 60669-1

*MOUNTING FRAME WITH CLAWS 2/3M*

- mounting frame 2/3M with claws
- for mounting on boxes Ø60 (DE..) with claws
- suitable for assembling with cover plates LINE, SOFT, PURE and EDGE
- in accordance with EN 60669-1

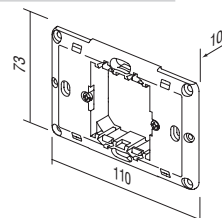



**KORNIZË MONTIMI ME VIDA 3M**

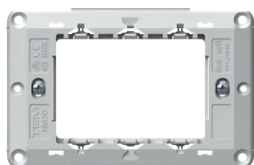

NM30

- kornizë montimi 3M me vida
- për montim në kutitë drejtkëndore 3M
- i përshtatshëm për montimin me kapakët mbulues LINE, SOFT, PURE dhe EDGE
- në përputhje me EN 60669-1

**MOUNTING FRAME WITH SCREWS 3M**

- mounting frame 3M with screws
- for mounting on rectangular boxes 3M
- suitable for assembling with cover plates LINE, SOFT, PURE and EDGE
- in accordance with EN 60669-1

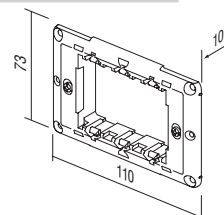

**KORNIZË MONTIMI ME VIDA 4M**



NM40

- kornizë montimi 4M me vida
- për montim në kutitë drejtkëndore 4M
- i përshtatshëm për montimin me kapakët mbulues LINE, SOFT, PURE dhe EDGE
- në përputhje me EN 60669-1

**MOUNTING FRAME WITH SCREWS 4M**

- mounting frame 4M with screws
- for mounting on rectangular boxes 4M
- suitable for assembling with cover plates LINE, SOFT, PURE and EDGE
- in accordance with EN 60669-1

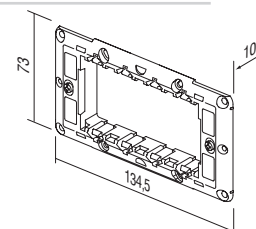

**KORNIZË MONTIMI ME VIDA 7M**



NM70

- kornizë montimi 7M me vida
- për montim në kutitë drejtkëndore 7M
- i përshtatshëm për montimin me kapakët mbulues LINE, SOFT, PURE dhe EDGE
- në përputhje me EN 60669-1

**MOUNTING FRAME WITH SCREWS 7M**

- mounting frame 7M with screws
- for mounting on rectangular boxes 7M
- suitable for assembling with cover plates 7M
- in accordance with EN 60669-1

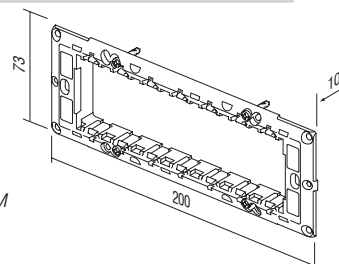

**KORNIZË MONTIMI ME VIDA 2x7M**

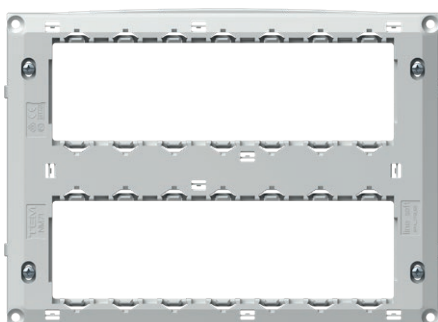

NM72

- kornizë montimi me vida 2x7M
- për montim në kutitë drejtkëndore 2x7M
- i përshtatshëm për montimin me kapak mbulues 2x7M
- në përputhje me EN 60669-1

**MOUNTING FRAME WITH SCREWS 2x7M**

- mounting frame 2x7M with screws
- for mounting on rectangular boxes 2x7M
- suitable for assembling with cover plates 2x7M
- in accordance with EN 60669-1

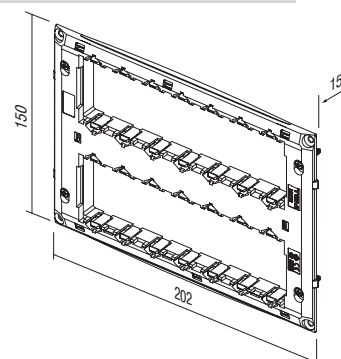

**KORNIZË MONTIMI ME VIDA 2/3M**

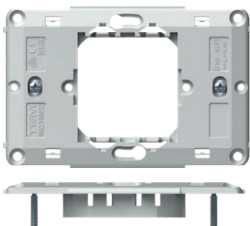

NM32

- kornizë montimi 2/3M me vida
- për montim në kutitë drejtkëndore 3M
- i përshtatshëm për montimin me kapakët mbulues LINE, SOFT, PURE dhe EDGE
- në përputhje me EN 60669-1

**MOUNTING FRAME WITH SCREWS 2/3M**

- mounting frame 2/3M with screws
- for mounting on rectangular boxes 3M
- suitable for assembling with cover plates LINE, SOFT, PURE and EDGE
- in accordance with EN 60669-1

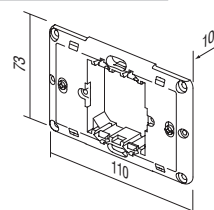







142



150



158



160





## KUTITĚ

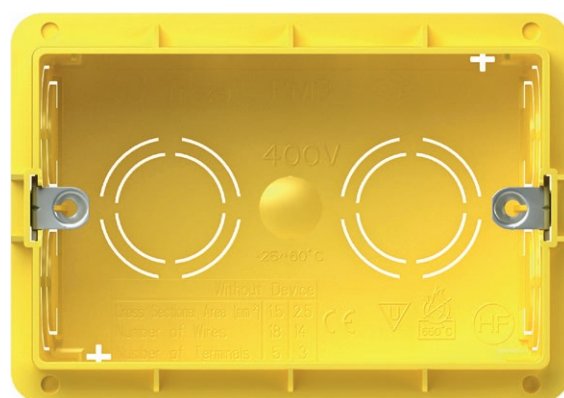

**TEM**



# K U T I T Ë E R R U M B U L L A K Ë T A

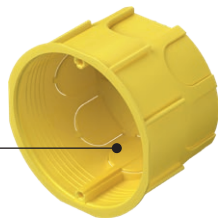

DE12



HE11



BE10

lloji type	përshkrimi description	madhësia size
DE10	KUTI E RRUMBULLAKËT TULLË ROUND BOX BRICK	SM60-01
HE10	KUTI E RRUMBULLAKËT MUR BOSH ROUND BOX HOLLOW WALL	SM68X40
BE10	KUTI E RRUMBULLAKËT BETON ROUND BOX CONCRETE	
:	:	:

## KUTI E RRUMBULLAKËT TULLË SM60-01



DE10

- Ø60, thellësia 40 mm
- 650°C, 500 V~
- në përputhje me IEC 60670-1
- pa halogjenë
- opsioni i montimit të kornizës së montimit me vidë Ø 3 mm

### ROUND BOX BRICK SM60-01

- Ø60, depth 40mm
- 650°C, 500V~
- in accordance with IEC 60670-1
- halogen free
- option of mounting the mounting frame with Ø 3 mm screws

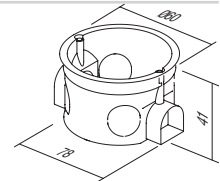

## KUTI E RRUMBULLAKËT TULLË E THELLË SM60-06



DE11

- Ø60, thellësia 60mm
- 650°C, 500 V~
- në përputhje me IEC 60670-1
- pa halogjenë
- opsioni i montimit të kornizës së montimit me vidë Ø 3 mm

### ROUND BOX BRICK DEEP SM60-06

- Ø60, depth 60mm
- 650°C, 500V~
- in accordance with IEC 60670-1
- halogen free
- option of mounting the mounting frame with Ø 3 mm screws

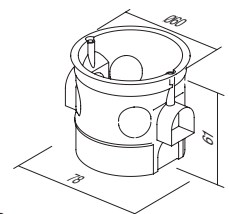

## KAPËSE E KOMBINUAR SM60-03



DE30

- për montimin vertikal të kutive SM60-06 ose SM60-01
- në distancë prej 91 mm
- në përputhje me IEC 60670-1
- pa halogjenë

### COMBI-CLIP SM60-03

- for vertical fitting of boxes SM60-06 or SM60-01 on distance 91 mm
- in accordance with IEC 60670-1
- halogen free

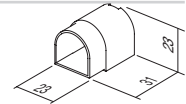

## KAPËSE E KOMBINUAR SM60-04

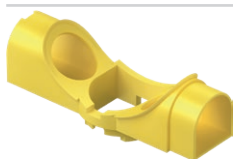

DE31







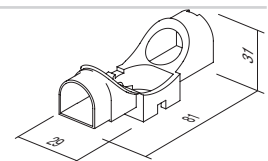



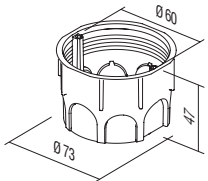

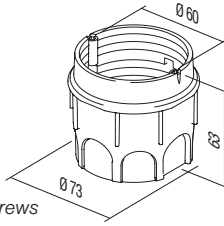

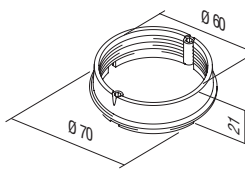
- për montimin horizontal të kutive SM60-06 ose SM60-01
- në distancë prej 71mm
- në përputhje me IEC 60670-1
- pa halogjenë

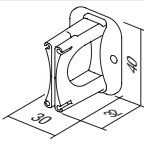
### COMBI-CLIP SM60-04

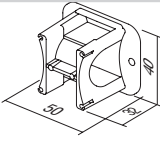
- for horizontal fitting of boxes SM60-06 or SM60-01 on distance 71mm
- in accordance with IEC 60670-1
- halogen free

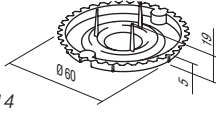

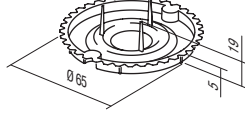
## R O U N D     B O X E S

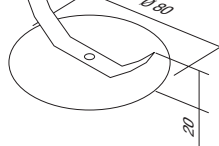
	DE12	<b>KUTI E RRUMBULLAKËT TULLË MD65-46</b> - Ø65, thellësia 46 mm - 650 °C, 500 V~ - në përputhje me IEC 60670-1 - pa halogjenë - opsioni i montimit të kornizës së montimit me vidë Ø 3 mm	
		<b>ROUND BOX BRICK MD65-46</b> - Ø65, depth 46mm - 650°C, 500V~ - in accordance with IEC 60670-1 - halogen free - option of mounting the mounting frame with Ø 3 mm screws	
	DE13	<b>KUTI E RRUMBULLAKËT TULLË E THELLË MD65-60</b> - Ø65/60, thellësia 62 mm - 650 °C, 500 V~ - në përputhje me IEC 60670-1 - pa halogjenë - opsioni i montimit të kornizës së montimit me vidë Ø 3 mm	
		<b>ROUND BOX BRICK DEEP MD65-60</b> - Ø65/60, depth 62mm - 650°C, 500V~ - in accordance with IEC 60670-1 - halogen free - option of mounting the mounting frame with Ø 3 mm screws	
	DE14	<b>PJESË SHITESË PËR MD65-46</b> - Ø65/60, thellësia 17mm - 650 °C, 500 V~ - në përputhje me IEC 60670-1 - pa halogjenë	
		<b>ADDITIONAL PIECE FOR MD65-46</b> - Ø65/60, depth 17mm - 650°C, 500V~ - in accordance with IEC 60670-1 - halogen free	
	DE32	<b>KAPËSE E KOMBINUAR MD65-71</b> - për montimin e kutive MD65 në distancë prej 71 mm - në përputhje me IEC 60670-1 - pa halogjenë	
		<b>COMBI-CLIP MD65-71</b> - for fitting of boxes MD65 on distance 71mm - in accordance with IEC 60670-1 - halogen free	
	DE33	<b>KAPËSE E KOMBINUAR MD65-91</b> - për montimin e kutive MD65 në distancë prej 91mm - në përputhje me IEC 60670-1 - pa halogjenë	
		<b>COMBI-CLIP MD65-91</b> - for fitting of boxes MD65 on distance 91mm - in accordance with IEC 60670-1 - halogen free	
	DE20	<b>KAPAK MBROJTËS PËR KUTI 60</b> - kapak mbrojtës për kuti Ø60 për DE10, DE11, DE13, DE14 - në përputhje me IEC 60670-1 - mbrojtje për kuti gjatë suvatimit	
		<b>BOX COVER PROTECTIVE 60</b> - protective cover for box Ø60 for DE10, DE11, DE13, DE14 - in accordance with IEC 60670-1 - box protection during plastering	
	DE21	<b>KAPAK MBROJTËS PËR KUTI 65</b> - kapak mbrojtës për kuti Ø65 për DE12 - në përputhje me IEC 60670-1 - mbrojtje për kuti gjatë suvatimit	
		<b>BOX COVER PROTECTIVE 65</b> - protective cover for box Ø65 for DE12 - in accordance with IEC 60670-1 - box protection during plastering	
	DE22	<b>KAPAK DEKORATIV PËR KUTI SM60</b> - kapak dekorativ për kuti Ø60 - në përputhje me IEC 60670-1 - pa halogjenë	
		<b>BOX COVER DECORATIVE SM60</b> - decorative cover for boxes Ø60 - in accordance with IEC 60670-1 - halogen free	

# K U T I T Ë E R R U M B U L L A K Ë T A



udhëzime për montimin /  
assembly instructions

distanca mes kutive /  
distance between boxes: 71mm

distanca mes kutive /  
distance between boxes: 91mm

DE10,11

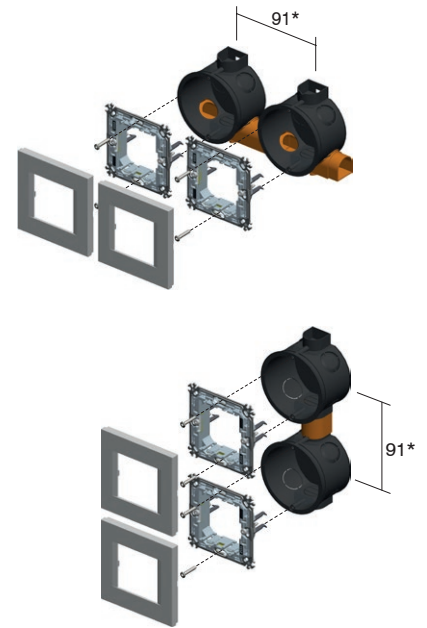
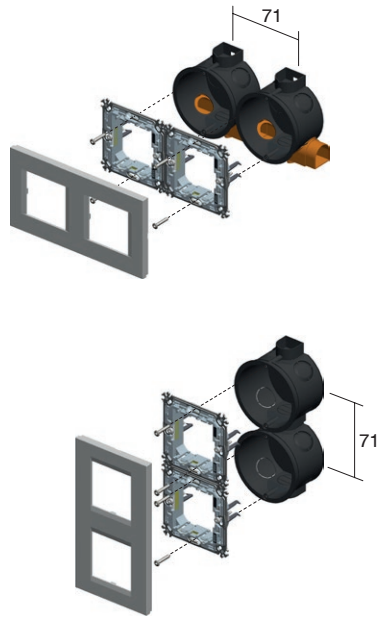
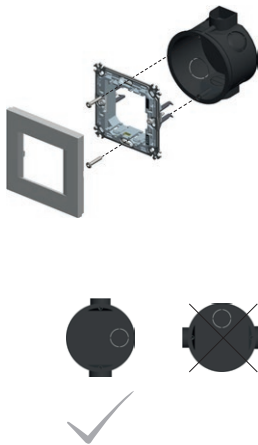

DE12,13

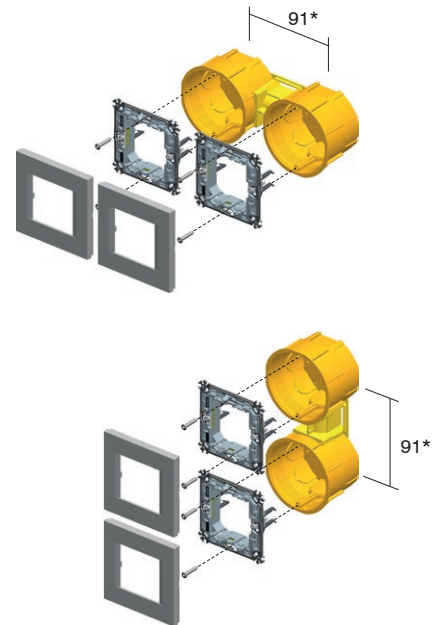
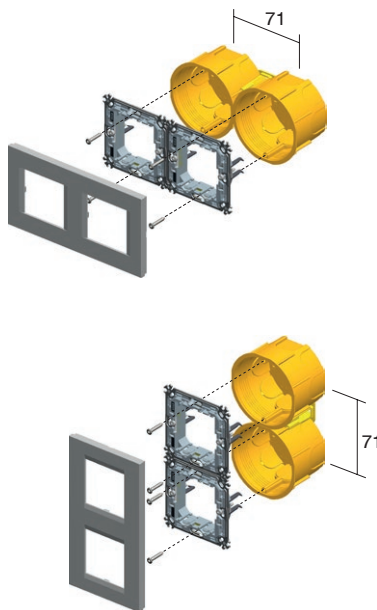
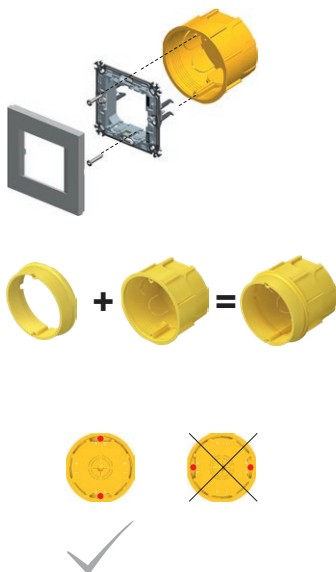

\* për kapakët mbulues PURE, EDGE distanca minimale mes kutive është 100 mm  
\* for PURE, EDGE cover plates the minimum distance between boxes is 100mm



R O U N D B O X E S



DE10,11



DE12,13



NM20



NM24



DE10,11



DE12,13



NM10



DE10,11



DE12,13



NM23



71

2xDE10,11 + 2xDE31



2xNM20



2xDE12,13 + 1xDE32



2xNM24



2xDE10,11 2xDE12,13 + 1xDE32



2xNM20



2xNM24



3xDE10,11 + 3xDE31



3xNM20



3xDE12,13 + 2xDE32



3xNM24

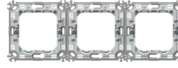

3xDE10,11 3xDE12,13 + 2xDE32

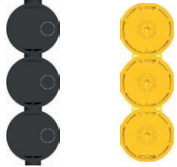

3xNM20



3xNM24



4xDE10,11 + 4xDE31



4xNM20



4xDE12,13 + 3xDE32



4xNM24



4xDE10,11 4xDE12,13 + 3xDE32

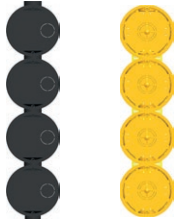

4xNM20



4xNM24



5xDE10,11

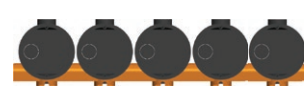

5xNM20



5xDE12,13 + 4xDE32



5xNM24



**KUTI E RRUMBULLAKËT MUR BOSH SM68x40**



HE10

- Ø60, thellësia 40 mm
- vrima e prerjes Ø68
- 850°C, 400V~
- në përputhje me IEC 60670-1
- montim me kthetra
- pa halogjenë
- montimi i kornizës së montimit me vidë Ø 3 mm

**ROUND BOX HOLLOW WALL SM68x40**

- Ø60, depth 40mm
- cutting hole Ø68
- 850°C, 400V~
- in accordance with IEC 60670-1
- mounting with claws
- halogen free
- mounting the mounting frame with Ø 3 mm screws

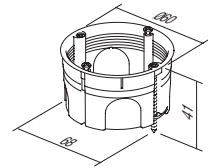

**KUTI E RRUMBULLAKËT MUR BOSH SM68x55**



HE11

- Ø60, thellësia 55mm
- vrima e prerjes Ø68
- 850°C, 400V~
- në përputhje me IEC 60670-1
- montim me kthetra
- pa halogjenë
- montimi i kornizës së montimit me vidë Ø 3 mm

**ROUND BOX HOLLOW WALL SM68x55**

- Ø60, depth 55mm
- cutting hole Ø68
- 850°C, 400V~
- in accordance with IEC 60670-1
- mounting with claws
- halogen free
- mounting the mounting frame with Ø 3 mm screws

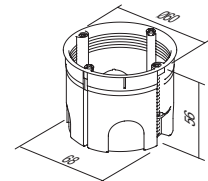

**KUTI E RRUMBULLAKËT BETON**



BE10

- Ø60, thellësia 49mm
- 650°C, 500 V~
- në përputhje me IEC 60670-1
- pa halogjenë
- montimi i kornizës së montimit me vidë Ø 3 mm

**ROUND BOX CONCRETE**

- Ø60mm, depth 49mm
- 650°C, 500V~
- in accordance with IEC 60670-1
- halogen free
- mounting the mounting frame with Ø 3 mm screws

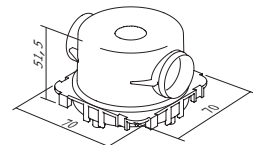

**KUTI E RRUMBULLAKËT BETON E THELLË**



BE11

- Ø60, thellësia 58mm
- 650°C, 500 V~
- në përputhje me IEC 60670-1
- pa halogjenë
- montimi i kornizës së montimit me vidë Ø 3 mm

**ROUND BOX CONCRETE DEEP**

- Ø60mm, depth 58mm
- 650°C, 500V~
- in accordance with IEC 60670-1
- halogen free
- mounting the mounting frame with Ø 3 mm screws

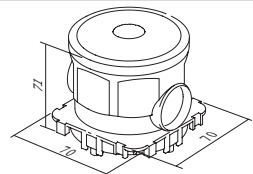

**KUNDËR-SUPORT KUTIE PËR BETON**



BE20

- për suportin e kutive për beton me profil në distancë BM82 muri përballë
- në përputhje me IEC 60670-1
- pa halogjenë

**COUNTER BOX SUPPORT CONCRETE**

- to support concrete boxes with discance profile BM82 for extreme loads
- in accordance with IEC 60670-1
- halogen free

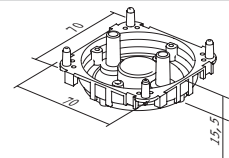

**KUTI PËR BETON PËR BLOKUES TUBI 16**



BE21

- për mbajtjen e tubit të instalimit në kuti
- në përputhje me IEC 60670-1
- pa halogjenë

**PIPE STOPPER CONCRETE BOX 16**

- for firming installation pipe to box
- in accordance with IEC 60670-1
- halogen free

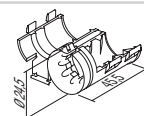

R O U N D B O X E S

mure bosh / hollow walls



beton / concrete



udhëzime për montimin /  
assembly instructions

distanca mes kutive /  
distance between boxes: 71mm

distanca mes kutive /  
distance between boxes: 91mm

HE10,11

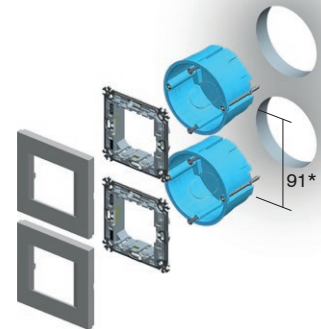
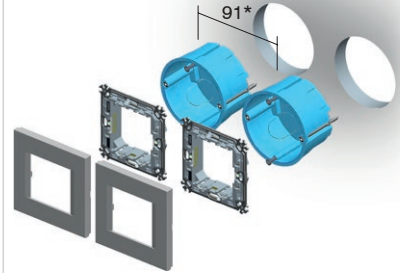
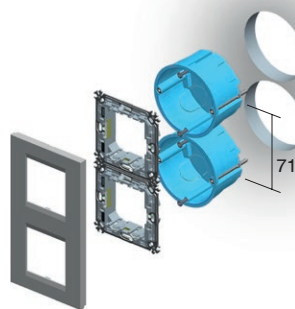
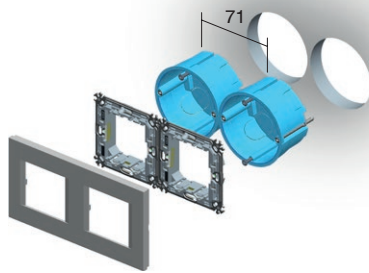
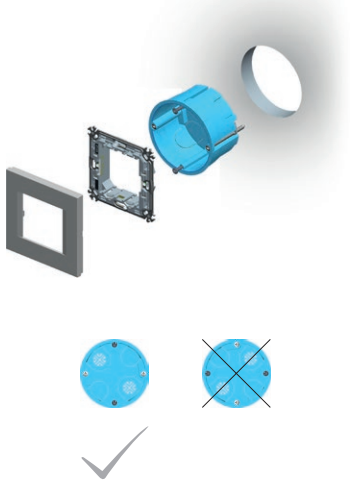

BE10

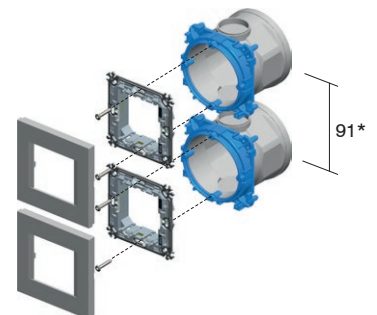
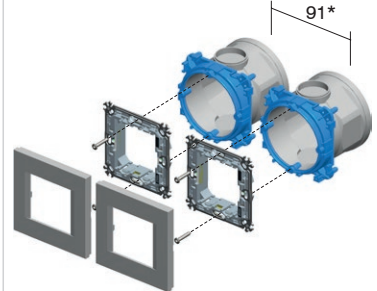
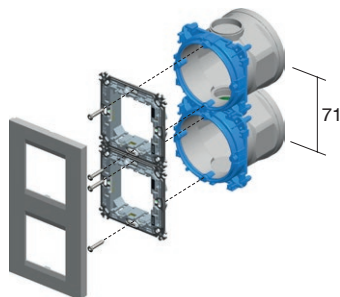
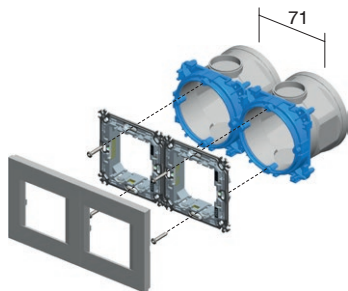
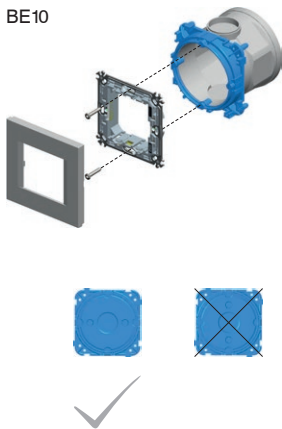

\* për kapakët mbulues PURE, EDGE distanca minimale mes kutive është 100 mm  
\* for PURE, EDGE cover plates the minimum distance between boxes is 100mm



# K U T I T Ě E R R U M B U L L A K Ě T A

mure bosh / hollow walls



beton / concrete



HE10,11



BE10,11



NM21



NM25



2M

HE10,11



BE10,11



NM11



1/2M

2xHE10,11

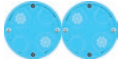

2xBE10,11



2xNM21



2xNM25



2x2M

HE10,11



BE10,11



NM32



2/3M

2xHE10,11



2xBE10,11



2xNM21



2xNM25



5xHE10,11



5xNM21



5xBE10,11



5xNM25



5x2M

3xHE10,11

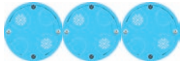

3xBE10,11



3xNM21

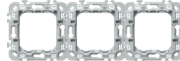

3xNM25

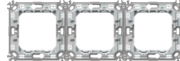

3x2M

3xHE10,11



3xBE10,11



3xNM21



3xNM25

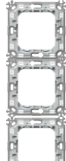

4xHE10,11



4xBE10,11



4xNM21



4xNM25



4x2M

4xHE10,11



4xBE10,11



4xNM21



4xNM25



R O U N D     B O X E S

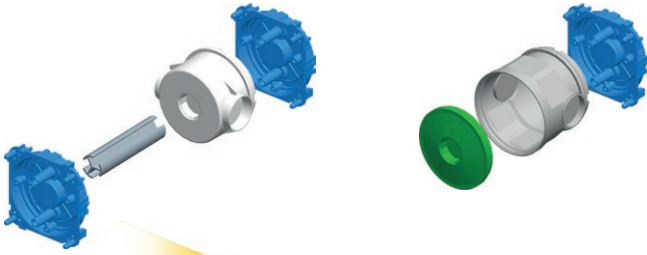

udhëzime për montimin /  
assembly instructions

1

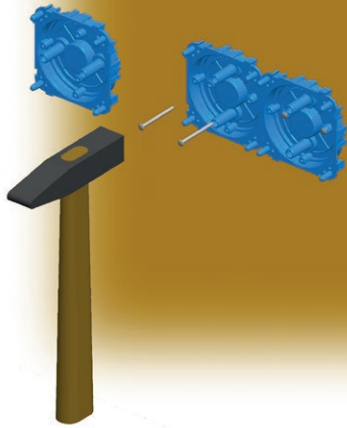

2

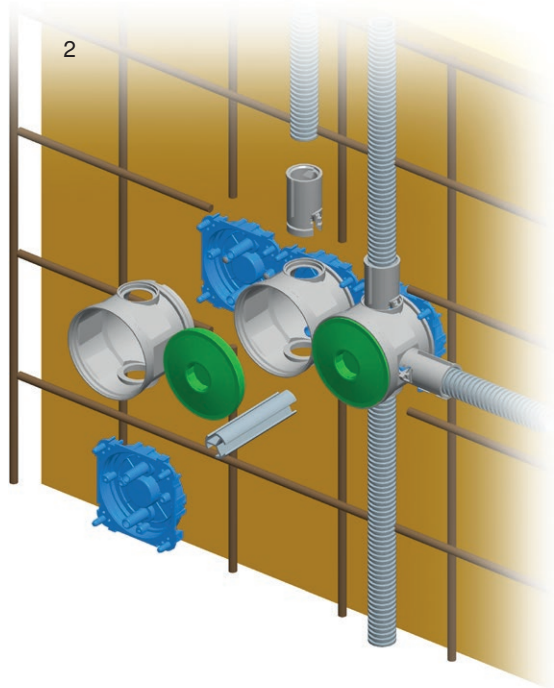

3

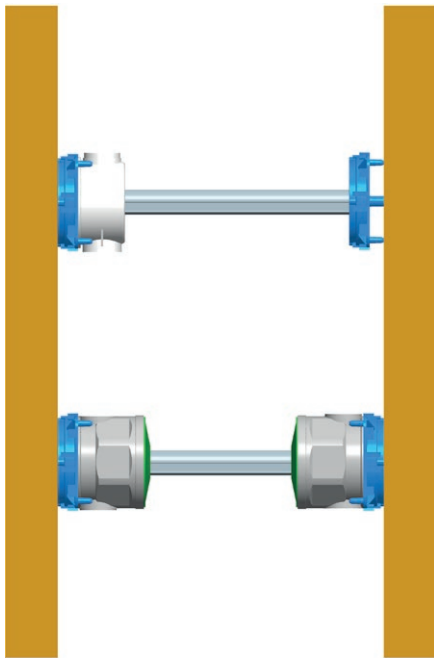

4

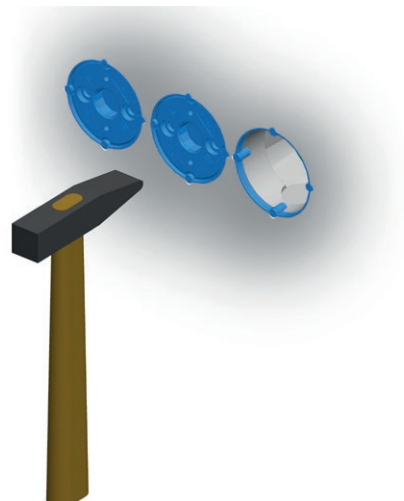

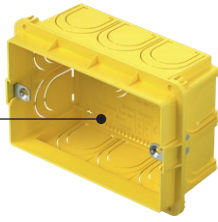

DM30



HM30



BM30

Iloji type	përshkrimi description	madhësia size
DM30	KUTI DREJTKËNDORE TULLË RECTANGULAR BOX BRICK	PM3
HM30	KUTI DREJTKËNDORE MUR BOSH RECTANGULAR BOX HOLLOW WALL	VM3
BM30	KUTI DREJTKËNDORE BETON RECTANGULAR BOX CONCRETE	BM3
·	·	·
·	·	·

KUTI DREJTKËNDORE TULLË PM3



DM30

- madhësia 3M, thellësia 49 mm
- 650°C, 400V~
- në përputhje me IEC 60670-1
- pa halogjenë

RECTANGULAR BOX BRICK PM3

- size 3M, depth 49mm
- 650°C, 400V~
- in accordance with IEC 60670-1
- halogen free

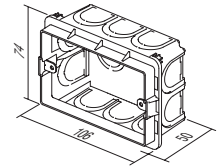

KUTI DREJTKËNDORE TULLË PM3-65



DM31

- madhësia 3M, thellësia 65mm
- 650°C, 400V~
- në përputhje me IEC 60670-1
- pa halogjenë

RECTANGULAR BOX BRICK PM3-65

- size 3M, depth 65mm
- 650°C, 400V~
- in accordance with IEC 60670-1
- halogen free

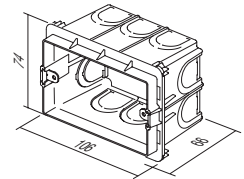

KUTI DREJTKËNDORE TULLË PM4



DM40

- madhësia 4M, thellësia 49 mm
- 650°C, 400V~
- në përputhje me IEC 60670-1
- pa halogjenë

RECTANGULAR BOX BRICK PM4

- size 4M, depth 49mm
- 650°C, 400V~
- in accordance with IEC 60670-1
- halogen free

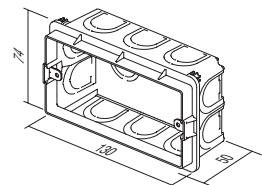

KUTI DREJTKËNDORE TULLË PM4-65



DM41

- madhësia 4M, thellësia 65mm
- 650°C, 400V~
- në përputhje me IEC 60670-1
- pa halogjenë

RECTANGULAR BOX BRICK PM4-65

- size 4M, depth 65mm
- 650°C, 400V~
- in accordance with IEC 60670-1
- halogen free

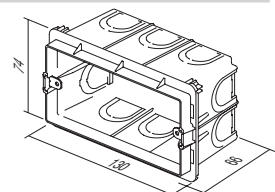



R E C T A N G U L A R   B O X E S

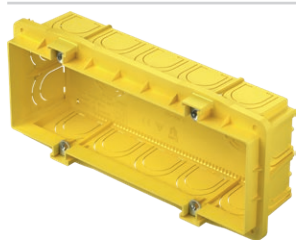

DM70

KUTI DREJTKËNDORE TULLË PM7

- madhësia 7M, thellësia 49 mm
- 650°C, 400V~
- në përputhje me IEC 60670-1
- pa halogjenë

RECTANGULAR BOX BRICK PM7

- size 7M, depth 49mm
- 650°C, 400V~
- in accordance with IEC 60670-1
- halogen free

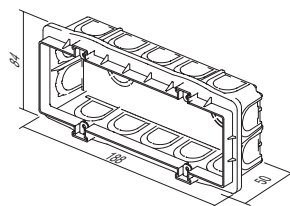

DM71

KUTI DREJTKËNDORE TULLË PM7-65

- madhësia 7M, thellësia 65mm
- 650°C, 400V~
- në përputhje me IEC 60670-1
- pa halogjenë

RECTANGULAR BOX BRICK PM7-65

- size 7M, depth 65mm
- 650°C, 400V~
- in accordance with IEC 60670-1
- halogen free

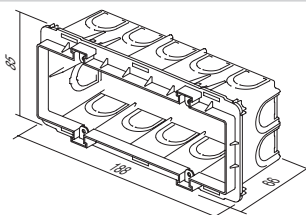

DM72

KUTI DREJTKËNDORE TULLË PM72-65

- madhësia 2x7M, thellësia 64mm
- 650°C, 400V~
- në përputhje me IEC 60670-1
- pa halogjenë

RECTANGULAR BOX BRICK PM72-65

- size 2x7M, depth 64mm
- 650°C, 400V~
- in accordance with IEC 60670-1
- halogen free

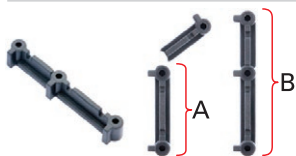
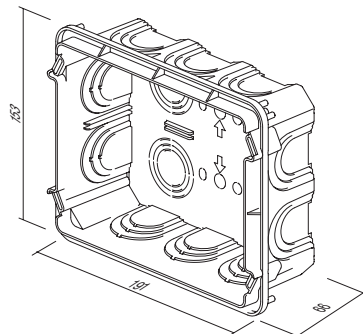

DM80

PJESË DISTANCUESE PËR KUTI PM

- për montim vertikal (A) dhe horizontal (B) të kutive PM3, PM4 në PM7
- i përshtatshëm për kapakë mbulues dekorativë Line dhe Soft (jo për PURE, EDGE)

DISTANCE PIECE FOR BOX PM

- for vertical (A) and horizontal (B) fitting of boxes PM3, PM4 and PM7
- suitable for Line and Soft decorative cover plates (not for PURE and EDGE)

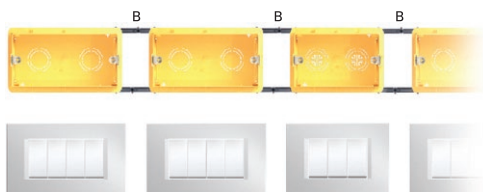
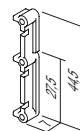



DM33

**KAPAK MBROJTËS PËR KUTI PM3**

- kapak mbrojtës për kuti PM3
- në përputhje me IEC 60670-1
- pa halogjenë
- mbrojtje për kuti gjatë suvatimit

*BOX COVER PROTECTIVE PM3*

- protective cover for box PM3
- in accordance with IEC 60670-1
- halogen free
- box protection during plastering

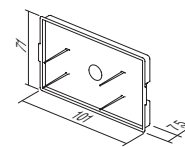

DM34

**KAPAK DEKORATIV PËR KUTI PM3**

- kapak dekorativ për kuti 3M
- vidat janë të përfshira
- në përputhje me IEC 60670-1
- pa halogjenë

*BOX COVER DECORATIVE PM3*

- decorative cover for boxes 3M
- screws are included
- in accordance with IEC 60670-1
- halogen free

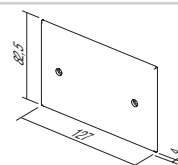

DM43

**KAPAK MBROJTËS PËR KUTI PM4**

- kapak mbrojtës për kuti PM4
- në përputhje me IEC 60670-1
- pa halogjenë
- mbrojtje për kuti gjatë suvatimit

*BOX COVER PROTECTIVE PM4*

- protective cover for box PM4
- in accordance with IEC 60670-1
- halogen free
- box protection during plastering

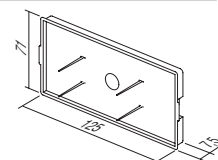

DM44

**KAPAK DEKORATIV PËR KUTI PM4**

- kapak dekorativ për kuti 4M
- vidat janë të përfshira
- në përputhje me IEC 60670-1
- pa halogjenë

*BOX COVER DECORATIVE PM4*

- decorative cover for boxes 4M
- screws are included
- in accordance with IEC 60670-1
- halogen free

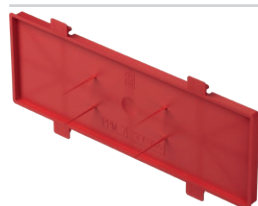
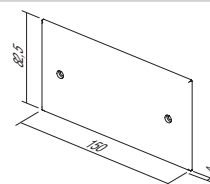

DM73

**KAPAK MBROJTËS PËR KUTI PM7**

- kapak mbrojtës për kuti PM7
- në përputhje me IEC 60670-1
- pa halogjenë
- mbrojtje për kuti gjatë suvatimit

*BOX COVER PROTECTIVE PM7*

- protective cover for box PM7
- in accordance with IEC 60670-1
- halogen free
- box protection during plastering

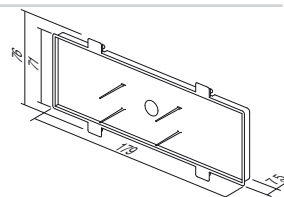

DM74

**KAPAK DEKORATIV PËR KUTI PM7**

- kapak dekorativ për kuti 7M
- vidat janë të përfshira
- në përputhje me IEC 60670-1
- pa halogjenë

*BOX COVER DECORATIVE PM7*

- decorative cover for boxes 7M
- screws are included
- in accordance with IEC 60670-1
- halogen free

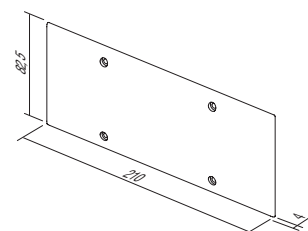

## R E C T A N G U L A R   B O X E S



DM75

## KAPAK DEKORATIV PËR KUTI PM72

- kapak dekorativ për kuti 2x7M
- vidat janë të përfshira
- në përputhje me IEC 60670-1

*BOX COVER DECORATIVE PM72*

- decorative cover for boxes 2x7M
- screws are included
- in accordance with IEC 60670-1

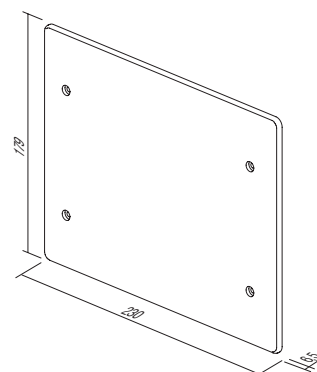

KUTI DREJTKËNDORE MUR BOSH VM3



HM30

- madhësia 3M, thellësia 49 mm
- vrima e prerjes 2xØ68/45mm
- 850°C, 400V~
- në përputhje me IEC 60670-1
- pa halogjenë

RECTANGULAR BOX HOLLOW WALL VM3

- size 3M, depth 49mm
- cutting hole 2xØ68/45mm
- 850°C, 400V~
- in accordance with IEC 60670-1
- halogen free

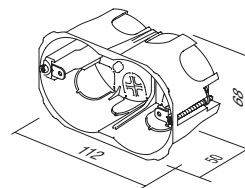

KUTI DREJTKËNDORE MUR BOSH VM4



HM40

- madhësia 4M, thellësia 49 mm
- vrima e prerjes 2xØ68/70mm
- 850°C, 400V~
- në përputhje me IEC 60670-1
- pa halogjenë

RECTANGULAR BOX HOLLOW WALL VM4

- size 4M, depth 49mm
- cutting hole 2xØ68/70mm
- 850°C, 400V~
- in accordance with IEC 60670-1
- halogen free

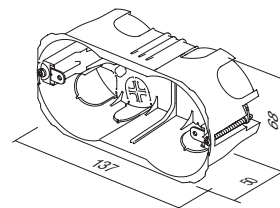

KUTI DREJTKËNDORE MUR BOSH VM7



HM70

- madhësia 7M, thellësia 49 mm
- vrima e prerjes 2xØ68/120mm
- 850°C, 400V~
- në përputhje me IEC 60670-1
- pa halogjenë

RECTANGULAR BOX HOLLOW WALL VM7

- size 7M, depth 49mm
- cutting hole 2xØ68/120mm
- 850°C, 400V~
- in accordance with IEC 60670-1
- halogen free

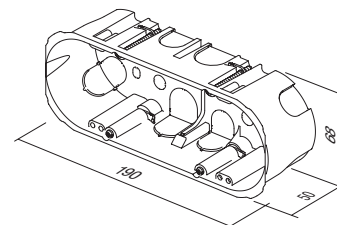

KUTI DREJTKËNDORE MUR BOSH VM72



HM72

- madhësia 2x7M, thellësia 63mm
- 850°C, 400V~
- në përputhje me IEC 60670-1
- pa halogjenë





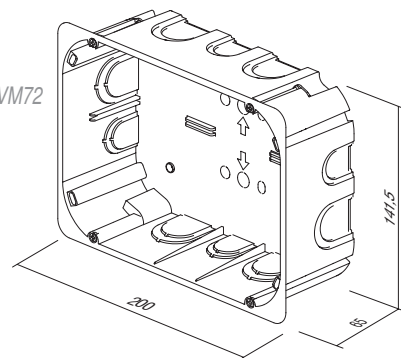

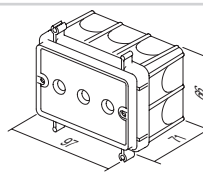

RECTANGULAR BOX HOLLOW WALL VM72

- size 2x7M, depth 63mm
- 850°C, 400V~
- in accordance with IEC 60670-1
- halogen free

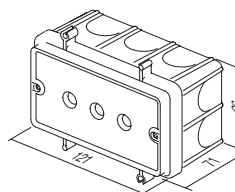

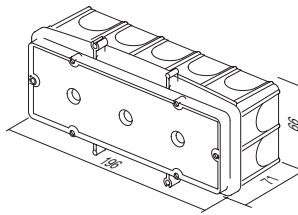

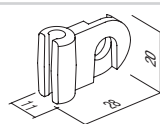
## R E C T A N G U L A R   B O X E S

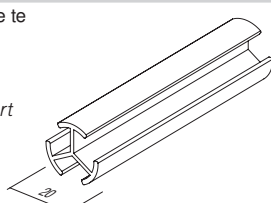
	BM30	<b>KUTI DREJTKËNDORE BETON BM3</b> - madhësia 3M, thellësia 60mm - 650°C, 400V~ - në përputhje me IEC 60670-1 - pa halogjenë <i>RECTANGULAR BOX CONCRETE BM3</i> - size 3M, depth 60mm - 650°C, 400V~ - in accordance with IEC 60670-1 - halogen free	
	BM40	<b>KUTI DREJTKËNDORE BETON BM4</b> - madhësia 4M, thellësia 60mm - 650°C, 400V~ - në përputhje me IEC 60670-1 - pa halogjenë <i>RECTANGULAR BOX CONCRETE BM4</i> - size 4M, depth 60mm - 650°C, 400V~ - in accordance with IEC 60670-1 - halogen free	
	BM70	<b>KUTI DREJTKËNDORE BETON BM7</b> - madhësia 7M, thellësia 60mm - 650°C, 400V~ - në përputhje me IEC 60670-1 - pa halogjenë <i>RECTANGULAR BOX CONCRETE BM7</i> - size 7M, depth 60mm - 650°C, 400V~ - in accordance with IEC 60670-1 - halogen free	
	BM80	<b>KAPËSE FIKSUESE E KOMBINUAR BM</b> - për fiksimin e shpejtë të kutive drejtkëndore BM në shufra përforcuese - i përshtatshëm për diametër shufre deri në Ø8mm <i>FIXING COMBI-CLIP BM</i> - for fast fixation of BM rectangular boxes on reinforcing bar - suitable for bar diameter up to Ø8mm	
	BM82	<b>PROFIL DISTANCUES PËR KUTITË PM</b> - për suportin e kutive BM me kundër-suport kutie te muri përballë - gjatësia l=1m, diametri Ø20mm <i>DISTANCE PROFIL FOR BOXES BM</i> - to support boxes BM with counter box support on opposite wall - length l=1m, diameter Ø20mm	

# K U T I T Ë D R E J T K Ë N D O R E



tullë / brick

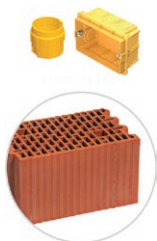

mure bosh / hollow walls



beton / concrete

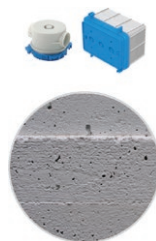

DM30		 <b>NM30</b>	<b>3M</b>
HM30			
BM30			
DM40		 <b>NM40</b>	<b>4M</b>
HM40			
BM40			
DM70		 <b>NM70</b>	<b>7M</b>
HM70			
BM70			
DM72		 <b>NM72</b>	<b>2x7M</b>
HM72			
DM30		 <b>NM32</b>	<b>2/3M</b>
HM30			
BM30			

## R E C T A N G U L A R   B O X E S

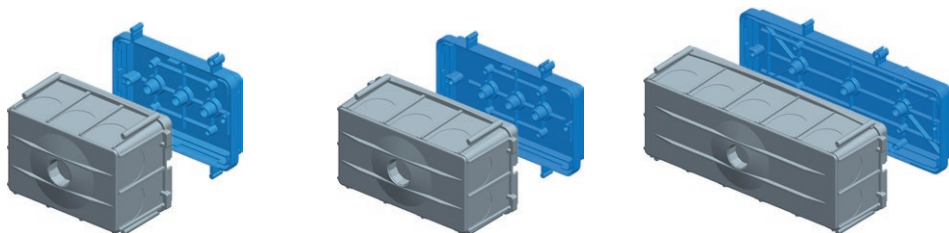

udhëzime për montimin /  
assembly instructions

1

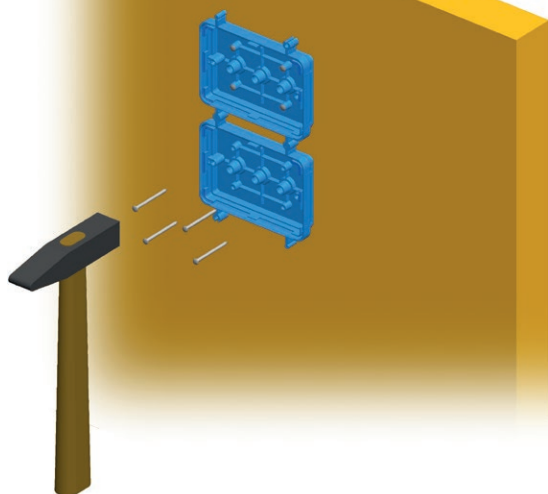

2

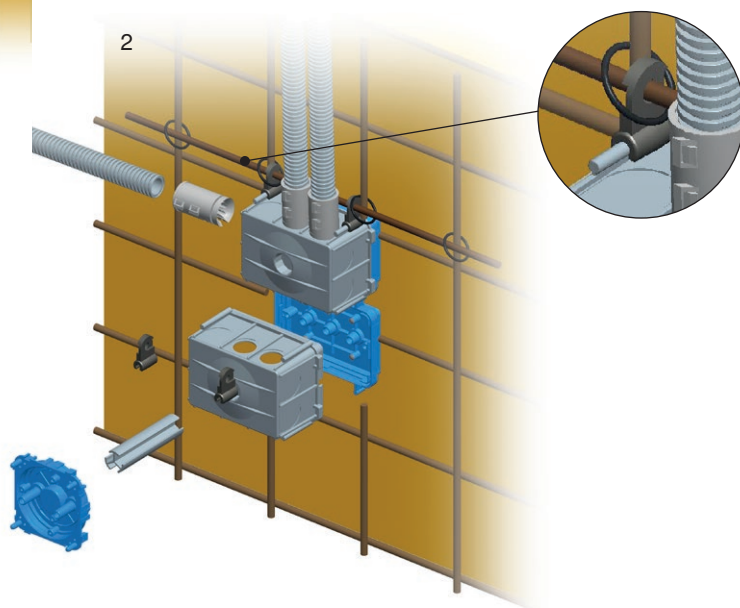

3

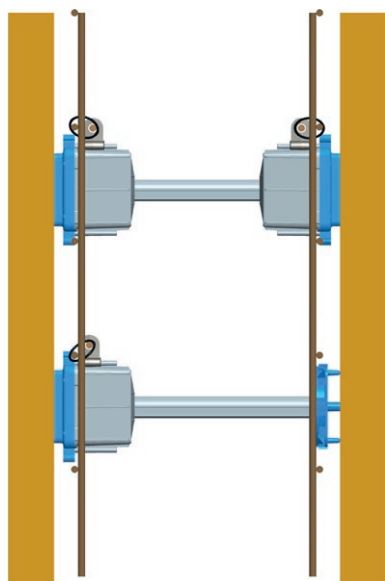

4

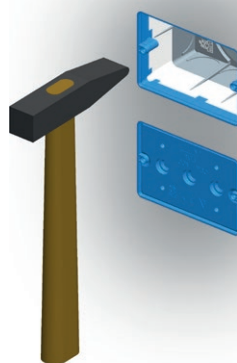

KUTI E RRUMBULLAKËT TULLË PËR LIDHJE DSM78



DW10

- Ø78, thellësia 40 mm
- 650°C, 500 V~
- në përputhje me IEC 60670-1 dhe IEC 60670-22
- pa halogjenë

CONNECTION ROUND BOX BRICK DSM78

- Ø78, depth 40mm
- 650°C, 500V~
- in accordance with IEC 60670-1 and IEC 60670-22
- halogen free

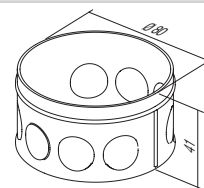

KUTI E RRUMBULLAKËT MUR BOSH SM78x45



HW10

- Ø78, thellësia 45mm
- vrima e prerjes Ø80
- 850°C, 400V~
- në përputhje me IEC 60670-1 dhe IEC 60670-22
- montim me kthetra
- pa halogjenë

CONNECTION ROUND BOX HOLLOW WALL SM78x45

- Ø78, depth 45mm
- cutting hole Ø80
- 850°C, 400V~
- in accordance with IEC 60670-1 and IEC 60670-22
- mounting with claws
- halogen free

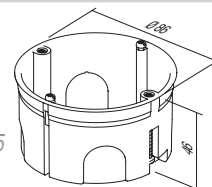

KAPAK DEKORATIV PËR KUTI SM78



DE23

- kapak dekorativ për kuti Ø78
- në përputhje me IEC 60670-1 dhe IEC 60670-22
- pa halogjenë

BOX COVER DECORATIVE SM78

- decorative cover for boxes Ø78
- in accordance with IEC 60670-1 and IEC 60670-22
- halogen free

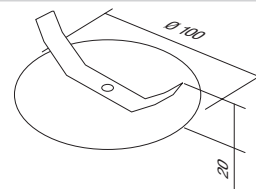

KAPAK MBROJTËS PËR KUTI 78



DE24

- kapak mbrojtës për kuti Ø78
- në përputhje me IEC 60670-1 dhe IEC 60670-22
- pa halogjenë

BOX COVER PROTECTIVE 78

- protective cover for box Ø78
- in accordance with IEC 60670-1 and IEC 60670-22
- halogen free

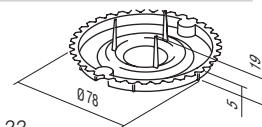

KUTI KATRORE TULLË PËR MUR BOSH SM105x105



HW20

- madhësia 105X105 mm, thellësia 50 mm
- vrimë prerjeje sipas shablonit bashkëngjitur
- 850°C, 400V~
- në përputhje me IEC 60670-1 dhe IEC 60670-22
- montim me kthetra
- pa halogjenë

CONNECTION SQUARE BOX HOLLOW WALL SM105x105

- size 105x105mm, depth 50mm
- cutting hole according to attached template
- 850°C, 400V~
- in accordance with IEC 60670-1 and IEC 60670-22
- mounting with claws
- halogen free

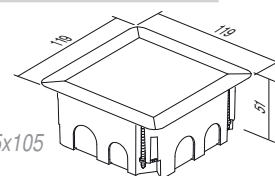





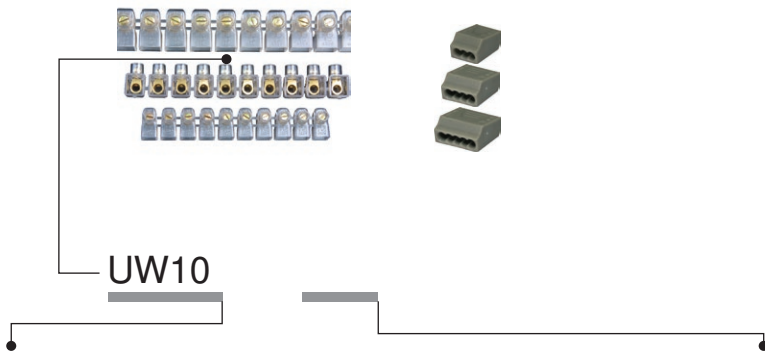

Iloji type	përshkrimi description	të dhënat teknike technical data	madhësia size	ngjyra colour
UW10	BLLOQE TERMINALESH ME 1 RADHË 1 ROW TERMINAL BLOCKS	2x2.5mm <sup>2</sup>	10P	<input checked="" type="checkbox"/> TS transparent transparent
UW11	BLLOQE TERMINALESH ME 1 RADHË 1 ROW TERMINAL BLOCKS	2x4mm <sup>2</sup>	10P	<input checked="" type="checkbox"/> CO ngjyra colour
UW12	BLLOQE TERMINALESH ME 1 RADHË 1 ROW TERMINAL BLOCKS	2x6mm <sup>2</sup>	10P	<input type="checkbox"/> WH e bardhë white
...	...	...	...	<input type="checkbox"/> GY gri grey

BLLOQE TERMINALESH ME 1 RADHË TË MBYLLURA



- 450 V~; 2x2.5 mm<sup>2</sup> ÷ 2x6mm<sup>2</sup>  
- termoplast PC, transparent  
- numri i poleve: 10

1 ROW TERMINAL BLOCKS CLOSED

- 450V~; 2x2.5mm<sup>2</sup> ÷ 2x6mm<sup>2</sup>  
- thermoplast PC, transparent  
- number of poles: 10

UW10TS	(NS12)	2x2.5mm <sup>2</sup>	10P
UW11TS	(NS12)	2x4mm <sup>2</sup>	10P
UW12TS	(NS12)	2x6mm <sup>2</sup>	10P

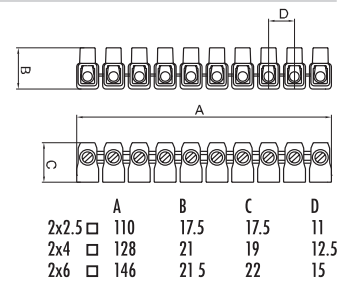

BLLOQE TERMINALESH ME 1 RADHË

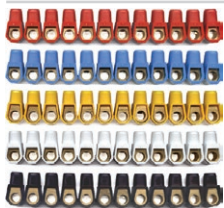

- 450 V~; 2x2.5 mm<sup>2</sup> ÷ 2x6mm<sup>2</sup>  
- termoplast PA  
- e disponueshme në ngjyra të ndryshme  
- numri i poleve: 12

1 ROW TERMINAL BLOCKS

- 450V~; 2x2.5mm<sup>2</sup> ÷ 2x6mm<sup>2</sup>  
- thermoplast PA  
- available in different colours  
- number of poles: 12

UW15CO	(NS12)	2x2.5mm <sup>2</sup>	12P
UW16CO	(NS12)	2x4mm <sup>2</sup>	12P
UW17CO	(NS12)	2x6mm <sup>2</sup>	12P

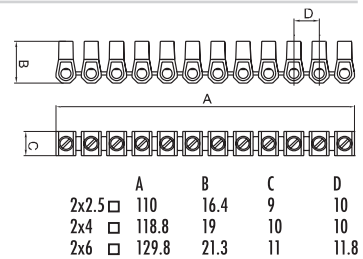

BLLOQE TERMINALESH ME 2 RADHË PP

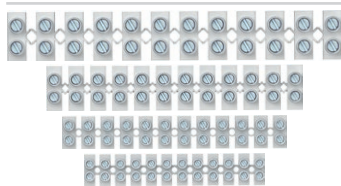

- 450 V~; 1 mm<sup>2</sup> ÷ 16 mm<sup>2</sup>  
- termoplast polipropilen PP, e bardhë  
- për temperaturat deri në 80°C  
- numri i poleve: 12

2 ROW TERMINAL BLOCKS PP

- 450V~; 1mm<sup>2</sup> ÷ 16mm<sup>2</sup>  
- thermoplast polypropylene PP, white  
- for temperatures up to 80°C  
- number of poles: 12

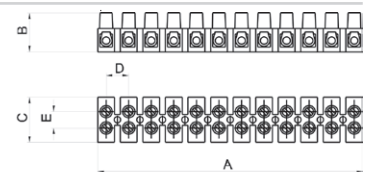

					A	B	C	D	E
UW29WHPP	1.0-4.0mm <sup>2</sup>	24 A	450 V		94,9	13	16,6	8,1	6,4
UW30WHPP	1.5-6.0mm <sup>2</sup>	32 A	450 V		116,5	14,9	18,9	10	7,3
UW31WHPP	2.5-10mm <sup>2</sup>	41 A	450 V		133,8	17,3	23,4	11,5	10
UW32WHPP	4-16mm <sup>2</sup>	76 A	450 V		174,5	20,7	25	15	11

## W I R I N G    A C C E S S O R I E S

## BLOQE TERMINALESH ME 2 RADHË PA

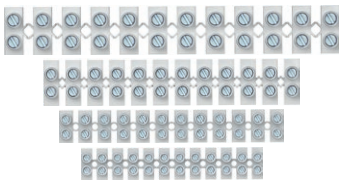

- 450 V~: 1 mm<sup>2</sup> ÷ 16 mm<sup>2</sup>
- termoplast poliamid PA, e bardhë
- për temperaturat deri në 110°C
- numri i poleve: 12

## 2 ROW TERMINAL BLOCKS PA

- 450V~; 1mm<sup>2</sup> ÷ 16mm<sup>2</sup>
- thermoplast polyamide PA, white
- for temperatures up to 110°C
- number of poles: 12

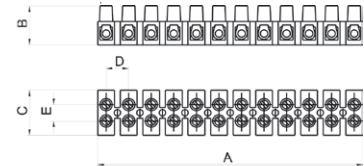

					A	B	C	D	E
UW25WHPA	1.0-4.0mm <sup>2</sup>	24 A	450 V		93,6	13,4	16,2	8	6,4
UW26WHPA	1.5-6.0mm <sup>2</sup>	32 A	450 V		117	15	18,6	10	7,3
UW27WHPA	2.5-10mm <sup>2</sup>	41 A	450 V		132,8	17,3	22,2	11,5	10
UW28WHPA	4-16mm <sup>2</sup>	76 A	450 V		173,9	20,8	25,2	15	11

## KONEKTORË PËR FUTJE TELASH



- 24 A 450 V~, termoplast PA, gri
- numri i poleve: 3÷8
- kontakte për futje telash 0,5÷1,5 mm<sup>2</sup>, për tela të fortë
- në përputhje me EN 60998-1

## PLUG-IN WIRE CONNECTORS

- 24A 450V~, thermoplast PA, grey
- number of poles: 3÷8
- plug-in contacts 0.5÷1.5mm<sup>2</sup>, for rigide wires
- in accordance with EN 60998-1

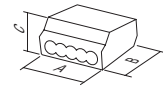

UW40GY	PC153	1.5mm <sup>2</sup>	3P	3P	A 12	B 18	C 9
UW41GY	PC155	1.5mm <sup>2</sup>	5P	5P	17	18	9
UW42GY	PC158	1.5mm <sup>2</sup>	8P	8P	26	18	9

## KONEKTORË PËR FUTJE TELASH



- 24 A 450 V~, termoplast PA, gri
- numri i poleve: 3÷5
- kontakte për futje telash 1,5÷2,5mm<sup>2</sup>, për tela të fortë
- në përputhje me EN 60998-1

## PLUG-IN WIRE CONNECTORS

- 24A 450V~, thermoplast PA, grey
- number of poles: 3÷5
- plug-in contacts 1.5÷2.5mm<sup>2</sup>, for rigide wires
- in accordance with EN 60998-1

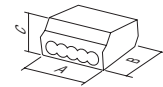

UW45GY	PC253	2.5mm <sup>2</sup>	3P	3P	A 14	B 19	C 9
UW46GY	PC254	2.5mm <sup>2</sup>	4P	4P	17	19	9
UW47GY	PC255	2.5mm <sup>2</sup>	5P	5P	21	19	9

## KONEKTOR PËR FUTJE TELASH



- 24 A 450 V~, termoplast PA, gri
- numri i poleve: 2 (tel i fortë)+1 (tel i butë)
- kontakte për futje telash 1,5÷2,5mm<sup>2</sup>
- në përputhje me EN 60998-1

## PLUG-IN WIRE CONNECTOR

- 24A 450V~, thermoplast PA, grey
- number of poles: 2 (rigide wire)+1 (soft wire)
- plug-in contacts 1.5÷2.5mm<sup>2</sup>
- in accordance with EN 60998-1

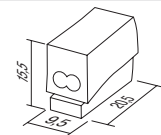

UW50WH	PC302	2.5mm <sup>2</sup>	2/P				
--------	-------	--------------------	-----	--	--	--	--



164



165



167

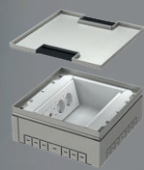

172



# SHPËRNDARJA

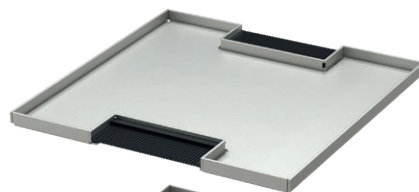

**TEM**



# K U T I C U B O I P 2 0 A C

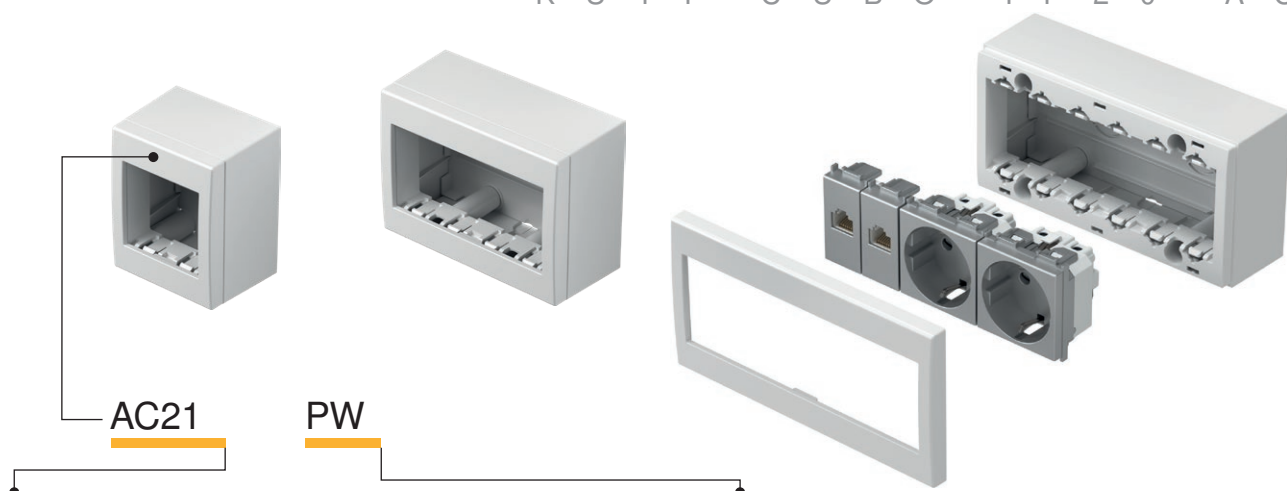

Iloji type	përshkrimi description	të dhënat teknike technical data	madhësia size	ngjyra colour
AC11	KUTI PËR MONTIM NË SIPËRFAQE NO CUBO ME KAPAK TË PASMË ANËSOR SURFACE MOUNT BOX WITH BACK SIDE COVER	IP20	1M	<input type="checkbox"/> PW e bardhë polare polar white <input type="checkbox"/> ES e argjendtë elox elox silver
AC21	KUTI PËR MONTIM NË SIPËRFAQE NO CUBO ME KAPAK TË PASMË ANËSOR SURFACE MOUNT BOX WITH BACK SIDE COVER	IP20	2M	<input type="checkbox"/> IW e bardhë fildishi ivory white <input type="checkbox"/> AT antracit anthracite <b>NEW</b>
AC41	KUTI PËR MONTIM NË SIPËRFAQE NO CUBO ME KAPAK TË PASMË ANËSOR SURFACE MOUNT BOX WITH BACK SIDE COVER	IP20	4M	<input type="checkbox"/> AT antracit anthracite <b>NEW</b>

## KUTI NO CUBO ME KAPAK TË PASMË ANËSOR IP20 1M



- AC11PW
- AC11ES
- AC11IW
- AC11AT

- kuti IP20 1M
- për montimin në sipërfaqe të elementeve
- e përshtatshme për çelësat SM
- në përputhje me EN 60669-1

BOX NO CUBO WITH BACK SIDE COVER IP20 1M  
 - box IP20 1M  
 - for surface mounting of elements  
 - suitable to SM switches  
 - in accordance with EN 60669-1



## KUTI NO CUBO ME KAPAK TË PASMË ANËSOR IP20 2M



- AC21PW
- AC21ES
- AC21IW
- AC21AT

- kuti IP20 2M
- për montimin në sipërfaqe të elementeve
- në përputhje me EN 60669-1, EN60884-1

BOX NO CUBO WITH BACK SIDE COVER IP20 2M  
 - box IP20 2M  
 - for surface mounting of elements  
 - in accordance with EN 60669-1, EN60884-1



## KUTI NO CUBO ME KAPAK TË PASMË ANËSOR IP20 4M



- AC41PW
- AC41ES
- AC41IW
- AC41AT

- kuti IP20 4M
- për montimin në sipërfaqe të elementeve
- në përputhje me EN 60669-1, EN60884-1

BOX NO CUBO WITH BACK SIDE COVER IP20 4M  
 - box IP20 4M  
 - for surface mounting of elements  
 - in accordance with EN 60669-1, EN60884-1



## KUTI NO CUBO ME KAPAK TË PASMË ANËSOR IP20 6M



- AC61PW
- AC61ES
- AC61IW
- AC61AT

- kuti IP20 6M
- për montimin në sipërfaqe të elementeve
- në përputhje me EN 60669-1, EN60884-1

BOX NO CUBO WITH BACK SIDE COVER IP20 6M  
 - box IP20 6M  
 - for surface mounting of elements  
 - in accordance with EN 60669-1, EN60884-1

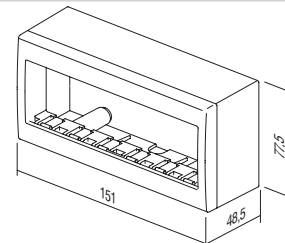
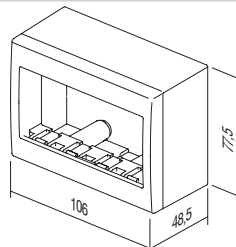
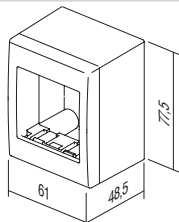
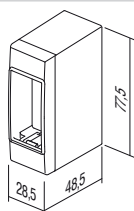

## B O X E S C U B O I P 5 5 A Q



lloji type	përshkrimi description	të dhënat teknike technical data	madhësia size	ngjyra colour
AQ20	KUTI ME MONTIM NË SIPËRFAQE TË JASHTME OUTDOOR SURFACE MOUNT BOX	IP55	2M	<input type="checkbox"/> PW e bardhë polare polar white
AQ22	KUTI ME MONTIM NË SIPËRFAQE TË JASHTME OUTDOOR SURFACE MOUNT BOX	IP55	2x2M	<input checked="" type="checkbox"/> GY gri grey
AQ30	KUTI ME MONTIM NË SIPËRFAQE TË JASHTME OUTDOOR SURFACE MOUNT BOX	IP55	3M	
AQ31	KUTI ME MONTIM NË SIPËRFAQE TË JASHTME OUTDOOR SURFACE MOUNT BOX	IP55	3M	

## KUTI NO CUBO IP55 2M



- AQ20PW
- AQ20GY

- kuti IP55 2M
- për montim në sipërfaqe
- IP55 për përdorim në zona me lagështirë
- në përputhje me CEI 23-48, EN 60670

## BOX NO CUBO IP55 2M

- box IP55 2M
- for surface mounting
- IP55 for usage in humid areas
- in accordance with CEI 23-48, EN 60670



## KUTI NO CUBO IP55 2x2M



- AQ22PW
- AQ22GY

- kuti IP55 2x2M
- për montim në sipërfaqe
- IP55 për përdorim në zona me lagështirë
- në përputhje me CEI 23-48, EN 60670

## BOX NO CUBO IP55 2x2M

- box IP55 2x2M
- for surface mounting
- IP55 for usage in humid areas
- in accordance with CEI 23-48, EN 60670



## KUTI NO CUBO IP55 3M



- AQ30PW
- AQ30GY

- kuti IP55 3M
- për montim në sipërfaqe
- IP55 për përdorim në zona me lagështirë
- në përputhje me CEI 23-48, EN 60670

## BOX NO CUBO IP55 3M

- box IP55 3M
- for surface mounting
- IP55 for usage in humid areas
- in accordance with CEI 23-48, EN 60670





- AQ21PW
- AQ21AT

KUTI PO CUBO IP55 2M

- kuti IP55 2M
- mund të kombinohet me të gjitha elementet funksionale të Modul
- për montim rrafsh
- IP55 për përdorim në zona me lagështirë
- në përputhje me CEI 23-48, EN 60670

BOX PO CUBO IP55 2M

- box IP55 2M
- can be combined with all Modul functional elements
- for flush mounting
- IP55 for usage in humid areas
- in accordance with CEI 23-48, EN 60670



- AQ31PW
- AQ31GY

KUTI PO CUBO IP55 3M

- kuti IP55 3M
- për montim rrafsh
- IP55 për përdorim në zona me lagështirë
- në përputhje me CEI 23-48, EN 60670

BOX PO CUBO IP55 3M

- box IP55 3M
- for flush mounting
- IP55 for usage in humid areas
- in accordance with CEI 23-48, EN 60670

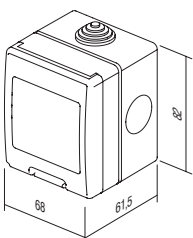

AQ20

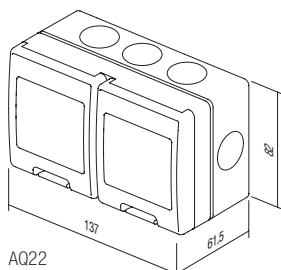

AQ22

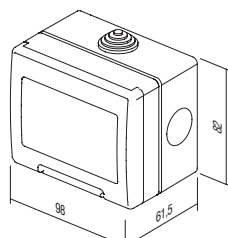

AQ30

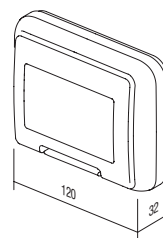

AQ31

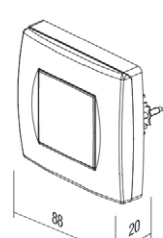

AQ21



## TRUNKING SYSTEM ALUMINIUM

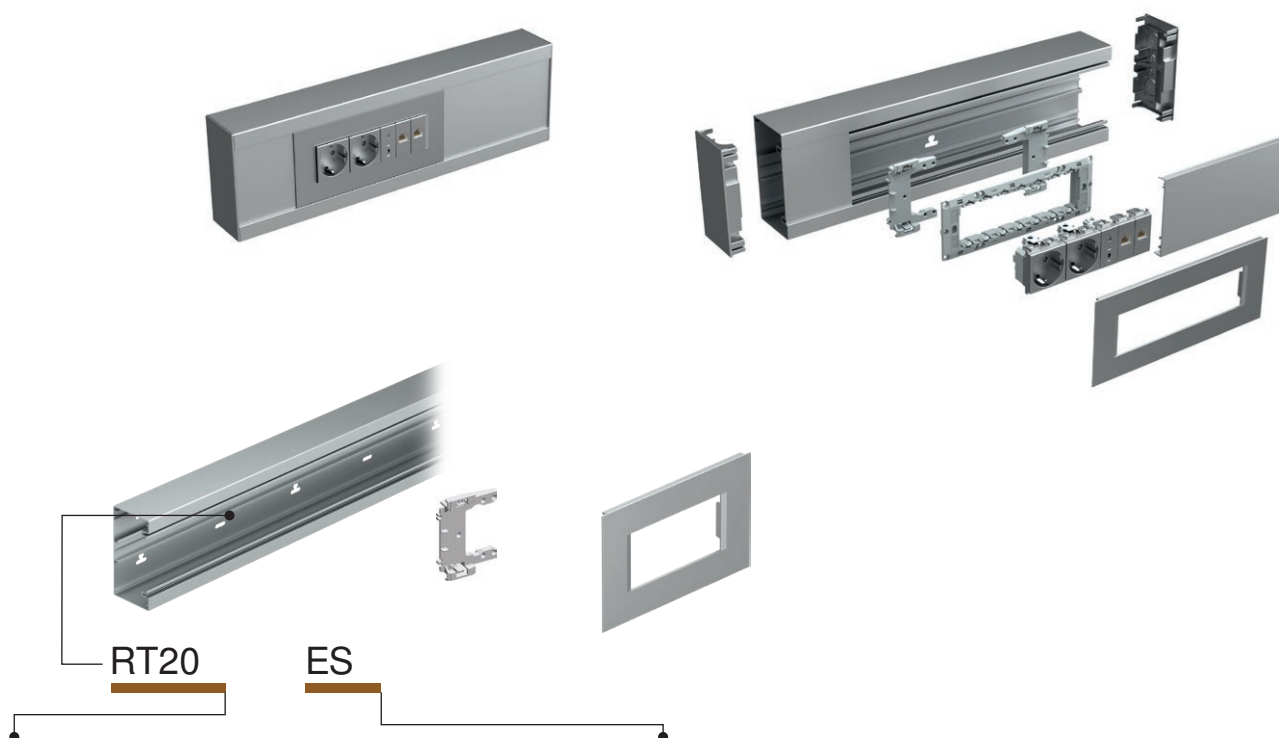

Iloji type	përshkrimi description	madhësia size	ngjyra colour
RT10	PËRSHTATËS MA 92 ADAPTER MA 92	/	■ ES e argjendtë elox elox silver-mat
RT12	KAPAK MBULUES MA 92 COVER PLATE MA 92	2/3M	□ PW e bardhë mat (RAL 9016) white-mat
RT14	KAPAK MBULUES MA 92 COVER PLATE MA 92	4M	
⋮	⋮	⋮	

## PËRSHTATËS MA 92



RT10

- përshtatës për fiksimin e kornizave të montimit 2/3M, 4M ose 7M në kanalina MA pa kuti
- secila kornizë montimi ka nevojë për dy përshtatës
- në përputhje me EN 50085-1

## ADAPTER MA 92

- adapter for fixing mounting frames 2/3M, 4M or 7M on MA trunking without box
- each mounting frame needs two adapters
- in accordance with EN 50085-1



## KAPAK MBULUES MA 92 2/3M



■ RT12ES  
□ RT12PW

- kapak mbulues dekorativ MA 2/3M
- në përputhje me EN 50085-1

## COVER PLATE MA 92 2/3M

- decorative cover plate MA 2/3M
- in accordance with EN 50085-1

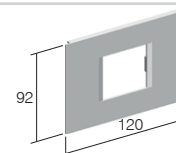

## KAPAK MBULUES MA 92 4M



■ RT14ES  
□ RT14PW

- kapak mbulues dekorativ MA 4M
- në përputhje me EN 50085-1

## COVER PLATE MA 92 4M

- decorative cover plate MA 4M
- in accordance with EN 50085-1

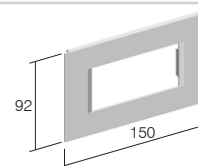

## KAPAK MBULUES MA 92 7M



■ RT17ES  
□ RT17PW

- kapak mbulues dekorativ MA 7M
- në përputhje me EN 50085-1

## COVER PLATE MA 92 7M

- decorative cover plate MA 7M
- in accordance with EN 50085-1

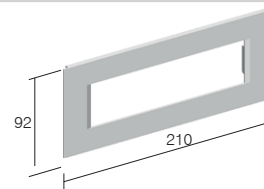

**BAZË PËR KANALINA MA 130x65**



- RT20ES
- RT20PW

- bazë për kanalina me profil alumini
- lartësia 130 mm, gjatësia 2 m
- DIN - formë shinë 35mm në fund
- në përputhje me EN 50085-1

**TRUNKING BASE MA 130x65**

- trunking base from extruded aluminium
- height 130mm, length 2m
- DIN - rail 35mm shape on bottom
- in accordance with EN 50085-1

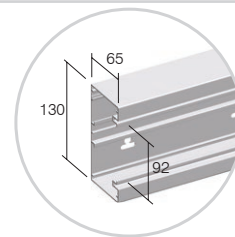

**BAZË PËR KANALINA MA 165x65**



- RT21ES
- RT21PW

- bazë për kanalina me profil alumini
- lartësia 165mm, gjatësia 2 m
- DIN - formë shinë 35mm në fund
- në përputhje me EN 50085-1

**TRUNKING BASE MA 165x65**

- trunking base from extruded aluminium
- height 165mm, length 2m
- DIN - rail 35mm shape on bottom
- in accordance with EN 50085-1

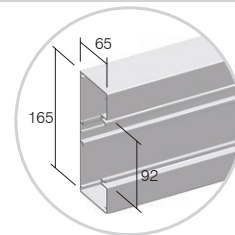

**KAPAK I PËRPARMË MA 92**



- RT25ES
- RT25PW

- kapak i përparmë prej profili alumini
- lartësia 92mm, gjatësia 2 m
- në përputhje me EN 50085-1

**FRONT COVER MA 92**

- front cover from extruded aluminium
- height 92mm, length 2m
- in accordance with EN 50085-1

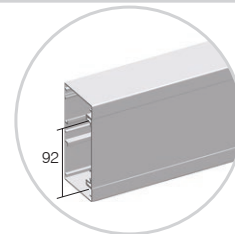

**RAFT KABLLOSH MA 43**



RT30

- raft kabllosh prej polimeresh
- thellësia 43mm, gjatësia 2 m
- në përputhje me EN 50085-1

**CABLE SHELF MA 43**

- cable shelf from extruded polymer
- depth 43mm, length 2m
- in accordance with EN 50085-1

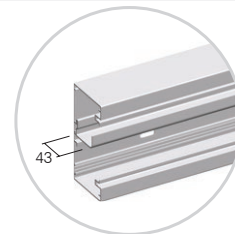

**RAFT KABLLOSH MA 43 AL**



RT31

- raft kabllosh prej profili alumini
- thellësia 43mm, gjatësia 2 m
- në përputhje me EN 50085-1

**CABLE SHELF MA 43 AL**

- cable shelf from extruded aluminium
- depth 43mm, length 2m
- in accordance with EN 50085-1

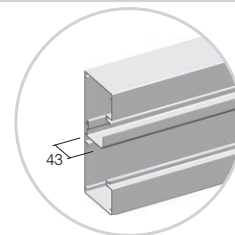

**RAFT KABLLOSH MA 43 AL DYSH**



RT32

- raft i dyfishtë kabllosh prej profili alumini
- thellësia 43mm, gjatësia 2 m
- në përputhje me EN 50085-1

**CABLE SHELF MA 43 AL DOUBLE**

- double cable shelf from extruded aluminium
- depth 43mm, length 2m
- in accordance with EN 50085-1

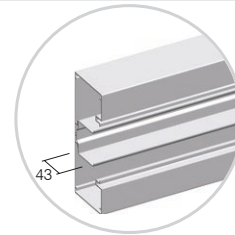

## T R U N K I N G   S Y S T E M   A L U M I N I U M

## ELEMENT FUNDOR BLOKUES MA 130x65



- RT35ES
- RT35PW

- element fundor bllokues prej polimeri
- lartësia 130mm
- në përputhje me EN 50085-1

*STOP END MA 130x65*

- stop end element from polymer
- height 130mm
- in accordance with EN 50085-1

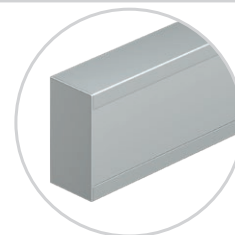

## ELEMENT FUNDOR BLOKUES MA 165x65



- RT36ES
- RT36PW

- element fundor bllokues prej metali
- lartësia 165mm
- në përputhje me EN 50085-1

*STOP END MA 165x65*

- stop end element from metal
- height 165mm
- in accordance with EN 50085-1

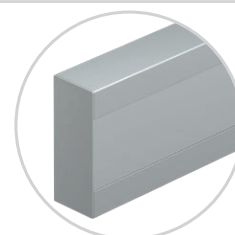

## SET PJESË BASHKUESE MA 65



RT38

- pjesë bashkuese prej polimeri
- seti përmban dy pjesë dhe vida
- në përputhje me EN 50085-1

*SET JOINING PIECE MA 65*

- joining piece from polymer
- set contains two pieces and screws
- in accordance with EN 50085-1

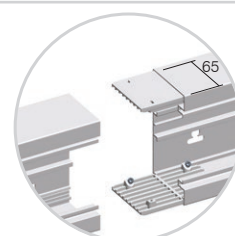

## KËND UNIVERSAL MA 130x65



- RT40ES
- RT40PW

- element këndor universal
- lartësia 130mm
- në përputhje me EN 50085-1

*UNIVERSAL CORNER MA 130x65*

- universal corner element
- height 130mm
- in accordance with EN 50085-1

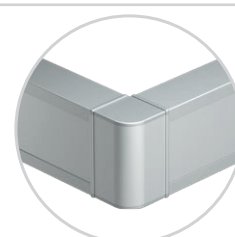

## KËND UNIVERSAL MA 165x65

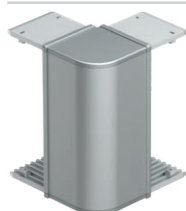

- RT41ES
- RT41PW

- element këndor universal
- lartësia 165mm
- në përputhje me EN 50085-1

*UNIVERSAL CORNER MA 165x65*

- universal corner element
- height 165mm
- in accordance with EN 50085-1



## PJESË TOKËZIMI MA 2x A6.3



RT42

- pjesë tokëzimi për tokëzimin e bazës së kanalit dhe kapakut të përparmë
- në përputhje me EN 50085-1

*EARTHING PIECE MA 2x A6.3*

- earthing piece for earthing of trunking base and front cover
- in accordance with EN 50085-1

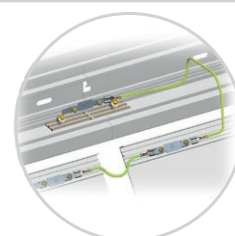

## BËRRYL L MA 130x65 / 130



- RT43ES
- RT43PW

- bërryl universal L prej alumini
- lartësia 130 mm, gjatësia 400mm
- lidhje në MA 130x65
- në përputhje me EN 50085-1

*L-BEND MA 130x65 / 130*

- universal L bend element from aluminium
- height 130mm, length 400mm
- connection on MA 130x65
- in accordance with EN 50085-1

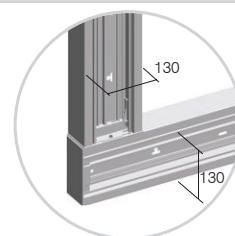

**BËRRYL L MA 165x65 / 130**



- RT44ES
- RT44PW

- bërryl universal L prej alumini
- lartësia 165mm, gjatësia 400mm
- lidhje në MA 130x65
- në përputhje me EN 50085-1

- L-BEND MA 165x65 / 130*
- universal L bend element from aluminium
  - height 165mm, length 400mm
  - connection on MA 130x65
  - in accordance with EN 50085-1

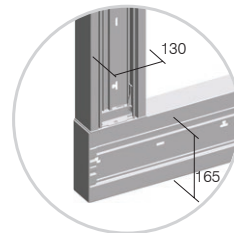

**BËRRYL L MA 165x65 / 165**



- RT47ES
- RT47PW

- bërryl universal L prej alumini
- lartësia 165mm, gjatësia 400mm
- lidhje në MA 165x65
- në përputhje me EN 50085-1

- L-BEND MA 165x65 / 165*
- universal L bend element from aluminium
  - height 165mm, length 400mm
  - connection on MA 165x65
  - in accordance with EN 50085-1

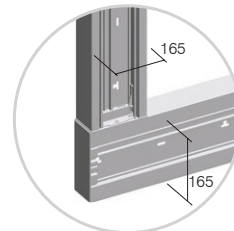

**BËRRYL T MA 130x65 / 130**



- RT45ES
- RT45PW

- bërryl universal T prej alumini
- lartësia 130 mm, gjatësia 400mm
- lidhje në MA 130x65
- në përputhje me EN 50085-1

- T-BEND MA 130x65 / 130*
- universal T bend element from aluminium
  - height 130mm, length 400mm
  - connection on MA 130x65
  - in accordance with EN 50085-1

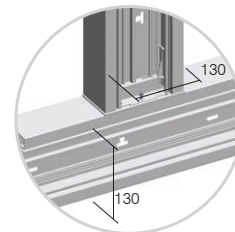

**BËRRYL T MA 165x65 / 130**

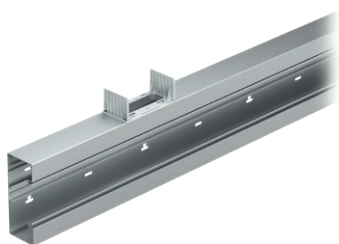

- RT46ES
- RT46PW

- bërryl universal T prej alumini
- lartësia 165mm, gjatësia 400mm
- lidhje në MA 130x65
- në përputhje me EN 50085-1

- T-BEND MA 165x65 / 130*
- universal T bend element from aluminium
  - height 165mm, length 400mm
  - connection on MA 130x65
  - in accordance with EN 50085-1

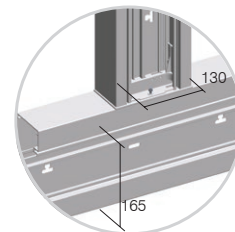

**BËRRYL T MA 165x65 / 165**

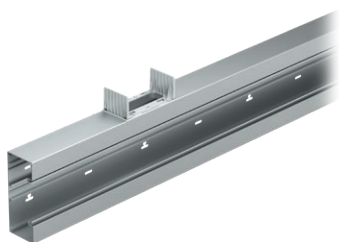

- RT48ES
- RT48PW

- bërryl universal T prej alumini
- lartësia 165mm, gjatësia 400mm
- lidhje në MA 165x65
- në përputhje me EN 50085-1

- T-BEND MA 165x65 / 165*
- universal T bend element from aluminium
  - height 165mm, length 400mm
  - connection on MA 165x65
  - in accordance with EN 50085-1

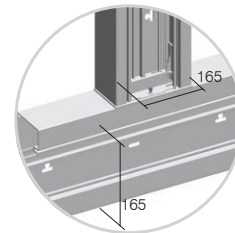

Kanalina MA bazohet në sistem modular dhe krijon kombinime elementesh 2M, 4M ose 7M

*MA trunking is based on modular system making 2M, 4M or 7M combinations of elements*

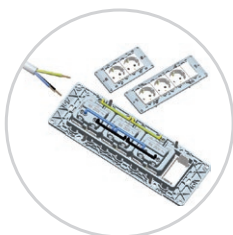

Në Modul ne ofrojmë elemente speciale për instalim të shpejtë

*In Modul we provide special elements for quick installation*

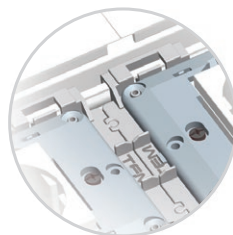

Me Përshtatësin MA ofrohet pozicionimi ekzakt pa përpjekje shtesë

*With Adapter MA exact positioning without extra effort is provided*

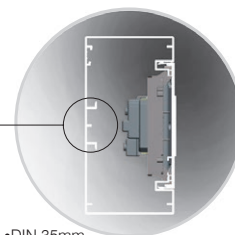

Montimi pa kuti nënkupton më shumë hapësirë për kablot, forma e bazës me shinë DIN EN-60715

*Mounted without box means more space for cables, DIN-rail base shape EN-60715*



# T R U N K I N G   S Y S T E M   A L U M I N I U M



## PLLAKËZ FIKSUESE MA NJËSHE 130x65



- RT50ES
- RT50PW

- pllakë fiksuese për fiksimin e bazës së kanalitës MA130 në dysheme dhe/ose në tavan
- në përputhje me EN 50085-1

### FIXING PLATE MA SINGLE 130x65

- fixing plate for fixing trunking base MA130 on the floor and/or on the ceiling
- in accordance with EN 50085-1



- RT51ES
- RT51PW

## PLLAKËZ FIKSUESE MA DYSHE 130x65

- pllakëz fiksuese për fiksimin e dy bazave të kanalitës MA130 në dysheme dhe/ose në tavan
- në përputhje me EN 50085-1

### FIXING PLATE MA DOUBLE 130x65

- fixing plate for fixing two trunking bases MA130 on the floor and/or on the ceiling
- in accordance with EN 50085-1



- RT52ES
- RT52PW

## KABINË SHËRBIMI MA 130x65x500

- kabinetë shërbimi MA
- lartësia 500mm
- kornizë montimi 7M e përfshirë
- në përputhje me EN 50085-1

### SERVICE POST MA 130x65x500

- service post MA
- height 500mm
- mounting frame 7M included
- in accordance with EN 50085-1



- RT53ES
- RT53PW

## KABINË SHËRBIMI MA DYSHE 130x130x500

- kabinetë shërbimi MA dyshe
- lartësia 500mm
- korniza montimi 7M të përfshira
- në përputhje me EN 50085-1

### SERVICE POST MA DOUBLE 130x130x500

- service post MA double
- height 500mm
- mounting frames 7M included
- in accordance with EN 50085-1

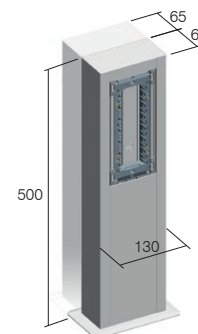

Ndërthurja e kablos / Cable intersection mm <sup>2</sup>	Prerje e tërthortë e kablos / Cable cross-section (mm <sup>2</sup> )				
	1 tel / 1 wire	2 tela / 2 wires	3 tela / 3 wires	4 tela / 4 wires	5 tela / 5 wires
1,5	44	111	121	144	169
2,5	49	133	157	169	211
4	58	169	183	211	256
6	68	196	225	256	307

Kanalina / Trunk	Kapaciteti i kanalitës / Trunk capacity			
	MA 130x65 bosh / empty	MA 130x65 me çelësat dhe prizat Modul / with Modul switches and sockets	MA 165x65 bosh / empty	MA 130x65 me çelësat dhe prizat Modul / with Modul switches and sockets
kapaciteti capacity max ø	7600 mm <sup>2</sup> 54 mm	5500 mm <sup>2</sup> 2x42 mm	9900 mm <sup>2</sup> 54 mm	7800 mm <sup>2</sup> 2x42 mm



# K U T I D Y S H E M E J E M T

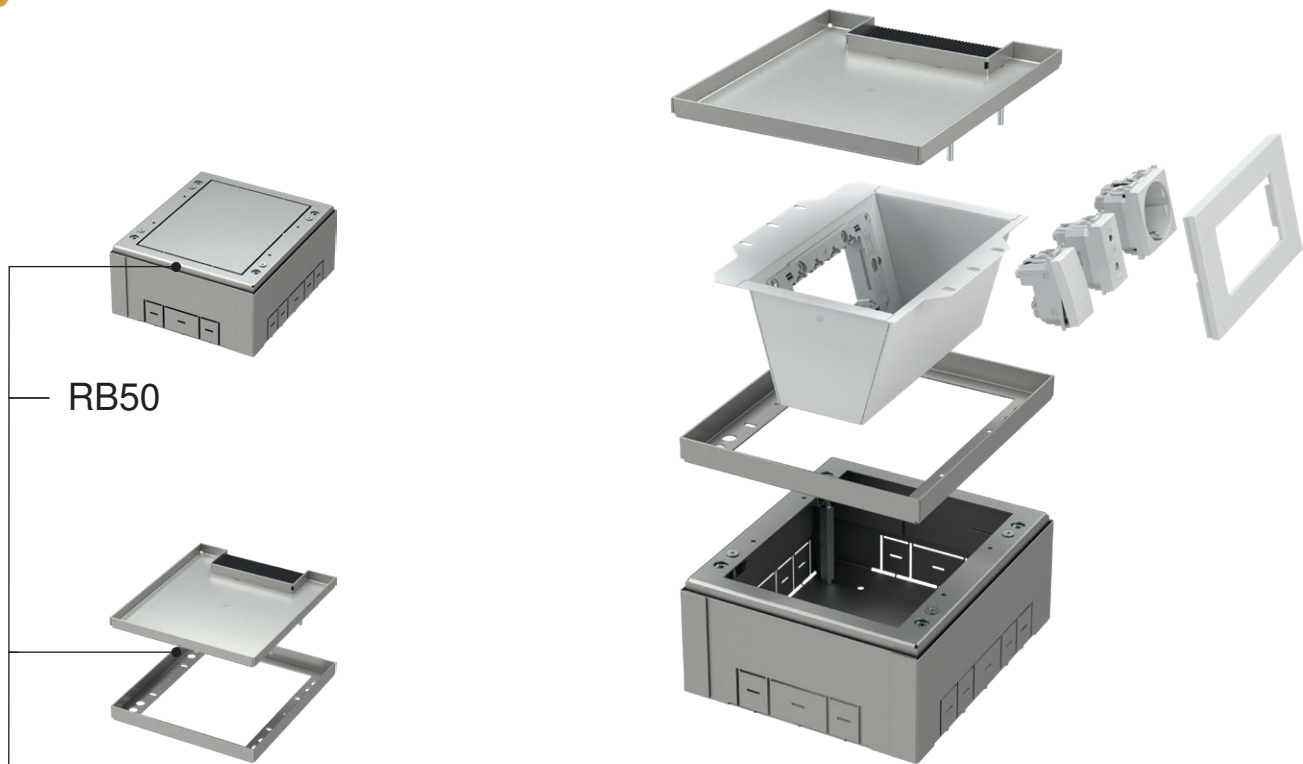

RB50

RB65S1

Iloji type	përshkrimi description	të dhënat teknike technical data
RB50	BAZË KUTIE DYSHEMEJE FLOOR BOX BASE	4M
RB65S1	INSERT PËR KUTI SHPËRNDARJEJE PËR DYSHEME FLOOR DISTRIBUTION BOX COVER	4M
RB60	INSERT PËR KUTI SHPËRNDARJEJE PËR DYSHEME INSERT FOR FLOOR DISTRIBUTION BOX	4M
·	·	·
·	·	·

	RB65S1	RB66S1	RB67S2	RB68S2
X	177	178	265	516,5
Y	200,5	265	265	265
Z	17,5	17,5	17,5	17,5

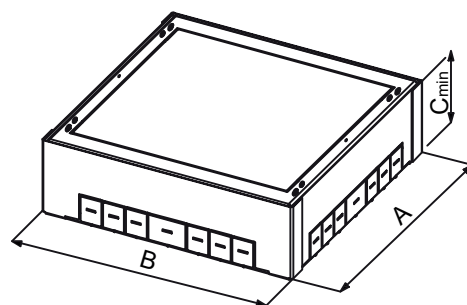
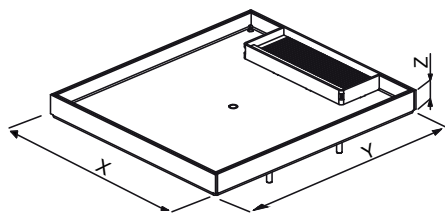

	RB50	RB51	RB52	RB53
A	208,5	273	273	273
B	182	182,5	269,5	521
C	83	83	83	83

## F L O O R   B O X E S   M T

## BAZË KUTIE DYSHEMEJE 4M



RB50

- bazë kutie dysHEMEJE 4M
- metalike, e galvanizuar
- për instalim në një dysHEME ose dysHEME dysHE
- dimensionet e montimit 208,5x182 mm, thellësia min. 83 mm
- lartësia e rregullueshme 83-128 mm
- në përputhje me standardet EN 5005-1 në EN 50085-2-2

*FLOOR BOX BASE 4M*

- floor box base 4M
- metal, galvanized
- for installation in a floor or double floor
- mounting dimensions 208.5x182mm, min. depth 83mm
- adjustable height 83-128mm
- In accordance with EN 5005-1 and EN 50085-2-2

## INSERT PËR KUTI SHPËRNDARJEJE PËR DYSHEME 4M



RB60

- insert për kuti shpërndarjeje 4M
- metalik, ngjyrë e bardhë RAL 9006
- korniza e montimit MODUL 4M e përfshirë
- në përputhje me standardet EN 5005-1 në EN 50085-2-2

*INSERT FOR FLOOR DISTRIBUTION BOX 4M*

- insert for floor box 4M
- metal, colour white RAL 9006
- mounting frame MODUL 4M included
- in accordance with EN 5005-1 and EN 50085-2-2

## KAPAK PËR KUTI SHPËRNDARJEJE PËR DYSHEME 4M



RB65S1

- kapak për kuti dysHEMEJE 4M
- metalik, i galvanizuar
- dimensionet e montimit 200,5x177 mm, thellësia 17,5 mm
- trashësia e dysHEMESË deri në 11,5 mm
- në përputhje me standardet EN 5005-1 në EN 50085-2-2

*FLOOR DISTRIBUTION BOX COVER 4M*

- floor box cover 4M
- metal, galvanized
- mounting dimensions 200.5x177mm, depth 17.5mm
- floor thickness up to 11.5mm
- in accordance with EN 5005-1 and EN 50085-2-2

## BAZË KUTIE DYSHEMEJE 7M



RB51

- bazë kutie dysHEMEJE 7M
- metalike, e galvanizuar
- për instalim në një dysHEME ose dysHEME dysHE
- dimensionet e montimit 273x182,5 mm, thellësia min. 83 mm
- lartësia e rregullueshme 83-128 mm
- në përputhje me standardet EN 5005-1 në EN 50085-2-2

*FLOOR BOX BASE 7M*

- floor box base 7M
- metal, galvanized
- for installation in a floor or double floor
- mounting dimensions 273x182.5mm, min. depth 83mm
- adjustable height 83-128mm
- in accordance with EN 5005-1 and EN 50085-2-2

## INSERT PËR KUTI SHPËRNDARJEJE PËR DYSHEME 7M



RB61

- insert për kuti dysHEMEJE 7M
- metalik, ngjyrë e bardhë RAL 9006
- korniza e montimit MODUL 7M e përfshirë
- në përputhje me standardet EN 5005-1 në EN 50085-2-2

*INSERT FOR FLOOR DISTRIBUTION BOX 7M*

- insert for floor box 7M
- metal, colour white RAL 9006
- mounting frame MODUL 7M included
- in accordance with EN 5005-1 and EN 50085-2-2

## KAPAK PËR KUTI SHPËRNDARJEJE PËR DYSHEME 7M



RB66S1

- kapak për kuti dysHEMEJE 7M
- metalik, i galvanizuar
- dimensionet e montimit 265x178 mm, thellësia 17,5 mm
- trashësia e dysHEMESË deri në 11,5 mm
- në përputhje me standardet EN 5005-1 në EN 50085-2-2

*FLOOR DISTRIBUTION BOX COVER 7M*

- floor box cover 7M
- metal, galvanized
- mounting dimensions 265x178mm, depth 17.5mm
- floor thickness up to 11.5mm
- in accordance with EN 5005-1 and EN 50085-2-2



RB52

**BAZË KUTIE DYSHEMEJE 2X7M**

- bazë kutie dyshemeje 2X7M
- metalike, e galvanizuar
- për instalim në një dysheme ose dysheme dyshe
- dimensionet e montimit 273x269,5 mm, thellësia min. 83 mm
- lartësia e rregullueshme 83-128 mm
- në përputhje me standardet EN 5005-1 në EN 50085-2-2

**FLOOR BOX BASE 2X7M**

- floor box base 2X7M
- metal, galvanized
- for installation in a floor or double floor
- mounting dimensions 273x269.5mm, min. depth 83mm
- adjustable height 83-128mm
- in accordance with EN 5005-1 and EN 50085-2-2



RB62

**INSERT PËR KUTI SHPËRNDARJEJE PËR DYSHEME 2X7M**

- insert për kuti dyshemeje 2x7M
- metalik, ngjyrë e bardhë RAL 9006
- kornizat e montimit MODUL 2x7M të përfshira
- në përputhje me standardet EN 5005-1 në EN 50085-2-2

**INSERT FOR FLOOR DISTRIBUTION BOX 2X7M**

- insert for floor box 2x7M
- metal, colour white RAL 9006
- mounting frames MODUL 2x7M included
- in accordance with EN 5005-1 and EN 50085-2-2



RB67S2

**KAPAK PËR KUTI SHPËRNDARJEJE PËR DYSHEME 2X7M**

- kapak për kuti dyshemeje 2x7M
- metalik, i galvanizuar
- dimensionet e montimit 265x265 mm, thellësia 17,5 mm
- trashësia e dyshemesë deri në 11,5 mm
- në përputhje me standardet EN 5005-1 në EN 50085-2-2

**FLOOR DISTRIBUTION BOX COVER 2X7M**

- floor box cover 2x7M
- metal, galvanized
- mounting dimensions 265x265mm, depth 17.5mm
- floor thickness up to 11.5mm
- in accordance with EN 5005-1 and EN 50085-2-2

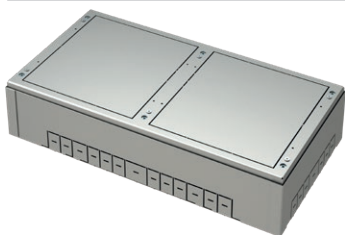

RB53

**BAZË KUTIE DYSHEMEJE 4X7M**

- bazë kutie dyshemeje 4X7M
- metalike, e galvanizuar
- për instalim në një dysheme ose dysheme dyshe
- dimensionet e montimit 273x521 mm, thellësia min. 83 mm
- lartësia e rregullueshme 83-128 mm
- në përputhje me standardet EN 5005-1 në EN 50085-2-2

**FLOOR BOX BASE 4X7M**

- floor box base 4X7M
- metal, galvanized
- for installation in a floor or double floor
- mounting dimensions 273x521mm, min. depth 83mm
- adjustable height 83-128mm
- in accordance with EN 5005-1 and EN 50085-2-2



RB62

**INSERT PËR KUTI SHPËRNDARJEJE PËR DYSHEME 2X7M**

- insert për kuti dyshemeje 2x7M
- metalik, ngjyrë e bardhë RAL 9006
- kornizat e montimit MODUL 2x7M të përfshira
- në përputhje me standardet EN 5005-1 në EN 50085-2-2

**INSERT FOR FLOOR DISTRIBUTION BOX 2X7M**

- insert for floor box 2x7M
- metal, colour white RAL 9006
- mounting frames MODUL 2x7M included
- in accordance with EN 5005-1 and EN 50085-2-2



RB68S2

**KAPAK PËR KUTI SHPËRNDARJEJE PËR DYSHEME 4X7M**

- kapak për kuti dyshemeje 4x7M
- metalik, i galvanizuar
- dimensionet e montimit 265x516,5 mm, thellësia 17,5 mm
- trashësia e dyshemesë deri në 11,5 mm
- në përputhje me standardet EN 5005-1 në EN 50085-2-2

**FLOOR DISTRIBUTION BOX COVER 4X7M**

- floor box cover 4x7M
- metal, galvanized
- mounting dimensions 265x516.5mm, depth 17.5mm
- floor thickness up to 11.5mm
- in accordance with EN 5005-1 and EN 50085-2-2





RB55S1

lloji type	përshkrimi description	të dhënat teknike technical data
RB55S1	KUTI DYSHEMEJE ME KAPAK PËR DYSHEME DYSHE FLOOR BOX WITH COVER FOR DOUBLE FLOORS	4M
RB60	INSERT PËR KUTI SHPËRNDARJEJE PËR DYSHEME INSERT FOR FLOOR DISTRIBUTION BOX	4M
⋮	⋮	⋮

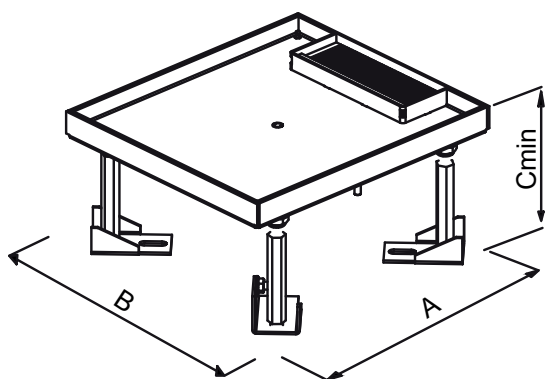

	RB55S1	RB56S1	RB57S2	RB58S2
A	200,5	265	265	265
B	177	178	265	516,5
C	100	100	100	100

## KUTI DYSHEMEJE ME KAPAK PËR DYSHEME DYSHE 4M



RB55S1

- bazë kutie dyshemeje 4M
- metalike, e galvanizuar
- dimensionet e montimit 200,5x177 mm, thellësia min. 100 mm
- lartësia e rregullueshme 100-145 mm
- trashësia e dyshemesë deri në 11,5 mm
- në përputhje me standardet EN 5005-1 në EN 50085-2-2

## FLOOR BOX WITH COVER FOR DOUBLE FLOORS 4M

- floor box base 4M
- metal, galvanized
- mounting dimensions 200.5x177mm, min. depth 100mm
- adjustable height 100-145mm
- floor thickness up to 11.5mm
- in accordance with EN 5005-1 and EN 50085-2-2

## INSERT PËR KUTI SHPËRNDARJEJE PËR DYSHEME 4M



RB60

- insert për kuti shpërndarjeje 4M
- metalik, ngjyrë e bardhë RAL 9006
- korniza e montimit MODUL 4M e përfshirë
- në përputhje me standardet EN 5005-1 në EN 50085-2-2

## INSERT FOR FLOOR DISTRIBUTION BOX 4M

- insert for floor box 4M
- metal, colour white RAL 9006
- mounting frame MODUL 4M included
- in accordance with EN 5005-1 and EN 50085-2-2

KUTI DYSHEMEJE ME KAPAK PËR DYSHEME DYSHE 7M



RB56S1

- bazë kutie dyshemeje 7M
- metalike, e galvanizuar
- dimensionet e montimit 265x178 mm, thellësia min. 100 mm
- lartësia e rregullueshme 100-145 mm
- trashësia e dyshemesë deri në 11.5 mm
- në përputhje me standardet EN 5005-1 në EN 50085-2-2

FLOOR BOX WITH COVER FOR DOUBLE FLOORS 7M

- floor box base 7M
- metal, galvanized
- mounting dimensions 265x178mm, min. depth 100mm
- adjustable height 100-145mm
- floor thickness up to 11.5mm
- in accordance with EN 5005-1 and EN 50085-2-2

INSERT PËR KUTI SHPËRNDARJEJE PËR DYSHEME 7M



RB61

- insert për kuti dyshemeje 7M
- metalik, ngjyrë e bardhë RAL 9006
- korniza e montimit MODUL 7M e përfshirë
- në përputhje me standardet EN 5005-1 në EN 50085-2-2

INSERT FOR FLOOR DISTRIBUTION BOX 7M

- insert for floor box 7M
- metal, colour white RAL 9006
- mounting frame MODUL 7M included
- in accordance with EN 5005-1 and EN 50085-2-2

KUTI DYSHEMEJE ME KAPAK PËR DYSHEME DYSHE 2X7M



RB57S2

- bazë kutie dyshemeje 2x7M
- metalike, e galvanizuar
- dimensionet e montimit 265x265 mm, thellësia min. 100 mm
- lartësia e rregullueshme 100-145 mm
- trashësia e dyshemesë deri në 11.5 mm
- në përputhje me standardet EN 5005-1 në EN 50085-2-2

FLOOR BOX WITH COVER FOR DOUBLE FLOORS 2X7M

- floor box base 2x7M
- metal, galvanized
- mounting dimensions 265x265mm, min. depth 100mm
- adjustable height 100-145mm
- floor thickness up to 11.5mm
- in accordance with EN 5005-1 and EN 50085-2-2

INSERT PËR KUTI SHPËRNDARJEJE PËR DYSHEME 2X7M



RB62

- insert për kuti dyshemeje 2x7M
- metalik, ngjyrë e bardhë RAL 9006
- kornizat e montimit MODUL 2x7M të përfshira
- në përputhje me standardet EN 5005-1 në EN 50085-2-2

INSERT FOR FLOOR DISTRIBUTION BOX 2X7M

- insert for floor box 2x7M
- metal, colour white RAL 9006
- mounting frames MODUL 2x7M included
- in accordance with EN 5005-1 and EN 50085-2-2

KUTI DYSHEMEJE ME KAPAK PËR DYSHEME DYSHE 4X7M



RB58S2

- bazë kutie dyshemeje 4x7M
- metalike, e galvanizuar
- dimensionet e montimit 265x516.5 mm, thellësia min. 100 mm
- lartësia e rregullueshme 100-145 mm
- trashësia e dyshemesë deri në 11.5 mm
- në përputhje me standardet EN 5005-1 në EN 50085-2-2

FLOOR BOX WITH COVER FOR DOUBLE FLOORS 4X7M

- floor box base 4x7M
- metal, galvanized
- mounting dimensions 265x516.5mm, min. depth 100mm
- adjustable height 100-145mm
- floor thickness up to 11.5mm
- in accordance with EN 5005-1 and EN 50085-2-2

INSERT PËR KUTI SHPËRNDARJEJE PËR DYSHEME 2X7M

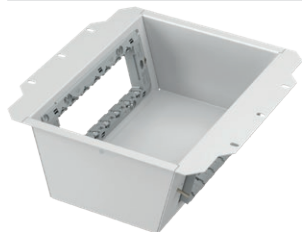

RB62

- insert për kuti dyshemeje 2x7M
- metalik, ngjyrë e bardhë RAL 9006
- kornizat e montimit MODUL 2x7M të përfshira
- në përputhje me standardet EN 5005-1 në EN 50085-2-2

INSERT FOR FLOOR DISTRIBUTION BOX 2X7M

- insert for floor box 2x7M
- metal, colour white RAL 9006
- mounting frames MODUL 2x7M included
- in accordance with EN 5005-1 and EN 50085-2-2

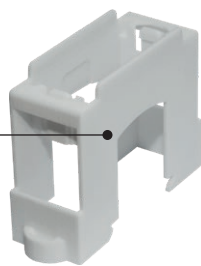
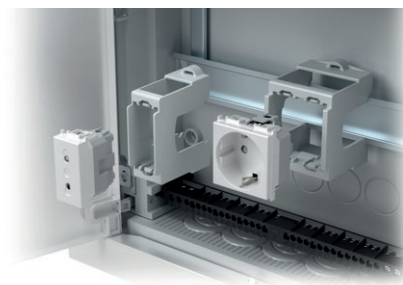
**RB10**

Iloji type	përshkrimi description	të dhënat teknike technical data
RB10	PËRSHTATËS PËR SHINË DIN ADAPTER FOR DIN RAIL	35mm 1M
RB11	PËRSHTATËS PËR SHINË DIN ADAPTER FOR DIN RAIL	35mm 2M
·	KUTI SHPËRNDARJEJE	·
·	·	·
·	·	·

**PËRSHTATËS PËR SHINË DIN 35 mm 1M**

**RB10**

- përshtatës MODUL 1M
- për shinë DIN 35 mm
- në përputhje me EN 50022

**ADAPTER FOR DIN RAIL 35mm 1M**

- adapter MODUL 1M
- for DIN rail 35mm
- in accordance with EN 50022

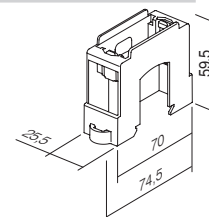

**PËRSHTATËS PËR SHINË DIN 35 mm 2M**

**RB11**

- përshtatës MODUL 2M
- për shinë DIN 35 mm
- në përputhje me EN 50022

**ADAPTER FOR DIN RAIL 35mm 2M**

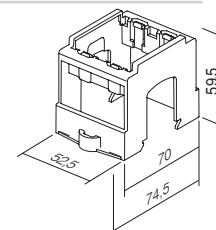
- adapter MODUL 2M
- for DIN rail 35mm
- in accordance with EN 50022



TEM

SWITCH  
LOGIQ





LOGIQ

LOGIQ  
BOLD



LOGIQ  
FLAT



LOGIQ  
PRIME





LOGIQ  

---

B O L D









LOGIQ  

---

FLAT









LOGIQ  

---

PRIME





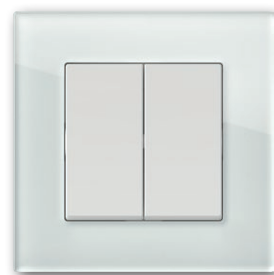

## Krijuar për çdo dhomë

Çelësat kanë linja universale që lënë shenjë si në ambiente moderne pune dhe në hapësira komode ndenjeje. Familja e çelësave LOGIQ ofron një zgjidhje të thjeshtë dhe logjike për çdo dëshirë tuajën.

*Made for every room*

*The switches have universal lines that make a mark in both modern work environments and cosy, comfortable living spaces. The LOGIQ family of switches offers a simple and logical solution for your every wish.*

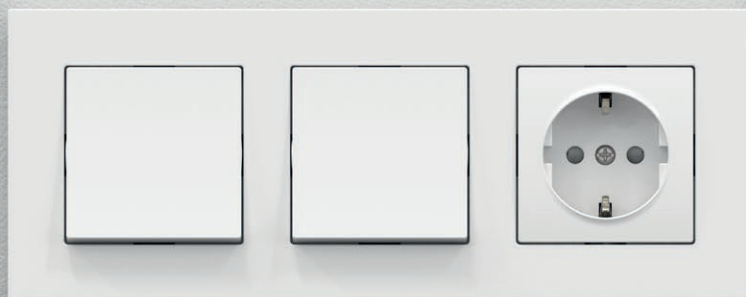

LOGIQ  
FLAT





LOGIQ  
PRIME



## Harmoni ngjyrash për çdo dhomë

Familja LOGIQ është krenare për gamën e saj logjike të nuancave të verifikuara dhe elegante të njohura dhe të pëlqyera nga përdoruesit tanë. Mos bëni kompromis, LOGIQ ju mbulon.

*Harmony of colours for every room*

*The LOGIQ family prides itself on its logical range of verified and elegant hues known and loved by our users. Do not compromise, LOGIQ has you covered.*

■ e zezë	<i>black</i>
■ antracit	<i>anthracite</i>
■ titan	<i>titanium</i>
□ e bardhë polare	<i>polar white</i>





LOGIQ  
B O L D



LOGIQ  
F L A T



LOGIQ  
P R I M E

## Imagjinatë pa kufi

Familja LOGIQ ju lejon të krijoni kombinimet tuaja. Për ta bërë kombinimin të thjeshtë, kemi krijuar një sistem të dobishëm që mbështet renditjen e linjave horizontale dhe vertikale. Sistemi i ashtuquajtur 55/55 ju lejon të përdorni të njëjtat elemente universale çdo herë.

### LIMITLESS IMAGINATION

*The LOGIQ family allows you to create your own combinations. To make combining simple, we have created a useful system that supports the sequencing of horizontal and vertical lines. The so-called 55/55 system allows you to use the same universal elements every time.*



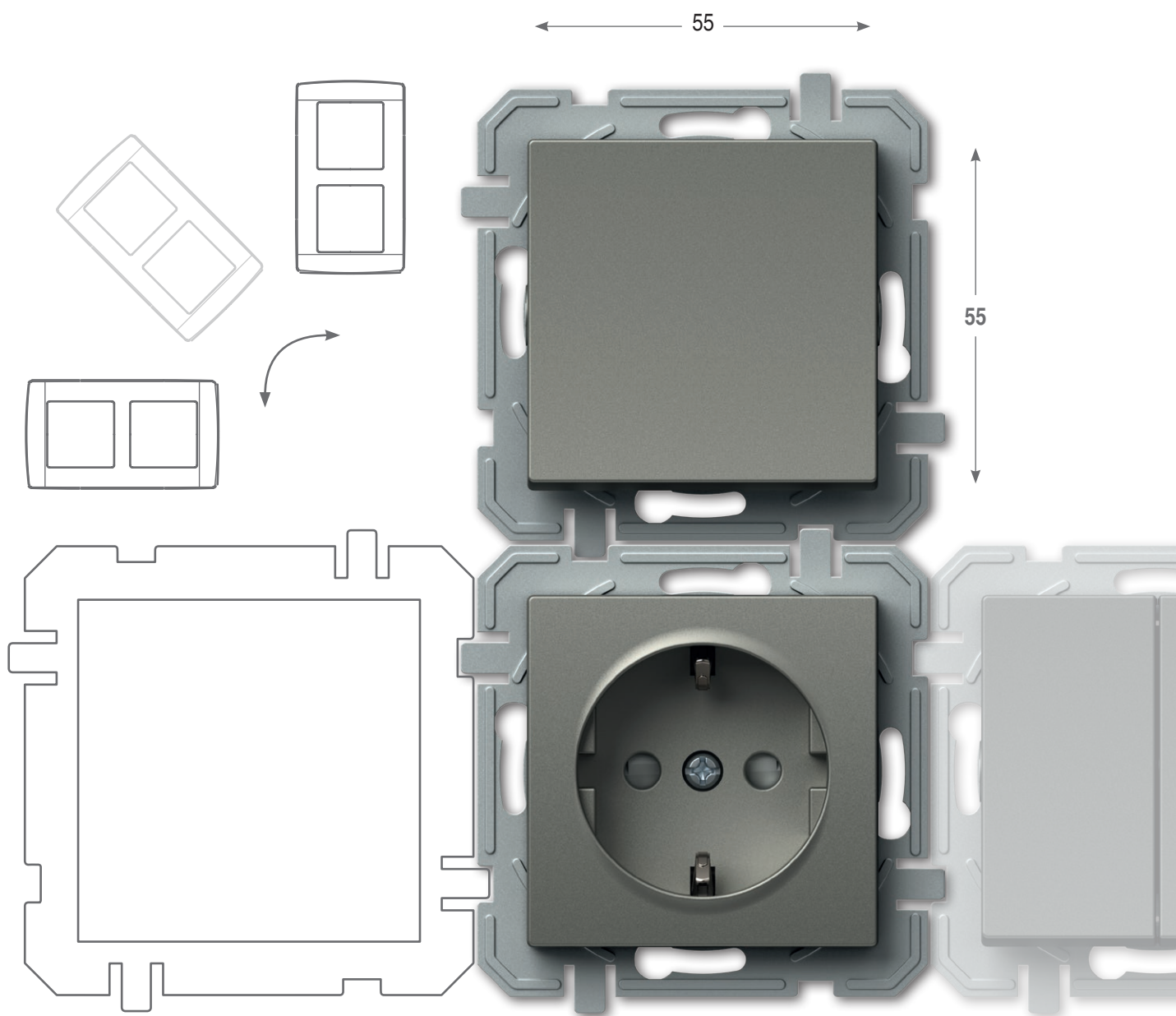



## Të thjeshtë edhe për personat më kërkues

Familja LOGIQ ofron elemente funksionale për çdo hapësirë dhe qëllim. Mund t'i përdorni këto produkte individualisht ose në sekuencë, horizontalisht ose vertikalisht.

Logjikisht!

*Simple for the most demanding*

*The LOGIQ family offers functional elements for every space and purpose. You can use these products individually or in a sequence, horizontally or vertically. Logically.*

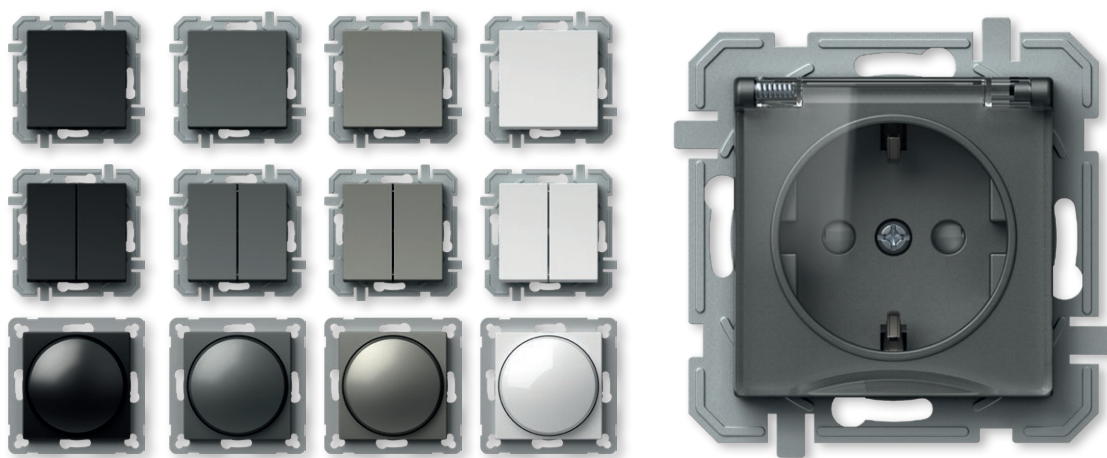

**Një gamë universals kapakësh mbulues dekorativë në të trija linjat e dizajnit – BOLD, FLAT dhe PRIME.**

*A universal layout of decorative cover plates in all three design lines – BOLD, FLAT and PRIME.*



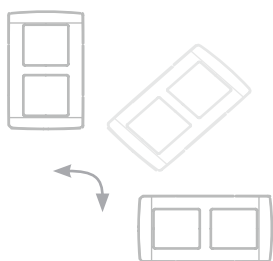

## Instalimi logjik

**LOGIQ është një zgjidhje për sistemin e kutive të standardizuara të rumbullakëta të instalimit. Ai mund të përdoret për instalime të thjeshta dhe të komplikuar, ndërtesa të reja dhe përshtatje. Sistemi karakterizohet nga kontakte për futje telash që kursejnë kohë gjatë instalimit të elementeve.**

### *Logical installation*

*LOGIQ is a solution for the system of standardized round installations boxes. It can be used for simple as well as more demanding installations, new buildings and adaptations. The system is characterised by plug-in contacts which save time during installation of elements.*

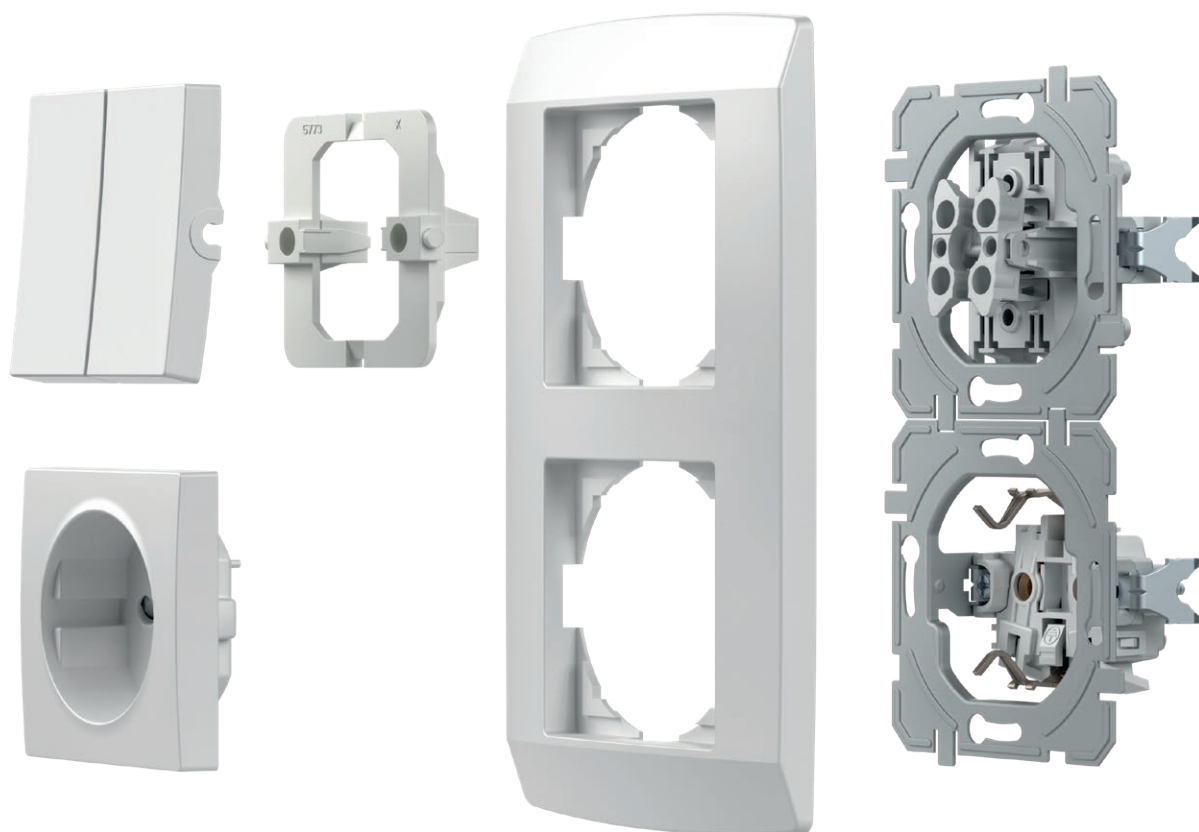

## Informacion i dobishëm

*Good to know*



Të gjitha prizat janë të pajisura me mbyllëse sigurie që garantojnë mbrojtjen e kontakteve nën tension.

*All the sockets are equipped with a safety shutters assuring the protection to live contacts.*



Dizajni i mirëmenduar i çelësit mundëson integrimin e thjeshtë të treguesit, edhe në një moment të mëvonshëm.

*The well-thought-out design of the switch enables the easy integration of the indication, including at a later time.*



Kontaktet prej aliazhi argjendi garantojnë komutimin e sigurt.

*Contacts made of silver alloy guarantee safe switching.*



Kontaktet për futjen e telave mundësojnë bashkim të shpejtë dhe të sigurt të telave. Dy tela me diametër të ndryshëm mund të bashkohen me të njëjtin kontakt.

*Plug-in contacts enable quick and reliable attachment of wires. Two wires of different diameters can be attached to the same contact.*



Kapëset fiksuese mundësojnë fiksime më të thellë (gjithashtu përmes pllakave qeramike etj.)

*Fixing claws enable deeper fixing (also through ceramic tiles, etc.)*



Kutitë e instalimit me montim të lehtë do t'ju lehtësojnë punën. Gjatësitë e duhura janë të garantuara.

*Easy-fitting installation boxes will make your work easier. Proper lengths are guaranteed.*



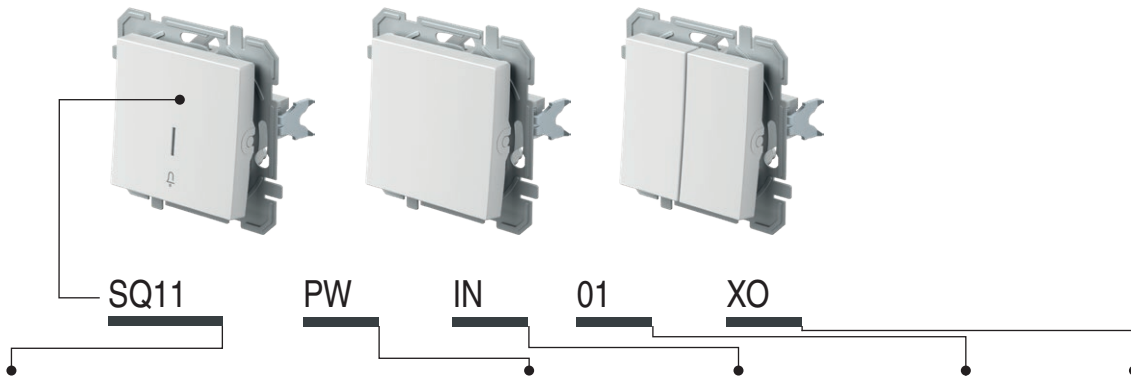

Iloji type	përshkrimi description	të dhënat teknike technical data	ngjyra colour	të dhënat opsionale 1 optional data 1	të dhënat opsionale 2 optional data 2	të dhënat opsionale 3 optional data 3
SQ10	ÇELËS ME 1 DREJTIM SWITCH 1WAY	10AX 250V~	<input type="checkbox"/> PW e bardhë polare polar white	NT neutral neutral	01	XO pa kapak mbulues without cover plate
SQ11	BUTON ME SHTYPJE ME 1 DREJTIM PUSH BUTTON 1WAY	10A 250V~	<input type="checkbox"/> TI titan titanium	IN treguesi indicator	02	
SQ22	ÇELËS 2-POLAR SWITCH 2POLE	16AX 250V~	<input type="checkbox"/> AT antracit anthracite	IN treguesi indicator	03	
...	...	...	<input type="checkbox"/> BK e zezë black			

ÇELËS ME 1 DREJTIM 10 AX 250 V~



- SQ10PWXO
- SQ10TIXO
- SQ10ATXO
- SQ10BKXO



- 10 AX 250 V~, Iloji SQ10  
 - në përputhje me EN 60669-1  
 - kontakte për futje telash 1,5-2,5 mm<sup>2</sup>  
 SWITCH 1WAY 10AX 250V~  
 - 10AX 250V~, type SQ10  
 - in accordance with EN 60669-1  
 - plug-in contacts 1.5-2.5mm<sup>2</sup>



ÇELËS ME 1 DREJTIM 10 AX 250 V~ \_\_ IN



- SQ10PWINXO
- SQ10TIINXO
- SQ10ATINXO
- SQ10BKINXO

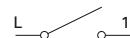

- tregues IN, pa llambë neoni  
 - 10 AX 250 V~, Iloji SQ10  
 - në përputhje me EN 60669-1  
 - kontakte për futje telash 1,5-2,5 mm<sup>2</sup>  
 SWITCH 1WAY 10AX 250V~ \_\_ IN  
 - IN indicator, without neon lamp  
 - 10AX 250V~, type SQ10  
 - in accordance with EN 60669-1  
 - plug-in contacts 1.5-2.5mm<sup>2</sup>



BUTON ME SHTYPJE ME 1 DREJTIM 10A 250 V~



- SQ11PWXO
- SQ11TIXO
- SQ11ATXO
- SQ11BKXO



- 10 A 250 V~, Iloji SQ11  
 - në përputhje me EN 60669-1  
 - kontakte për futje telash 1,5-2,5 mm<sup>2</sup>  
 PUSH BUTTON 1WAY 10A 250V~  
 - 10A 250V~, type SQ11  
 - in accordance with EN 60669-1  
 - plug-in contacts 1.5-2.5mm<sup>2</sup>



BUTON ME SHTYPJE ME 1 DREJTIM 10A 250V~ \_\_ IN 01



- SQ11PWIN01XO
- SQ11TIIN01XO
- SQ11ATIN01XO
- SQ11BKIN01XO

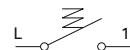

- tregues IN 01 me zile, pa llambë neoni  
 - 10 A 250 V~, Iloji SQ11  
 - në përputhje me EN 60669-1  
 - kontakte për futje telash 1,5-2,5 mm<sup>2</sup>  
 PUSH BUTTON 1WAY 10A 250V~ \_\_ IN 01  
 - IN 01 indicator bell, without neon lamp  
 - 10A 250V~, type SQ11  
 - in accordance with EN 60669-1  
 - plug-in contacts 1.5-2.5mm<sup>2</sup>



## BUTON ME SHYTPJE ME 1 DREJTIM 10 A 250 V~ \_\_ IN 02



- SQ11PWIN02XO
- SQ11TIIN02XO
- SQ11ATIN02XO
- SQ11BKIN02XO

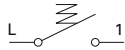

- dritë treguese IN 02, pa llambë neoni
- 10 A 250 V~, Iloji SQ11
- në përputhje me EN 60669-1
- kontakte për futje telash 1,5-2,5 mm<sup>2</sup>

## PUSH BUTTON 1WAY 10A 250V~ \_\_ IN 02

- IN 02 indicator light, without neon lamp
- 10A 250V~, type SQ11
- in accordance with EN 60669-1
- plug-in contacts 1.5-2.5mm<sup>2</sup>



## ÇELËS 2-POLAR 16 AX 250 V~ \_\_ IN 03



- SQ22PWIN03XO
- SQ22TIIN03XO
- SQ22ATIN03XO
- SQ22BKIN03XO

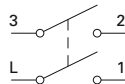

- IN 03 neutral 0-1, pa llambë neoni
- 16 AX 250 V~, Iloji SQ22
- në përputhje me EN 60669-1
- kontakte për futje telash 1,5-2,5 mm<sup>2</sup>

## SWITCH 2POLE 16AX 250V~ \_\_ IN 03

- IN 03 neutral 0-1, without neon lamp
- 16AX 250V~, type SQ22
- in accordance with EN 60669-1
- screw contacts 1.5-2.5mm<sup>2</sup>



## ÇELËS ME 2 VENDE - 1 DREJTIM 10 AX 250 V~



- SQ50PWXO
- SQ50TIXO
- SQ50ATXO
- SQ50BKXO

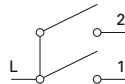

- 10 AX 250 V~, Iloji SQ50
- në përputhje me EN 60669-1
- kontakte për futje telash 1,5-2,5 mm<sup>2</sup>

## SWITCH 2GANG-1WAY 10AX 250V~

- 10AX 250V~, type SQ50
- in accordance with EN 60669-1
- plug-in contacts 1.5-2.5mm<sup>2</sup>



## BUTON ME SHYTPJE ME 2 VENDE - 1 DREJTIM 10 A 250 V



- SQ51PWXO
- SQ51TIXO
- SQ51ATXO
- SQ51BKXO

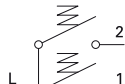

- 10 A 250 V~, Iloji SQ51
- në përputhje me EN 60669-1
- kontakte për futje telash 1,5-2,5 mm<sup>2</sup>

## PUSH BUTTON 2GANG-1WAY 10A 250V~

- 10A 250V~, type SQ51
- in accordance with EN 60669-1
- plug-in contacts 1.5-2.5mm<sup>2</sup>



## MBYLLËSE ÇELËSI 10 AX 250 V~ \_\_ NT 09



- SQ52PWNT09XO
- SQ52TINT09XO
- SQ52ATNT09XO
- SQ52BKNT09XO



- NT 09 neutral lart-poshtë
- 10 AX 250 V~, Iloji SQ52
- në përputhje me EN 60669-1
- kontakte për futje telash 1,5-2,5 mm<sup>2</sup>
- me bllokim mekanik

## SWITCH SHUTTERS 10AX 250V~ \_\_ NT 09

- NT 09 neutral up-down
- 10AX 250V~, type SQ52
- in accordance with EN 60669-1
- plug-in contacts 1.5-2.5mm<sup>2</sup>
- with mechanical interblock



## MBYLLËSE BUTONI ME SHYTPJE 10 A 250 V~ \_\_ NT 09



- SQ53PWNT09XO
- SQ53TINT09XO
- SQ53ATNT09XO
- SQ53BKNT09XO

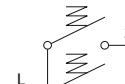

- NT 09 neutral lart-poshtë
- 10 A 250 V~, Iloji SQ53
- në përputhje me EN 60669-1
- kontakte për futje telash 1,5-2,5 mm<sup>2</sup>
- me bllokim mekanik

## PUSH BUTTON SHUTTERS 10A 250V~ \_\_ NT 09

- NT 09 neutral up-down
- 10A 250V~, type SQ53
- in accordance with EN 60669-1
- plug-in contacts 1.5-2.5mm<sup>2</sup>
- with mechanical interblock



## ÇELËS ME 2 DREJTIME 10 AX 250 V~



- SQ60PWXO
- SQ60TIXO
- SQ60ATXO
- SQ60BKXO

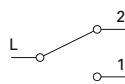

- 10 AX 250 V~, Iloji SQ60
- në përputhje me EN 60669-1
- kontakte për futje telash 1,5-2,5 mm<sup>2</sup>

## SWITCH 2WAY 10AX 250V~

- 10AX 250V~, type SQ60
- in accordance with EN 60669-1
- plug-in contacts 1.5-2.5mm<sup>2</sup>



ÇELËS DYSH ME 2 DREJTIME 10 A X 250 V~



- SQ63PWXO
- SQ63TIXO
- SQ63ATXO
- SQ63BKXO

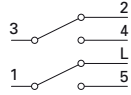

- 10 AX 250 V~, Iloji SQ63
  - në përputhje me EN 60669-1
  - kontakte për futje telash 1,5-2,5 mm<sup>2</sup>
- SWITCH DOUBLE 2WAY 10AX 250V~*
- 10AX 250V~, type SQ63
  - in accordance with EN 60669-1
  - plug-in contacts 1.5-2.5mm<sup>2</sup>



ÇELËS NDËRMJETËS 10 AX 250 V~



- SQ70PWXO
- SQ70TIXO
- SQ70ATXO
- SQ70ATXO

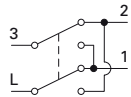

- 10 AX 250 V~, Iloji SQ70
  - në përputhje me EN 60669-1
  - kontakte për futje telash 1,5-2,5 mm<sup>2</sup>
- SWITCH INTERMEDIATE 10AX 250V~*
- 10AX 250V~, type SQ70
  - in accordance with EN 60669-1
  - plug-in contacts 1.5-2.5mm<sup>2</sup>



SQ10  
SQ11

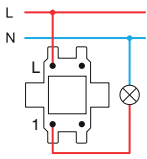

SQ22

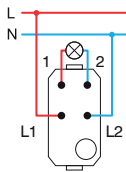

SQ50  
SQ51

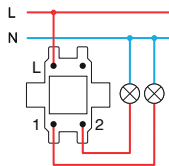

SQ52  
SQ53

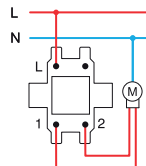

SQ60+SQ60

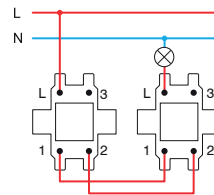

SQ63+SQ63

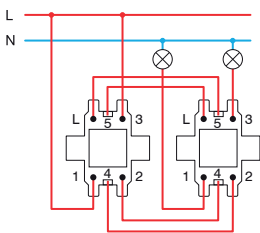

SQ60+SQ70+SQ60

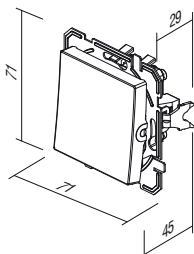
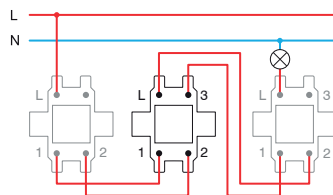

## S I G N A L I Z A T I O N I A

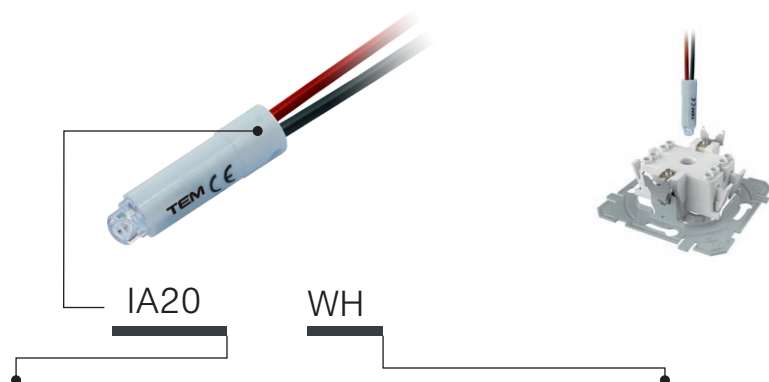

Iloji type	përshkrimi description	të dhënat teknike technical data	ngjyra colour
IA10	LLAMBË NEONI NEON LAMP	230V~ 0,34W	<input type="checkbox"/> WH e bardhë white
IA20	SINJALIZIMI LED LED SIGNALLING UNIT	230V~ 0,40W	<input checked="" type="checkbox"/> BL blu blue
IA21	SINJALIZIMI LED LED SIGNALLING UNIT	24V AC/DC 0,20W	<input checked="" type="checkbox"/> RD e kuqe red
.	.	.	<input checked="" type="checkbox"/> GR e gjelbër green
.	.	.	<input checked="" type="checkbox"/> OR portokalli orange

## LLAMBË NEONI 230 V~ 0,34 W

 IA10OR

- për indikim, sinjalizim ose sinjalizim të përhershëm
- në kombinim me një buton që ka një tregues

NEON LAMP 230V~ 0,34W

- for indication, signalling or permanent signalling
- in combination with a button featuring an indicator

## SINJALIZIMI LED 230 V AC/DC 0,40 W

 IA20WH  
 IA20GR  
 IA20RD  
 IA20BL

- për indikim, sinjalizim ose sinjalizim të përhershëm
- në kombinim me një buton që ka një tregues

LED SIGNALLING UNIT 230V AC/DC 0,40W

- for indication, signalling or permanent signalling
- in combination with a button featuring an indicator

## SINJALIZIMI LED 24 V AC/DC 0,20 W



 IA21WH  
 IA21RD

- për indikim, sinjalizim ose sinjalizim të përhershëm
- në kombinim me një buton që ka një tregues

LED SIGNALLING UNIT 24V AC/DC 0,20W

- for indication, signalling or permanent signalling
- in combination with a button featuring an indicator

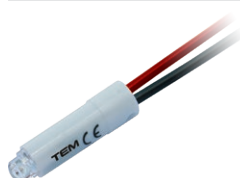
## SINJALIZIMI LED 12 V AC/DC 0,10 W

 IA22WH  
 IA22RD

- për indikim, sinjalizim ose sinjalizim të përhershëm
- në kombinim me një buton që ka një tregues

LED SIGNALLING UNIT 12V AC/DC 0,10W

- for indication, signalling or permanent signalling
- in combination with a button featuring an indicator

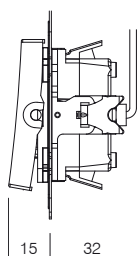

15

32



Tregues  
Indication

\*Sinjalizimi  
Signalization

Sinjalizimi i përhershëm  
Permanent signalling

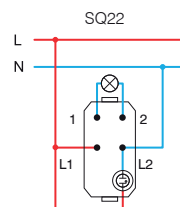
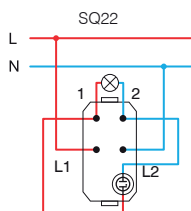
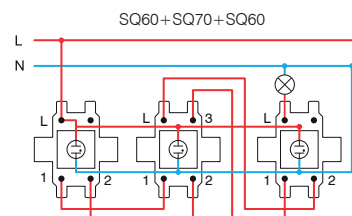
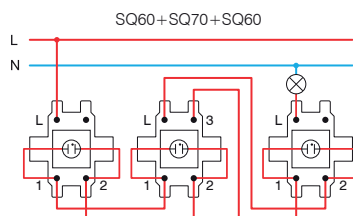
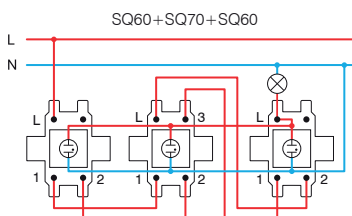
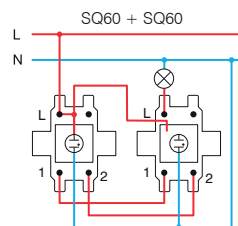
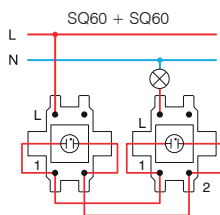
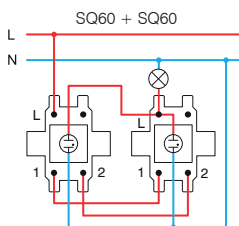
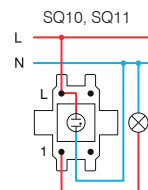
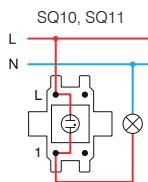
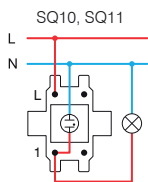

\* lidhjet janë të papërshtatshme për llamba që kursejnë energji (CFL, LED) /  
the connections are not suitable for energy-saving bulbs (CFL, LED)

## S O C K E T S V Q

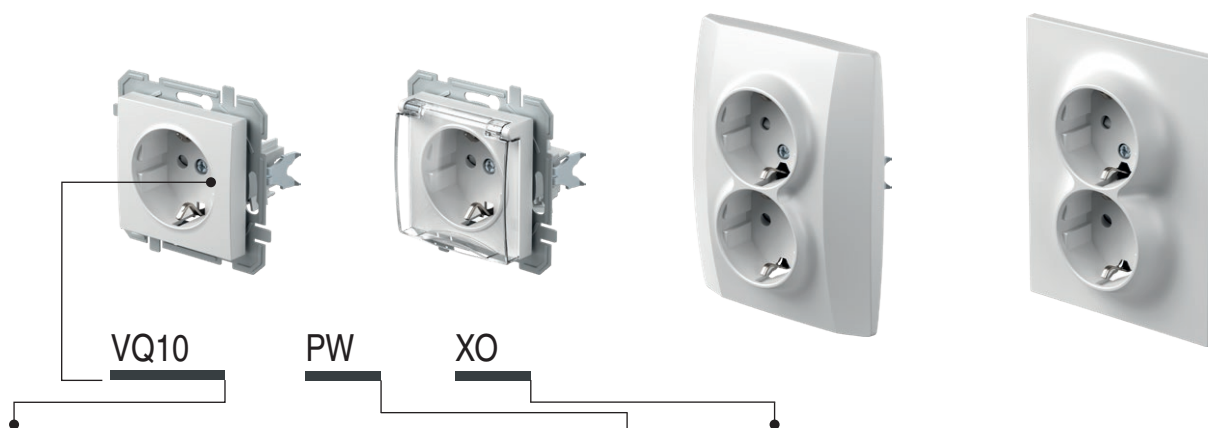

Iloji type	përshkrimi description	të dhënat teknike technical data	të dhënat opsionale 1 optional data 1
VQ10	PRIZË SCHUKO SOCKET SCHUKO	2P+E 16A 250V~	XO pa kapak mbulues without cover plate
VQ11	PRIZË SCHUKO+KAPAK SOCKET SCHUKO+COVER	2P+E 16A 250V~	
VQ12	PRIZË SCHUKO SOCKET SCHUKO	2P+E 16A 250V~ BV	
:	:	:	
:	:	:	

ngjyra  
colour

<input type="checkbox"/> PW e bardhë polare polar white	<input type="checkbox"/> PT e bardhë+transparente white+transparent	<input type="checkbox"/> PP e bardhë+e bardhë white+white
<input type="checkbox"/> TI titan titanium	<input type="checkbox"/> TT titan+transparente titanium+transparent	<input type="checkbox"/> TI titan+titan titanium+titanium
<input type="checkbox"/> AT antracit anthracite	<input type="checkbox"/> AT antracit+transparente anthracite+transparent	<input type="checkbox"/> AA antracit+antracit anthracite+anthracite
<input type="checkbox"/> BK e zezë black	<input type="checkbox"/> BT e zezë+transparente black+transparent	<input type="checkbox"/> BB e zezë+ e zezë black+black
<input type="checkbox"/> RD e kuqe red	<input type="checkbox"/> RT e kuqe+transparente red+transparent	<input type="checkbox"/> RR e kuqe+e kuqe red+red
<input type="checkbox"/> GR e gjelbër green	<input type="checkbox"/> GT e gjelbër+transparente green+transparent	<input type="checkbox"/> GG e gjelbër+e gjelbër green+green
<input type="checkbox"/> OR portokalli orange	<input type="checkbox"/> OT portokalli+transparente orange+transparent	<input type="checkbox"/> OO portokalli+portokalli orange+orange



schuko - në përputhje me EN 60884-1, CEE7 (fleta e standardit III)

schuko - in accordance with EN 60884-1, CEE7 (standard sheet III)

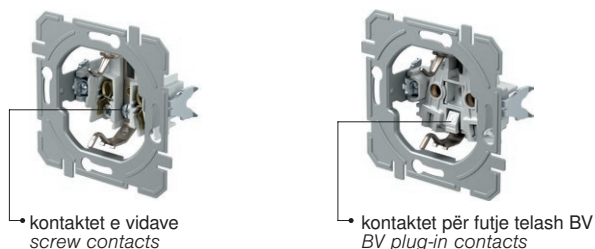

• kontaktet e vidave  
screw contacts

• kontaktet për futje telash BV  
BV plug-in contacts

PRIZË SCHUKO 2P+E 16 A 250 V~ \_\_ XO

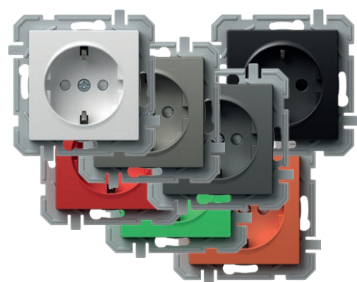

- VQ10PWXO
- VQ10TIXO
- VQ10ATXO
- VQ10ATXO
- VQ10RDXO
- VQ10GRXO
- VQ10ORXO

- kontaktet e vidave 1,5-2,5 mm<sup>2</sup>
- XO pa kapak mbulues
- schuko 2P+E
- 16 A 250 V~, lloji VQ10
- kontaktet me rrymën të mbuluara



SOCKET SCHUKO 2P+E 16A 250V~ \_\_ XO

- screw contacts 1.5-2.5mm<sup>2</sup>
- XO without surround
- 2P+E schuko
- 16A 250V~, type VQ10
- shuttered live contacts

PRIZË SCHUKO+KAPAK 2P+E 16 A 250 V~ \_\_ XO

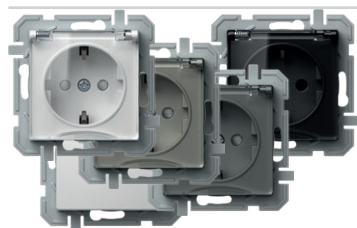

- VQ11PTXO
- VQ11TTXO
- VQ11ATXO
- VQ11BTXO
- VQ11PPXO

- kontaktet e vidave 1,5-2,5 mm<sup>2</sup>
- XO pa kapak mbulues
- schuko 2P+E schuko+kapak
- 16 A 250 V~, lloji VQ11
- kontaktet me rrymën të mbuluara



SOCKET SCHUKO+COVER 2P+E 16A 250V~ \_\_ XO

- screw contacts 1.5-2.5mm<sup>2</sup>
- XO without surround
- 2P+E schuko+cover
- 16A 250V~, type VQ11
- shuttered live contacts

PRIZË SCHUKO 2P+E 16 A 250 V~ BV \_\_ XO

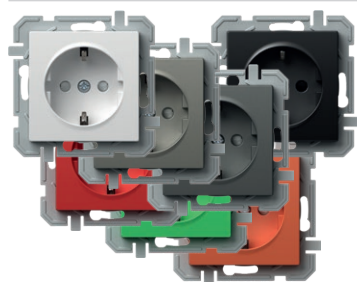

- VQ12PWXO
- VQ12TIXO
- VQ12ATXO
- VQ12BKXO
- VQ12RDXO
- VQ12GRXO
- VQ12ORXO

- BV kontakte për futje telash 1,5-2,5 mm<sup>2</sup>
- XO pa kapak mbulues
- schuko 2P+E
- 16 A 250 V~, lloji VQ12
- kontaktet me rrymën të mbuluara



SOCKET SCHUKO 2P+E 16A 250V~ BV \_\_ XO

- BV plug-in contacts 1.5-2.5mm<sup>2</sup>
- XO without surround
- 2P+E schuko
- 16A 250V~, type VQ12
- shuttered live contacts

PRIZË SCHUKO+KAPAK 2P+E 16 A 250 V~ BV \_\_ XO



- VQ13PTXO
- VQ13TTXO
- VQ13ATXO
- VQ13BTXO
- VQ13PPXO

- kontakte BV për futje telash 1,5-2,5 mm<sup>2</sup>
- XO pa kapak mbulues
- schuko 2P+E schuko+kapak
- 16 A 250 V~, lloji VQ13
- kontaktet me rrymën të mbuluara



SOCKET SCHUKO+COVER 2P+E 16A 250V~ BV \_\_ XO

- BV plug-in contacts 1.5-2.5mm<sup>2</sup>
- XO without surround
- 2P+E schuko+cover
- 16A 250V~, type VQ13
- shuttered live contacts

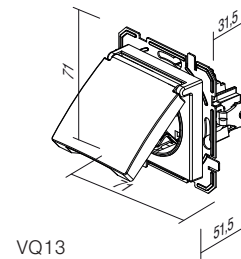
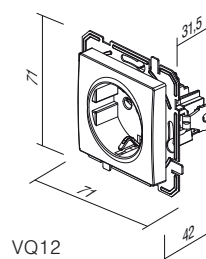
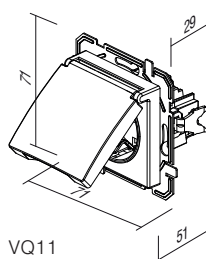
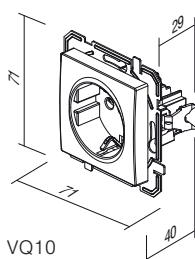

## S O C K E T S V Q

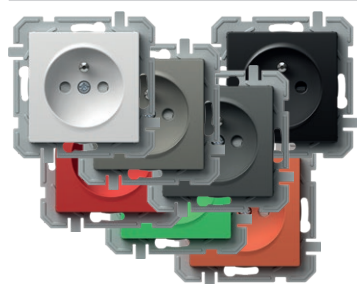

- VQ40PWXO
- VQ40TIXO
- VQ40ATXO
- VQ40BKXO

- VQ40RDXO
- VQ40GRXO
- VQ40ORXO

## PRIZË FRANCEZE 2P+E 16 A 250 V~ \_\_ XO

- kontaktet e vidave 1,5-2,5 mm<sup>2</sup>
- XO pa kapak mbulues
- 2P+E Franceze
- 16 A 250 V~, lloji VQ40
- kontaktet me rrymën të mbuluara

## SOCKET FRENCH 2P+E 16A 250V~ \_\_ XO

- screw contacts 1.5-2.5mm<sup>2</sup>
- XO without surround
- 2P+E French
- 16A 250V~, type VQ40
- shuttered live contacts



## PRIZË FRANCEZE+KAPAK 2P+E 16 A 250 V~ \_\_ XO



- VQ41PTXO
- VQ41TTXO
- VQ41ATXO
- VQ41BTXO

- VQ41PPXO

- kontaktet e vidave 1,5-2,5 mm<sup>2</sup>
- XO pa kapak mbulues
- 2P+E Franceze+kapak
- 16 A 250 V~, lloji VQ41
- kontaktet me rrymën të mbuluara

## SOCKET FRENCH+COVER 2P+E 16A 250V~ \_\_ XO

- screw contacts 1.5-2.5mm<sup>2</sup>
- XO without surround
- 2P+E French+cover
- 16A 250V~, type VQ41
- shuttered live contacts



## PRIZË SCHUKO DYSHE 2P+E 16 A 250 V~



- VQ16PW
- VQ16TI
- VQ16AT
- VQ16BK

- schuko dyshe 2P+E
- 16 A 250 V~, lloji VQ16
- në përputhje me IEC 60884-1, CEE7
- kontaktet e vidave 1,5-2,5 mm<sup>2</sup>
- kontaktet me rrymën të mbuluara

## SOCKET SCHUKO DOUBLE 2P+E 16A 250V~

- 2P+E schuko double
- 16A 250V~, type VQ16
- in accordance with IEC 60884-1, CEE7
- screw contacts 1.5-2.5 mm<sup>2</sup>
- shuttered live contacts



## PRIZË SCHUKO DYSHE 2P+E 16 A 250 V~



- VQ16PWF
- VQ16TIF
- VQ16ATF
- VQ16BKF

- schuko dyshe 2P+E
- 16 A 250 V~, lloji VQ16
- në përputhje me IEC 60884-1, CEE7
- kontaktet e vidave 1,5-2,5 mm<sup>2</sup>
- kontaktet me rrymën të mbuluara

## SOCKET SCHUKO DOUBLE 2P+E 16A 250V~

- 2P+E schuko double
- 16A 250V~, type VQ16
- in accordance with IEC 60884-1, CEE7
- screw contacts 1.5-2.5 mm<sup>2</sup>
- shuttered live contacts

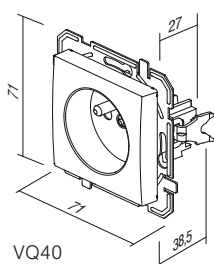

VQ40

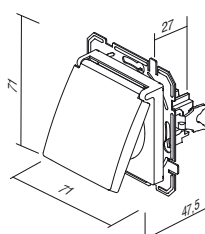

VQ41

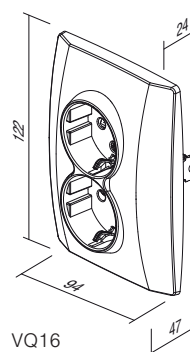

VQ16

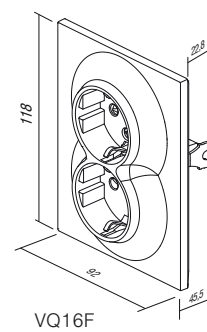

VQ16F





PRIZË FRANCEZE 2P+E 16 A 250 V~ BV \_\_ XO

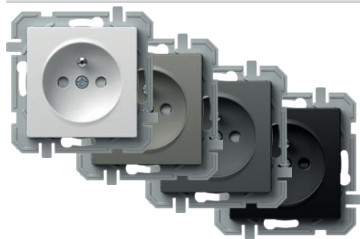

- VQ42PWXO
- VQ42TIXO
- VQ42ATXO
- VQ42BKXO

- BV kontakte për futje telash 1,5-2,5 mm<sup>2</sup>
- XO pa kapak mbulues
- 2P+E Franceze
- 16 A 250 V~, lloji VQ42
- kontaktet me rrymën të mbuluara



SOCKET FRENCH 2P+E 16A 250V~ BV \_\_ XO

- BV plug-in contacts 1.5-2.5mm<sup>2</sup>
- XO without surround
- 2P+E French
- 16A 250V~, type VQ42
- shuttered live contacts

PRIZË FRANCEZE+KAPAK 2P+E 16 A 250 V~ BV \_\_ XO



- VQ43PTXO
- VQ43TTXO
- VQ43ATXO
- VQ43BTXO
- VQ43PPXO

- BV kontakte për futje telash 1,5-2,5 mm<sup>2</sup>
- XO pa kapak mbulues
- 2P+E Franceze+kapak
- 16 A 250 V~, lloji VQ43
- kontaktet me rrymën të mbuluara



SOCKET FRENCH+COVER 2P+E 16A 250V~ BV \_\_ XO

- BV plug-in contacts 1.5-2.5mm<sup>2</sup>
- XO without surround
- 2P+E French+cover
- 16A 250V~, type VQ43
- shuttered live contacts

PRIZË FRANCEZE DYSHE 2P+E 16 A 250 V~



- VQ46PW
- VQ46TI
- VQ46AT
- VQ46BK

- 2P+E franceze dyshe
- 16 A 250 V~, lloji VQ46
- në përputhje me IEC 60884-1, CEE7; NF C 61-314, ČSN 33 2318; PN-E 93201
- kontaktet e vidave 1,5-2,5 mm<sup>2</sup>
- kontaktet me rrymën të mbuluara



SOCKET FRENCH DOUBLE 2P+E 16A 250V~

- 2P+E French double
- 16A 250V~, type VQ46
- in accordance with IEC 60884-1, CEE7; NF C 61-314, ČSN 33 2318; PN-E 93201
- screw contacts 1,5-2,5 mm<sup>2</sup>
- shuttered live contacts

PRIZË FRANCEZE DYSHE 2P+E 16 A 250 V~



- VQ46PWF
- VQ46TIF
- VQ46ATF
- VQ46BKF

- 2P+E franceze dyshe
- 16 A 250 V~, lloji VQ46
- në përputhje me IEC 60884-1, CEE7; NF C 61-314, ČSN 33 2318; PN-E 93201
- kontaktet e vidave 1,5-2,5 mm<sup>2</sup>
- kontaktet me rrymën të mbuluara



SOCKET FRENCH DOUBLE 2P+E 16A 250V~

- 2P+E French double
- 16A 250V~, type VQ46
- in accordance with IEC 60884-1, CEE7; NF C 61-314, ČSN 33 2318; PN-E 93201
- screw contacts 1,5-2,5 mm<sup>2</sup>
- shuttered live contacts

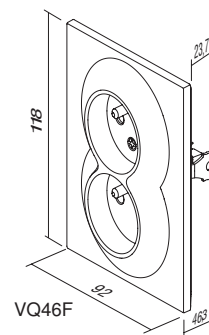
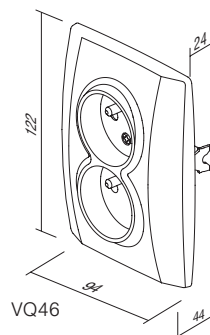
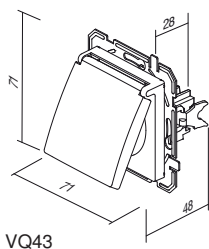
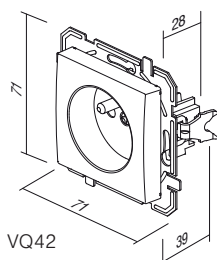

## C O M M U N I C A T I O N S K Q



KQ37

PW

XO

Iloji type	përshkrimi description	të dhënat teknike technical data	ngjyra colour	të dhënat opsionale 1 optional data 1
KQ11	PRIZË TV-R ME KAPAK FUNDOR SOCKET TV-R END-LINE	1dB	<input type="checkbox"/> PW e bardhë polare polar white	XO pa kapak mbulues without cover plate
KQ12	PRIZË TV-R KALUESE SOCKET TV-R THROUGHPASS	10dB	<input type="checkbox"/> TI titan titanium	
KQ16	PRIZË SAT-TV-R ME KAPAK FUNDOR SOCKET SAT-TV-R END-LINE	3dB	<input type="checkbox"/> AT antracit anthracite	
...		...	<input type="checkbox"/> BK e zezë black	

## PRIZË TV BAZË 0 dB



- KQ10PWXXO
- KQ10TIXO
- KQ10ATXO
- KQ10BKXO

- TV bazë
- reduktim 0 dB
- konektor i pasmë – F standard

## SOCKET TV BASIC 0dB

- TV basic
- reduction 0dB
- back connector – F standard



## PRIZË TV-R ME KAPAK FUNDOR 1 dB

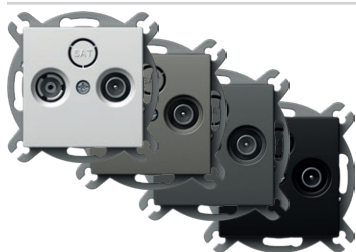

- KQ11PWXXO
- KQ11TIXO
- KQ11ATXO
- KQ11BKXO

- TV-R me kapak fundor
- gama e frekuencës 5÷862 MHz
- reduktimi: R-1,5 dB, TV-1 dB
- në përputhje me EN 50083-1
- kontakti i vidave

## SOCKET TV-R END-LINE 1dB

- TV-R end-line
- frequency range 5÷862 MHz
- reduction: R-1.5dB, TV-1dB
- in accordance with EN 50083-1
- screw contact



PRIZË TV-R KALUESE 10 dB

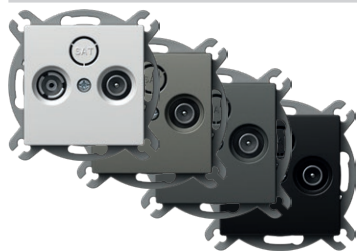

- KQ12PWXO
- KQ12TIXO
- KQ12ATXO
- KQ12BKXO

- TV-R kaluese
- gama e frekuencës 5÷862 MHz
- reduktimi: R-10 dB, TV-10 dB, kaluese-2 dB
- në përputhje me EN 50083-1
- kontaktet e vidave



SOCKET TV-R TROUGH-PASS 10dB

- TV-R troughpass
- frequency range 5÷862 MHz
- reduction: R-10dB, TV-10dB, trough-2dB
- in accordance with EN 50083-1
- screw contacts

PRIZË SAT-TV-R ME KAPAK FUNDOR 3 dB

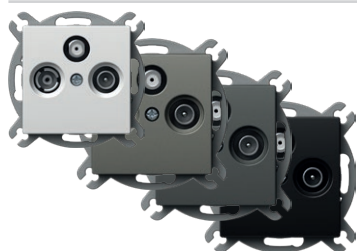

- KQ16PWXO
- KQ16TIXO
- KQ16ATXO
- KQ16BKXO

- SAT-TV-R me kapak fundor
- gama e frekuencës 5÷2400 MHz
- reduktimi: R-1 dB, TV-1,5 dB, SAT-3 dB
- në përputhje me EN 50083-1
- kontaktet e vidave



SOCKET SAT-TV-R END-LINE 3dB

- SAT-TV-R end-line
- frequency range 5÷2400 MHz
- reduction: R-1dB, TV-1,5dB, SAT-3dB
- in accordance with EN 50083-1
- screw contacts

PRIZË AUDIO 2xRCA



- KQ22PWXO
- KQ22TIXO
- KQ22ATXO
- KQ22BKXO

- audio 2xRCA
- lidhje me saldime e kablllos

SOCKET AUDIO 2xRCA

- audio 2xRCA
- soldering connection of cable



PRIZË AUDIO PËR ALTOPARLANTË



- KQ23PWXO
- KQ23TIXO
- KQ23ATXO
- KQ23BKXO

- audio 2x Ø4 mm
- për të mbajtur telin e altoparlantit, spinë banane Ø4mm ose pirun
- lidhje me ngjitje e kablllos në pjesën e pasme

SOCKET AUDIO LOUDSPEAKERS

- audio 2x Ø4mm
- to accommodate speaker wire, banana plug Ø4mm or spades
- soldering connection of cable at the back side



PRIZË TEL KS RJ11 6/4



- KQ36PWXO
- KQ36TIXO
- KQ36ATXO
- KQ36BKXO

- standard fiksues trapez KS
- RJ11 6/4
- në përputhje me IEC 60603-7

SOCKET TEL KS RJ11 6/4

- KS keystone fixing standard
- RJ11 6/4
- in accordance with IEC 60603-7



## PRIZË CAT5e KS RJ45 8/8

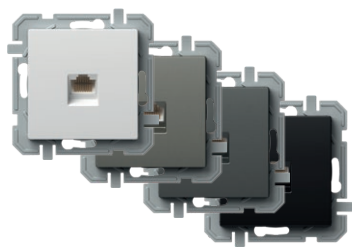

- KQ37PWXO
- KQ37TIXO
- KQ37ATXO
- KQ37BKXO

- standard fiksues trapez KS
- CAT5e, RJ45 8/8
- në përputhje me IEC 60603-7

*SOCKET CAT5e KS RJ45 8/8*  
 - KS keystone fixing standard  
 - CAT5e, RJ45 8/8  
 - in accordance with IEC 60603-7



## PRIZË TEL KS DYSHE 2x RJ11 6/4

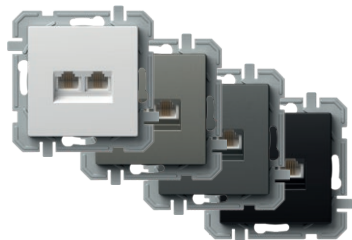

- KQ38PWXO
- KQ38TIXO
- KQ38ATXO
- KQ38BKXO

- standard fiksues trapez KS
- 2x RJ11, 6/4
- në përputhje me IEC 60603-7

*SOCKET TEL KS DOUBLE 2x RJ11 6/4*  
 - KS keystone fixing standard  
 - 2x RJ11, 6/4  
 - in accordance with IEC 60603-7



## PRIZË CAT5e KS DYSHE 2x RJ45 8/8



- KQ39PWXO
- KQ39TIXO
- KQ39ATXO
- KQ39BKXO

- standard fiksues trapez KS
- 2x CAT5e, RJ45 8/8
- në përputhje me IEC 60603-7

*SOCKET CAT5e KS DOUBLE 2x RJ45 8/8*  
 - KS keystone fixing standard  
 - 2x CAT5e, RJ45 8/8  
 - in accordance with IEC 60603-7



## PRIZË TEL LT RJ11 6/4



- KQ35PWXO
- KQ35TIXO
- KQ35ATXO
- KQ35BKXO

- vidë TEL LT
- kontaktet e vidave
- RJ11 6/4
- në përputhje me IEC 60603-7

*SOCKET TEL LT RJ11 6/4*  
 - TEL LT screw  
 - screw contacts  
 - RJ11 6/4  
 - in accordance with IEC 60603-7



## PRIZË CAT6s KS RJ45 8/8 E HOLLË



- KQ40PWXO
- KQ40TIXO
- KQ40ATXO
- KQ40BKXO

- standard fiksues trapez KS
- CAT6s, RJ45 8/8
- në përputhje me IEC 60603-7

*SOCKET CAT6s KS RJ45 8/8 SLIM*  
 - KS keystone fixing standard  
 - CAT6s, RJ45 8/8  
 - in accordance with IEC 60603-7



## PRIZË CAT6s KS DYSHE 2x RJ45 8/8 E HOLLË



- KQ41PWXO
- KQ41TIXO
- KQ41ATXO
- KQ41BKXO

- standard fiksues trapez KS
- 2x CAT6s, RJ45 8/8
- në përputhje me IEC 60603-7

*SOCKET CAT6s KS DOUBLE 2x RJ45 8/8 SLIM*  
 - KS keystone fixing standard  
 - 2x CAT6s, RJ45 8/8  
 - in accordance with IEC 60603-7

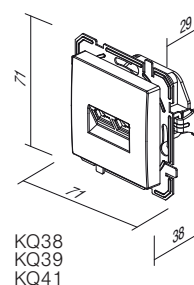
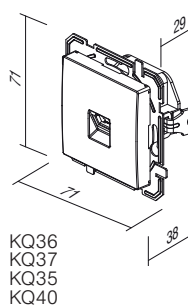
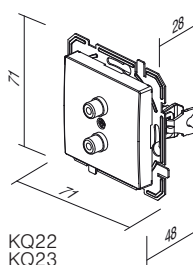
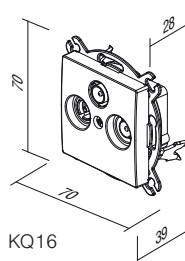
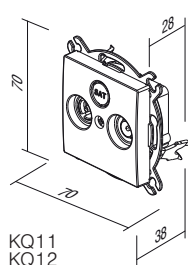
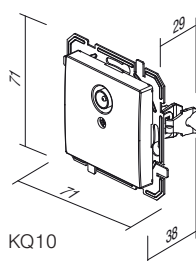





EQ15

PW

XO

Iloji type	përshkrimi description	të dhënat teknike technical data	ngjyra colour	të dhënat opsionale 1 optional data 1
EQ15	REOSTAT RROTULLUES ME 2 DREJTIME DIMMER ROTATIVE 2WAY	RL 400W	<input type="checkbox"/> PW e bardhë polare polar white	XO pa kapak mbulues without cover plate
EQ16	REOSTAT RROTULLUES ME 2 DREJTIME DIMMER ROTATIVE 2WAY	RLC 400W	<input type="checkbox"/> TI titan titanium	
EQ19	REOSTAT RROTULLUES ME 2 DREJTIME DIMMER ROTATIVE 2WAY	LED 100W	<input type="checkbox"/> AT antracit anthracite	
...	...	...	<input type="checkbox"/> BK e zezë black	

#### REOSTAT RROTULLUES ME 2 DREJTIME RL 400 W

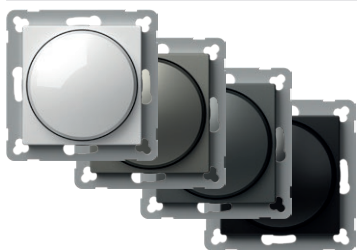

- EQ15PWXO
- EQ15TIXO
- EQ15ATXO
- EQ15BKXO



- kontrolli i rrotullimit me çelës me 2 drejtime
- RL i ngarkesës, 40 W - 400W
- është i mundur kombinimi i çelësit me 2 drejtime
- nuk lejohet kombinim i më shumë reostateve
- në përputhje me standardet EN 60669-1 dhe EN 60669-2-1
- kontakte për futje telash 1,5 mm<sup>2</sup>
- furnizimi, 230 V ~ 50 Hz
- përfshihet siguresa e zëvendësueshme



#### DIMMER ROTATIVE 2WAY RL 400W

- rotation control with 2-way switch
- load RL, 40W - 400W
- 2-way switch combination is possible
- more dimmers combination is not allowed
- in accordance with EN 60669-1 and EN 60669-2-1
- plug-in contacts 1.5mm<sup>2</sup>
- supply 230V~ 50Hz
- replaceable fuse included

#### REOSTAT RROTULLUES ME 2 DREJTIME RLC 400 W

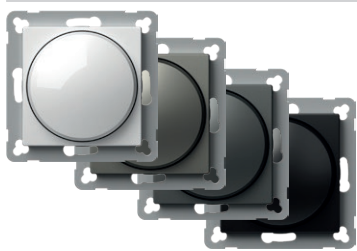

- EQ16PWXO
- EQ16TIXO
- EQ16ATXO
- EQ16BKXO



- kontrolli i rrotullimit me çelës me 2 drejtime
- RLC i ngarkesës, 20W - 400W
- është i mundur kombinimi i çelësit me 2 drejtime
- nuk lejohet kombinim i më shumë reostateve
- në përputhje me standardet EN 60669-1 dhe EN 60669-2-1
- kontakte për futje telash 1,5 mm<sup>2</sup>
- furnizimi, 230 V ~ 50 Hz
- siguresë elektronike



#### DIMMER ROTATIVE 2WAY RLC 400W

- rotation control with 2-way switch
- load RLC, 20W - 400W
- 2-way switch combination is possible
- more dimmers combination is not allowed
- in accordance with EN 60669-1 and EN 60669-2-1
- plug-in contacts 1.5mm<sup>2</sup>
- supply 230V~ 50Hz
- electronic fuse

#### REOSTAT RROTULLUES ME 2 DREJTIME LED 100 W

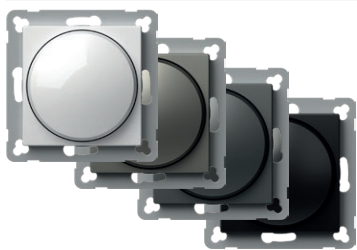

- EQ19PWXO
- EQ19TIXO
- EQ19ATXO
- EQ19BKXO



- kontrolli i rrotullimit me çelës me 2 drejtime
- ngarkesa: LED, 0-100 W (maks. 10 LED-e)  
GLS, 10-250 W
- është i mundur kombinimi i çelësit me 2 drejtime
- nuk lejohet kombinim i më shumë reostateve
- në përputhje me standardet EN 60669-1 dhe EN 60669-2-1
- kontakte për futje telash 1,5 mm<sup>2</sup>
- furnizimi, 230 V ~ 50 Hz
- përfshihet siguresa e zëvendësueshme



#### DIMMER ROTATIVE 2WAY LED 100W

- rotation control with 2-way switch
- load: LED, 0-100W (max. 10 LEDs)  
GLS, 10-250W
- 2-way switch combination is possible
- more dimmers combination is not allowed
- in accordance with EN 60669-1 and EN 60669-2-1
- plug-in contacts 1.5mm<sup>2</sup>
- supply 230V~ 50Hz
- replaceable fuse included

EQ15, EQ16, EQ19

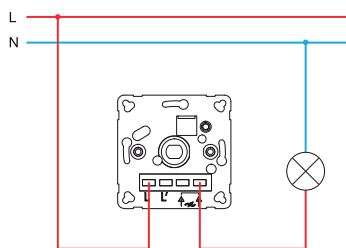

EQ15, EQ16, EQ19

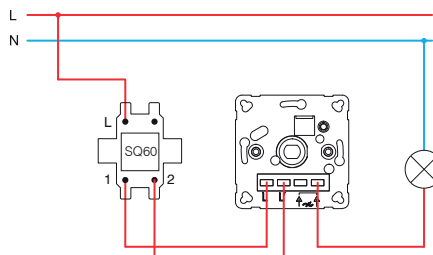

EQ15, EQ16, EQ19

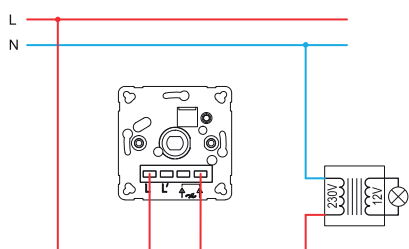

EQ15, EQ16, EQ19

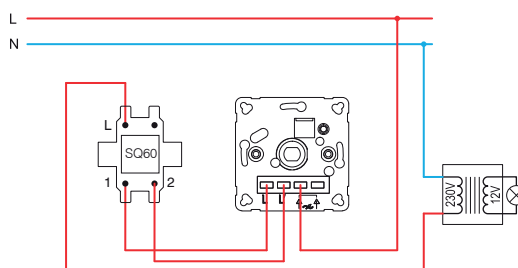

EQ16, EQ19

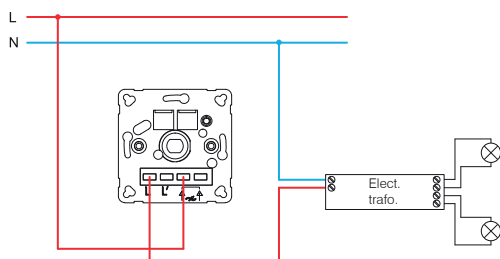

EQ16, EQ19

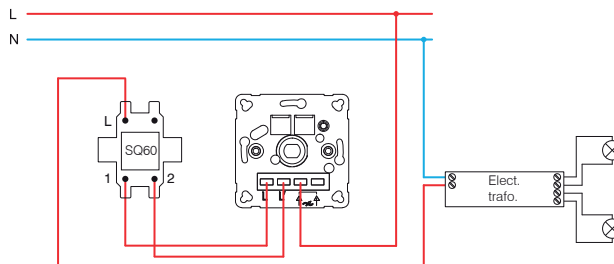
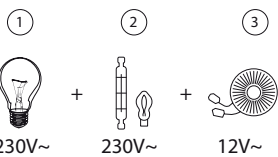
**EQ15 (40÷400W)**

- 1 - llambë inkandeshente  
*incandescent lamp*
- 2 - llambë halogjene  
*halogen lamp*

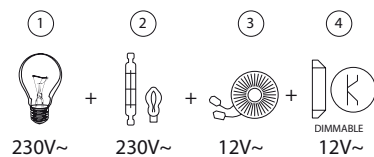
**EQ16 (20÷400W)**

- 3 - transformator klasik  
*classical transformer*
- 4 - transformator elektrik me ule ndriçimi  
*dimmable electronic transformer*

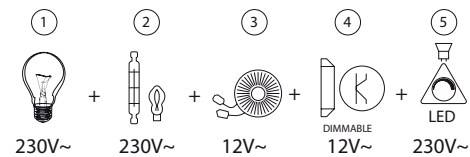
**EQ19 (GLS 10÷250W ; LED 0÷100W)**

- 5 - llambë LED me ulje ndriçimi  
*dimmable LED lamp*

### ÇELËS IR 5A X 230 V~



- EQ32PWXO
- EQ32TIXO
- EQ32ATXO
- EQ32BKXO

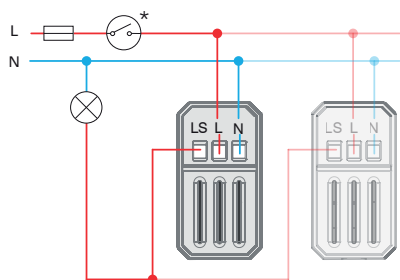

#### IR SWITCH 5A 230V~

- IR infrared switch
- supply voltage: 230V~ ±10% 50Hz
- relay: 5A / 250V~ output for limited current with high resistance for zero crossing
- protection rating: IP40
- cross-section of wires at the contact terminal: 0.75 - 2.5 mm<sup>2</sup>
- detection angle: up to 110° at 20°C
- detection area: approx. 8 m at 20°C
- adjustability of duration: from approx. 5 s to 12 min
- adjustability of brightness: from approx. 5 to 200 LUX
- operating temperature: from 0°C to +40°C
- not suitable for installation in 45 mm deep boxes
- only for indoor usage

### TERMOSTAT PËR NGROHJE 10 A 230 V~

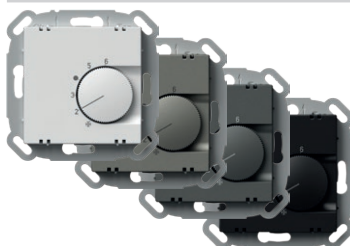

- EQ35PWXO
- EQ35TIXO
- EQ35ATXO
- EQ35BKXO

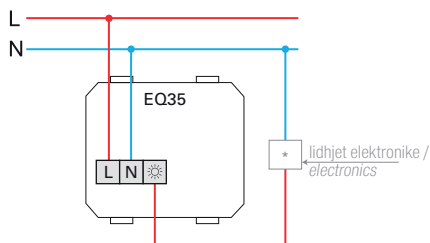

#### THERMOSTAT HEATING 10A 230V~

- operation mode: heating
- power supply: 230 V~, 50 Hz
- output: 4 A (max. 10 A), 230 V~, 50 Hz
- switching contact: NC (max. 10 actuators)
- regulation range: +5 °C to +30 °C
- hysteresis: 0,5 K
- protection: IP30
- sensor type: bimetal
- type of electrical connection: spring-loaded contacts
- type of conductors: 0,75 - 1,5mm<sup>2</sup> (flexible-stranded core) or 1,0 - 2,5 mm<sup>2</sup> (solid core)

### TERMOSTAT PËR NGROHJE/FTOHJE 5 A 230 V~

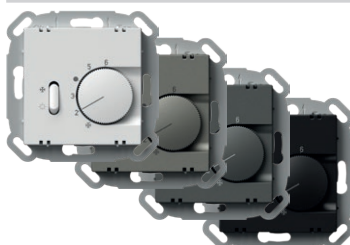

- EQ36PWXO
- EQ36TIXO
- EQ36ATXO
- EQ36BKXO

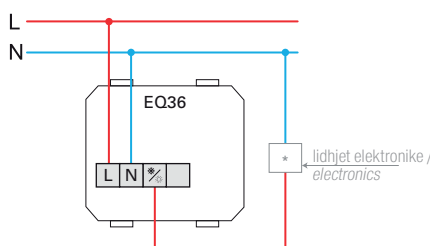

#### THERMOSTAT HEATING / COOLING 5A 230V~

- operation mode: heating / cooling
- power supply: 230 V~, 50 Hz
- output: 2 A (max. 5 A), 230 V~, 50 Hz
- switching contact: changeover switch (toggler, max. 5 actuators)
- regulation range: +5 °C to +30 °C
- hysteresis: 0,5 K
- protection: IP30
- sensor type: bimetal
- type of electrical connection: spring-loaded contacts
- type of conductors: 0,75 - 1,5mm<sup>2</sup> (flexible-stranded core) or 1,0 - 2,5 mm<sup>2</sup> (solid core)

## NGROHJE ME TERMOSTAT NGA DYSHEMEJA 16 A 230 V~

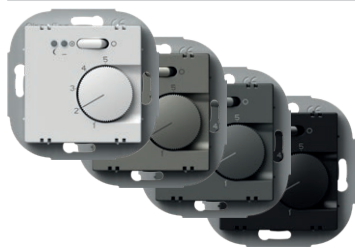

- EQ37PWXO
- EQ37TIXO
- EQ37ATXO
- EQ37BKXO

- modaliteti i funksionimit: ngrohje nga dysHEMEJA
- furnizimi me energji: 230 V~, 50 Hz
- dalja: 2 A (maks. 16 A), 230 V~, 50 Hz
- gama e rregullimit: +10 °C deri në +50 °C
- histereza: 1 K
- mbrojtja: IP30
- lloji i sensorit: NTC në përputhje me DIN EN 60730-2-1
- treguesit: LED i kuq për ngrohje dhe LED i gjelbër për modalitetin e uljes së dritës gjatë natës
- lloji i lidhjes elektrike: Kontaktet e vidave
- lloji i përcuesve: 0,5 – 2,5 mm<sup>2</sup>

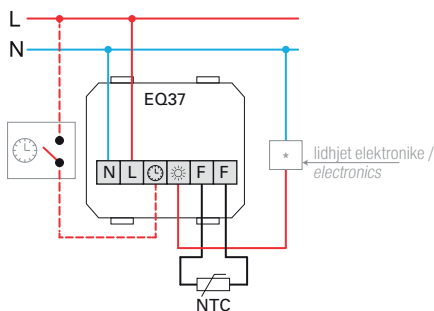

## THERMOSTAT FLOOR HEATING 16A 230V~

- operation mode: floor heating
- power supply: 230 V~, 50 Hz
- output: 2 A (max. 16 A), 230 V~, 50 Hz
- regulation range: +10 °C to +50 °C
- hysteresis: 1 K
- protection: IP30
- sensor type: NTC in compliance with DIN EN 60730-2-1
- indicators: Red LED for heating and green LED for night decrease mode
- type of electrical connection: Screw contacts
- type of conductors: 0,5 – 2,5mm<sup>2</sup>



- EQ68PWXO
- EQ68TIXO
- EQ68ATXO
- EQ68BKXO

## NJËSI USB E FURNIZIMIT ME ENERGJI 5 V 3,0 A

- Furnizimi 100 – 230 V ~ 50/60 Hz
- Konsumi: 300 mA në 100V~ / 150 mA në 230 V~
- Konsumi në gjendje gatishmërie: 30 mW në 230 V~
- Tensioni nominal dalës: 5 ~ (±5%) SELV
- Valëzimi (ripple) i tensionit dalës: 150 mV
- Fuqia nominale dalëse:
  - EM68 , EQ68, EE68: 3,0 A (±10 %) ; (lloji USB A / USB C)
- Efikasiteti: maks. 77%
- Temperatura e punës: 0 °C/+45 °C (përdorimi i brendshëm)
- Kategoria e mbrojtjes IP: IP20, vetëm për përdorim të brendshëm
- Kategoria e sigurisë së pajisjes II
- Kategoria e mbitensionit (EN 62109): kategoria III
- Fiksimi me vidë i përcjellësit me diametër 2,5 mm<sup>2</sup>
- Pajisje me distancë kontakti prej së paku 3 mm



## USB POWER SUPPLY UNIT 5V 3.0A

- power supply: 100-230V~ 50/60Hz
- power consumption: 300mA at 100V~/150mA at 230V~
- standby power consumption: 30mW at 230V~
- nominal output voltage: 5 = (±5%) SELV
- output ripple voltage: 150mV
- nominal output current:
  - EM68 , EQ68, EE68: 3,0 A (±10 %) ; (Type USB A / USB C)
- efficiency: maximum of 77%
- operating temperature: 0 °C/+45 °C (indoor use)
- IP protection class: IP20, indoor use only
- class device II
- overvoltage category (IEC 60364-4-44) CAT II  
a low-voltage SPD (surge protective devices) in accordance with the EN 61643-11 intended to reduce the overvoltage category III to II must be installed upstream of the USB device
- screw contacts: max. 2.5 mm<sup>2</sup>
- device with a contact gap of at least 3mm

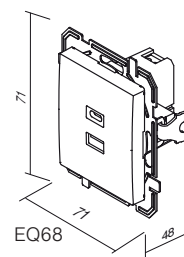
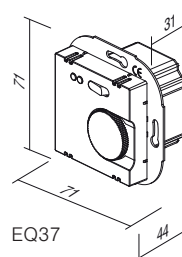
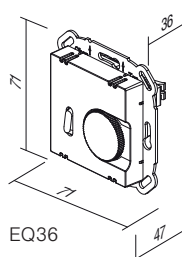
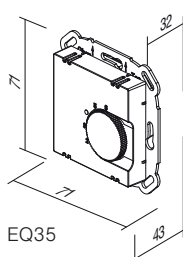
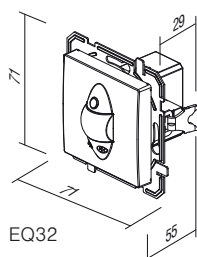
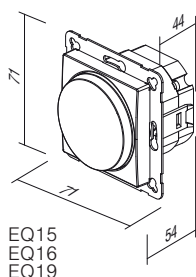
EQ15  
EQ16  
EQ19

EQ32

EQ35

EQ36

EQ37

EQ68



NEW



□ EQ01PWXO

RADIO ME MONTIM RRAFSH + ALTOPARLANT DAB BLUETOOTH

- furnizimi me energji: 230 V~ / 50 Hz
- konsumi i energjisë gjatë funksionimit normal: maks. 6 W
- konsumi i energjisë në gatishmëri: < 0,5 W
- klasi i mbrojtjes: IP20
- frekuencat e marrjes: DAB/DAB+ 174.928 - 239.200 MHz FM: 87.5 - 108 MHz
- bluetooth: Versioni V4.1, 2.402-2.480 GHz Klasi 2, maks. +4 dBm
- dalja e muzikës: 2 x 2W RMS
- hyrja e shtesës: Për çelësin e jashtëm (ndez radion / gatishmërinë)
- kushtet e ambientit
- lagështia relative: Përdorimi: 10 % - 75 % pa kondensim
- magazinimi: 5 % - 90 %
- temperatura: Përdorimi: 5 °C - 35 °C
- magazinimi: -20 °C - 60 °C



FLUSH MOUNTED RADIO + SPEAKER DAB BLUETOOTH

- power supply: 230 V~ / 50 Hz
- power consumption during normal operation: max. 6 W
- power consumption when on standby: < 0.5 W
- protection class: IP20
- reception frequencies: DAB/DAB+ 174.928 - 239.200 MHz FM: 87.5 - 108 MHz
- bluetooth: Version V4.1, 2.402-2.480 GHz Class 2, max. +4 dBm
- music output: 2 x 2W RMS
- extension input: For external switch (Switches radio on/ standby)
- ambient conditions
- relative humidity: Operation: 10 % - 75 % non-condensing
- storage: 5 % - 90 %
- temperature: Operation: 5 °C - 35 °C
- storage: -20 °C - 60 °C

NEW

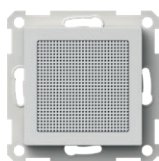

□ EQ02PWXO

ALTOPARLANT ME MONTIM RRAFSH

- klasi i mbrojtjes: IP20
- fuqia e muzikës: 2W RMS
- kushtet e ambientit
- lagështia relative: Përdorimi: 10 % - 75 % pa kondensim
- magazinimi: 5 % - 90 %
- temperatura: Përdorimi: 5 °C - 35 °C
- magazinimi: -20 °C - 60 °C



FLUSH MOUNTED SPEAKER

- protection class: IP20
- music power: 2W RMS
- ambient conditions
- relative humidity: Operation: 10 % - 75 % non-condensing
- storage: 5 % - 90 %
- temperature: Operation: 5 °C - 35 °C
- storage: -20 °C - 60 °C

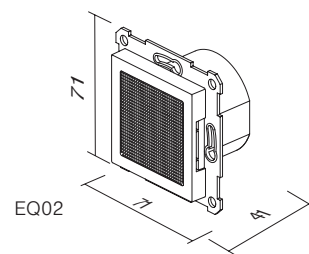
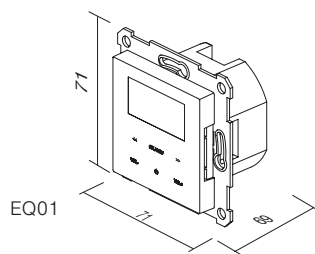

A K S E S O R Ë T P Q  
A C C E S S O R I E S P Q

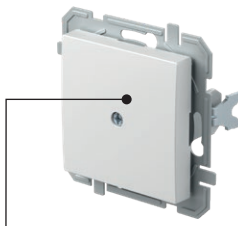

PQ10 PW XO

Iloji type	përshkrimi description	ngjyra colour	të dhënat opsionale 1 optional data 1
PQ10	TAPË BLANK	□ PW e bardhë polare polar white	XO pa kapak mbulues without cover plate
PQ30	KAPAK TAE/TDO COVER TAE/TDO	■ TI titan titanium ■ AT antracit anthracite ■ BK e zezë black	

## TAPË



- PQ10PWXO - për mbushjen e hapësirave boshe
  - PQ10TIXO
  - PQ10ATXO
  - PQ10BKXO
- BLANK  
- for filling up empty spaces



## KAPAK TAE/TDO

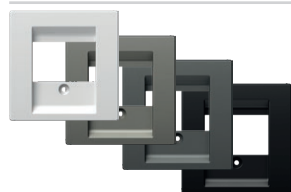

- PQ30PW
  - PQ30TI
  - PQ30AT
  - PQ30BK
- kapak TAE ose TDO me vidë  
COVER TAE/TDO  
- TAE or TDO cover with screw

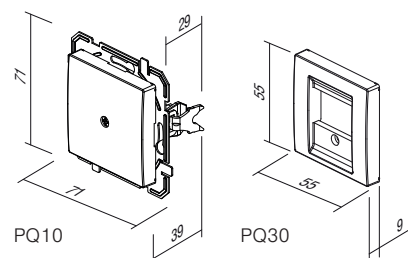

# K A P A K Ë T M B U L U E S B O L D O Q



OQ10

PW

Iloji type	përshkrimi description	ngjyra colour
OQ10	KAPAK MBULUES BOLD 1 COVER PLATE BOLD 1	PW e bardhë polare polar white
OQ20	KAPAK MBULUES BOLD 2 COVER PLATE BOLD 2	TI titan titanium
OQ30	KAPAK MBULUES BOLD 3 COVER PLATE BOLD 3	AT antracit anthracite
:	:	BK e zezë black



	OQ10PW
	OQ10TI
	OQ10AT
	OQ10BK

## KAPAK MBULUES BOLD 1

- kapakë mbulues dekorativë me 1 vend  
- në përputhje me EN 60669-1

*COVER PLATE BOLD 1*  
- decorative cover plate 1-gang  
- in accordance with EN 60669-1

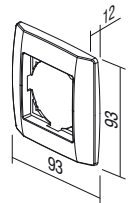

	OQ20PW
	OQ20TI
	OQ20AT
	OQ20BK

## KAPAK MBULUES BOLD 2

- kapak mbulues dekorativ me 2 vende  
- në përputhje me EN 60669-1

*COVER PLATE BOLD 2*  
- decorative cover plate 2-gang  
- in accordance with EN 60669-1

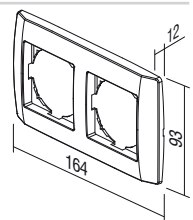

## C O V E R P L A T E S B O L D O Q

## KAPAK MBULUES BOLD 3



	QQ30PW
	QQ30TI
	QQ30AT
	QQ30BK

- kapak mbulues dekorativ me 3 vende
- në përputhje me EN 60669-1

*COVER PLATE BOLD 3*  
- decorative cover plate 3-gang  
- in accordance with EN 60669-1

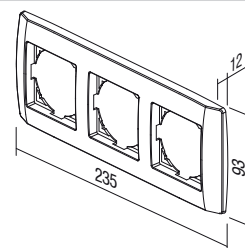

## KAPAK MBULUES BOLD 4



	QQ40PW
	QQ40TI
	QQ40AT
	QQ40BK

- kapak mbulues dekorativ me 4 vende
- në përputhje me EN 60669-1

*COVER PLATE BOLD 4*  
- decorative cover plate 4-gang  
- in accordance with EN 60669-1

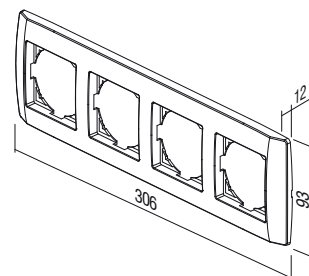

## KAPAK MBULUES BOLD 5



	QQ50PW
	QQ50TI
	QQ50AT
	QQ50BK

- kapak mbulues dekorativ me 5 vende
- në përputhje me EN 60669-1

*COVER PLATE BOLD 5*  
- decorative cover plate 5-gang  
- in accordance with EN 60669-1

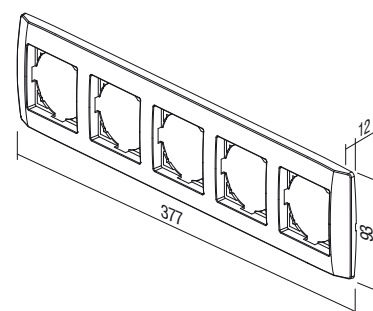





# KAPAKËT MBULUES FLAT OF

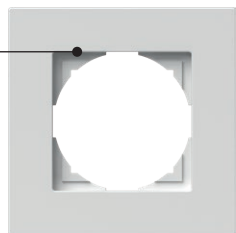

OF10

PW

Iloji type	përshkrimi description	ngjyra colour
OF10	KAPAK MBULUES FLAT 1 COVER PLATE FLAT 1	PW e bardhë polare polar white
OF20	KAPAK MBULUES FLAT 2 COVER PLATE FLAT 2	TI titan titanium
OF30	KAPAK MBULUES FLAT 3 COVER PLATE FLAT 3	AT antracit anthracite
:	:	BK e zezë black

## KAPAK MBULUES FLAT 1



- OF10PW
- OF10TI
- OF10AT
- OF10BK

- kapakë mbulues dekorativë me 1 vend  
- në përputhje me EN 60669-1

**COVER PLATE FLAT 1**  
- decorative cover plate 1-gang  
- in accordance with EN 60669-1

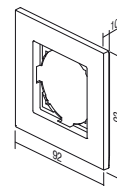

## KAPAK MBULUES FLAT 2



- OF20PW
- OF20TI
- OF20AT
- OF20BK

- kapak mbulues dekorativ me 2 vende  
- në përputhje me EN 60669-1



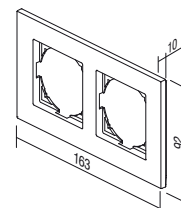

**COVER PLATE FLAT 2**  
- decorative cover plate 2-gang  
- in accordance with EN 60669-1



## C O V E R P L A T E S F L A T O F

## KAPAK MBULUES FLAT 3



	OF30PW
	OF30TI
	OF30AT
	OF30BK



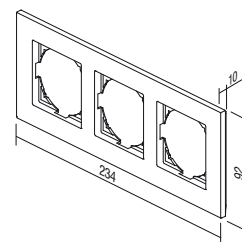

- kapak mbulues dekorativ me 3 vende
- në përputhje me EN 60669-1

*COVER PLATE FLAT 3*  
- decorative cover plate 3-gang  
- in accordance with EN 60669-1



## KAPAK MBULUES FLAT 4



	OF40PW
	OF40TI
	OF40AT
	OF40BK



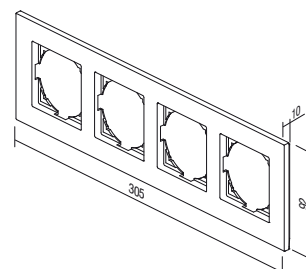

- kapak mbulues dekorativ me 4 vende
- në përputhje me EN 60669-1

*COVER PLATE FLAT 4*  
- decorative cover plate 4-gang  
- in accordance with EN 60669-1



## KAPAK MBULUES FLAT 5



	OF50PW
	OF50TI
	OF50AT
	OF50BK

- kapak mbulues dekorativ me 5 vende
- në përputhje me EN 60669-1

*COVER PLATE FLAT 5*  
- decorative cover plate 5-gang  
- in accordance with EN 60669-1

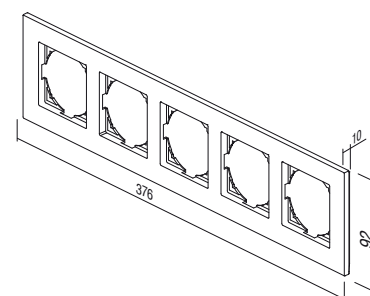



# K A P A K Ë T M B U L U E S P R I M E O R

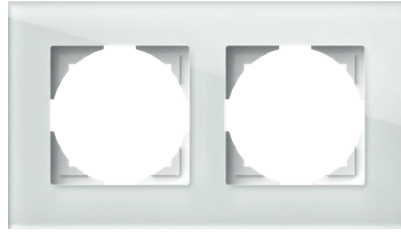

OR10

PW

Iloji type	përshkrimi description	ngjyra colour
OR10	KAPAK MBULUES PRIME 1 COVER PLATE PRIME 1	GL e bardhë glass light
OR20	KAPAK MBULUES PRIME 2 COVER PLATE PRIME 2	GD e zezë glass dark
OR30	KAPAK MBULUES PRIME 3 COVER PLATE PRIME 3	
⋮	⋮	
⋮	⋮	

## KAPAK MBULUES PRIME 1



OR10GL  
 OR10GD

- kapakë mbulues dekorativë me 1 vend
- në përputhje me EN 60669-1

*COVER PLATE PRIME 1*  
- decorative cover plate 1-gang  
- in accordance with EN 60669-1

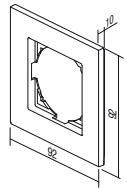

## KAPAK MBULUES PRIME 2



OR20GL  
 OR20GD

- kapak mbulues dekorativ me 2 vende
- në përputhje me EN 60669-1

*COVER PLATE PRIME 2*  
- decorative cover plate 2-gang  
- in accordance with EN 60669-1

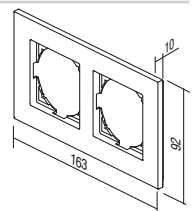

## C O V E R   P L A T E S   P R I M E   O R

## KAPAK MBULUES PRIME 3



OR30GL  
 OR30GD

- kapak mbulues dekorativ me 3 vende  
- në përputhje me EN 60669-1

*COVER PLATE PRIME 3*

- decorative cover plate 3-gang  
- in accordance with EN 60669-1

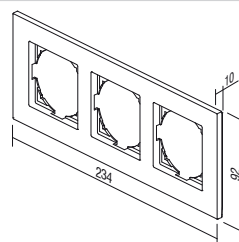

## KAPAK MBULUES PRIME 4



OR40GL  
 OR40GD

- kapak mbulues dekorativ me 4 vende  
- në përputhje me EN 60669-1

*COVER PLATE PRIME 4*

- decorative cover plate 4-gang  
- in accordance with EN 60669-1

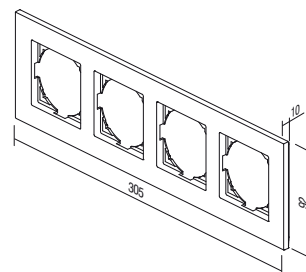



TEM

ekonomik





# ekonomik

## **PLANIFIKUAR PËR PËRSOSMËRI** **Stili është thelbësor**

Një dizajn neutral, kompakt dhe elegant mund të përshtatet me çdo ambient pune ose banimi. Nuk dallon nga ambienti i brendshëm, por në të kundërt përshtatet me të në mënyrë harmonike.

## **PLANNED FOR EXCELLENCE** **Style is essential**

A neutral, compact, elegant design is adjustable to every working or living area. It does not stick out from the interior, but rather harmonically fits into it.







# ekonomik

## HARMONIA E NGJYRAVE Zgjidhni nuancën tuaj

Dëshirat mund të jenë shumë të ndryshme. Prandaj, ne kemi zgjedhur me kujdes mundësitë për ju, që mund t'ju ofrojnë përgjigjen e duhur. Një paletë neutrale ngjyrash vetëm thjesht do ta plotësojë ambientin tuaj - nuk do ta kufizojë atë.

## HARMONY OF COLOURS Choose your hue

Desires can be very different. Therefore we have carefully selected possibilities for you, which can offer you the right answer. A neutral palette of colours will only complement your ambient - it will not restrict it.

- |                             |                               |                        |
|-----------------------------|-------------------------------|------------------------|
| <input type="checkbox"/> PW | <b>e bardhë polare</b>        | <i>polar white</i>     |
| <input type="checkbox"/> IW | <b>e bardhë fildishi</b>      | <i>ivory white</i>     |
| <input type="checkbox"/> ES | <b>e argjendte elox</b>       | <i>elox silver</i>     |
| <input type="checkbox"/> CO | <b>e bardhë termoplastike</b> | <i>white thermoset</i> |
| <input type="checkbox"/> NB | <b>e zezë mesnate</b>         | <i>night black</i>     |



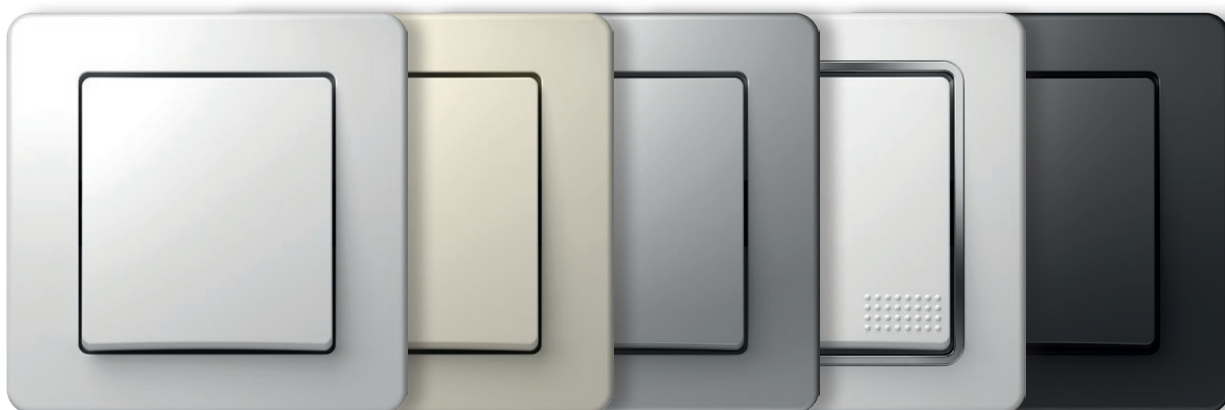

## TË THJESHTË EDHE PËR PERSONAT MË KËRKUES

Nëpërmjet planifikimit të kujdesshëm, elementet nën tension janë të mbrojtura ndaj prekjes. Fiksimi bazë i mekanizmave me kapëse fiksuese (1) lejon përforcim shtesë me vida (2). Kjo mënyrë është veçanërisht e përshtatshme për fiksimin e sigurt dhe të qëndrueshëm të prizave.

## SIMPLE FOR THE MOST DEMANDING

By careful planning elements under voltage have been protected against touching. Basic fixing of mechanisms with fixing claws (1) allows additional strengthening with screws (2). This manner is especially appropriate for safe and reliable fixing of sockets.

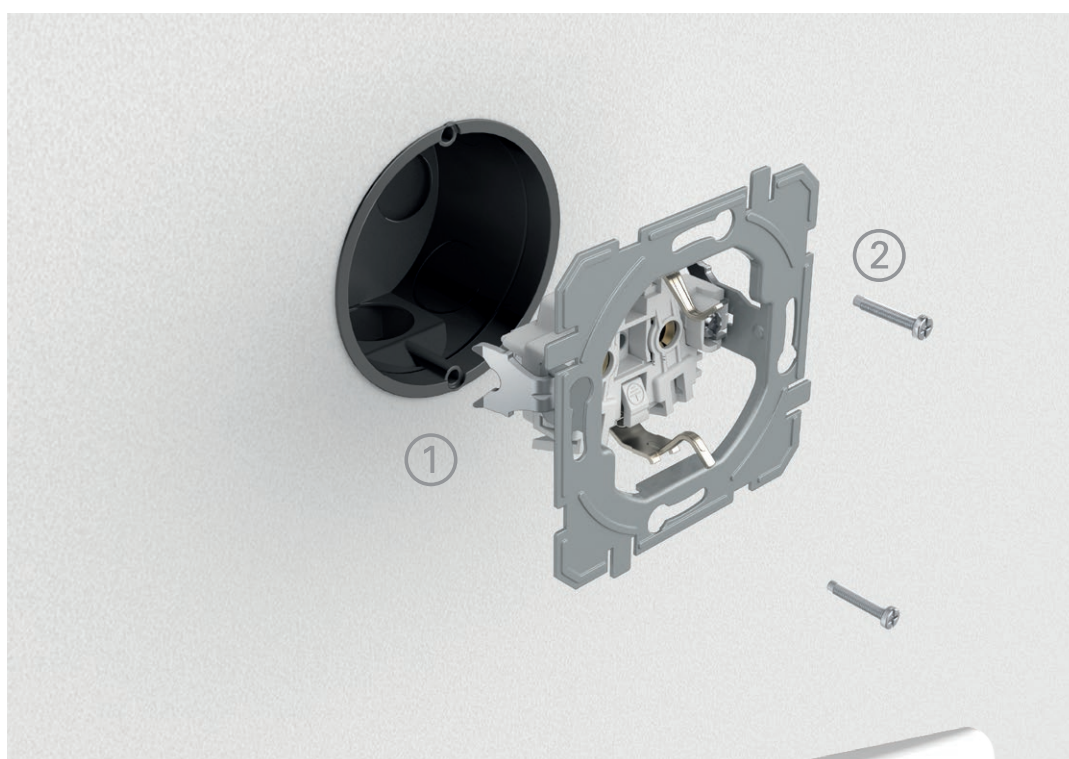

**KOMBINONI SIPAS DËSHIRËS.**  
COMBINE AS YOU PLEASE.

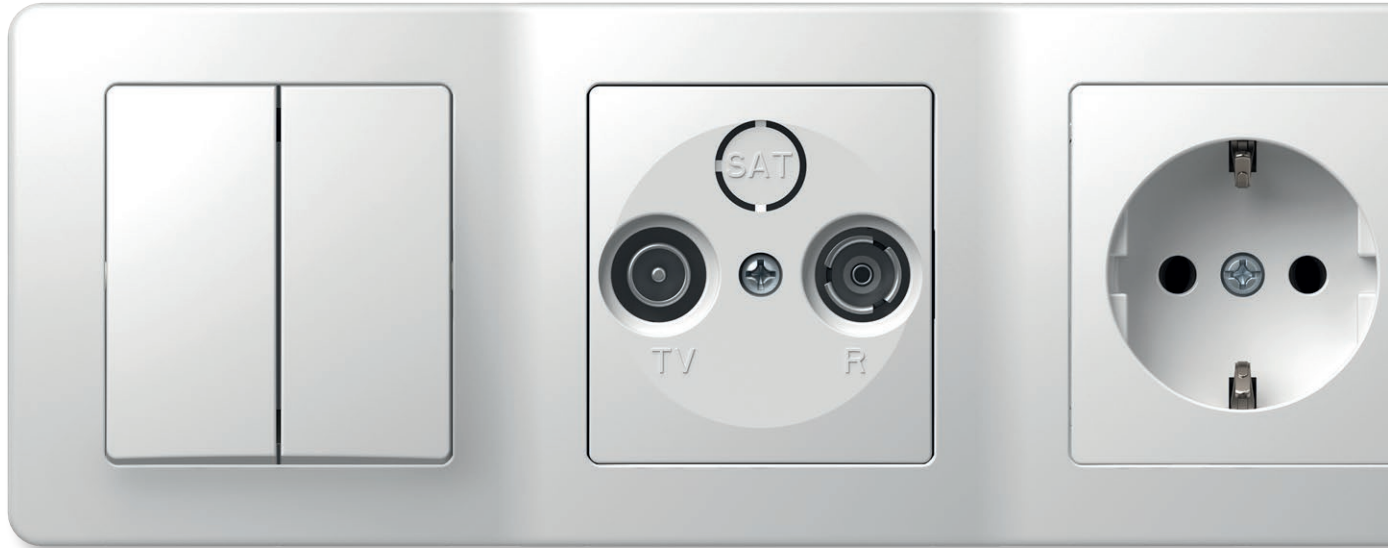

Duke kombinuar, ju kurseni hapësirë në mur.  
Kur përballeni me një hapësirë të kufizuar,  
“vertikalisht” është vendimi më i mirë.

With combining you save space on the wall.  
When faced with a limited space, »vertically«  
is the right decision.



## INSTALIM I LEHTË

Ekonomik është një zgjidhje për sistemin e kutive të standardizuara të rrumbullakëta të instalimit. Ai mund të përdoret për instalime të thjeshta, si dhe të komplikuar, ndërtesa të reja dhe përshtatje. Sistemi karakterizohet nga kontakte për futje telash që kursejnë kohë gjatë instalimit të elementeve.

## EASY INSTALLATION

Ekonomik is a solution for the system of standardized round installations boxes. It can be used for simple as well as more demanding installations, new buildings and adaptations. The system is characterised by plug-in contacts which save time during installation of elements.

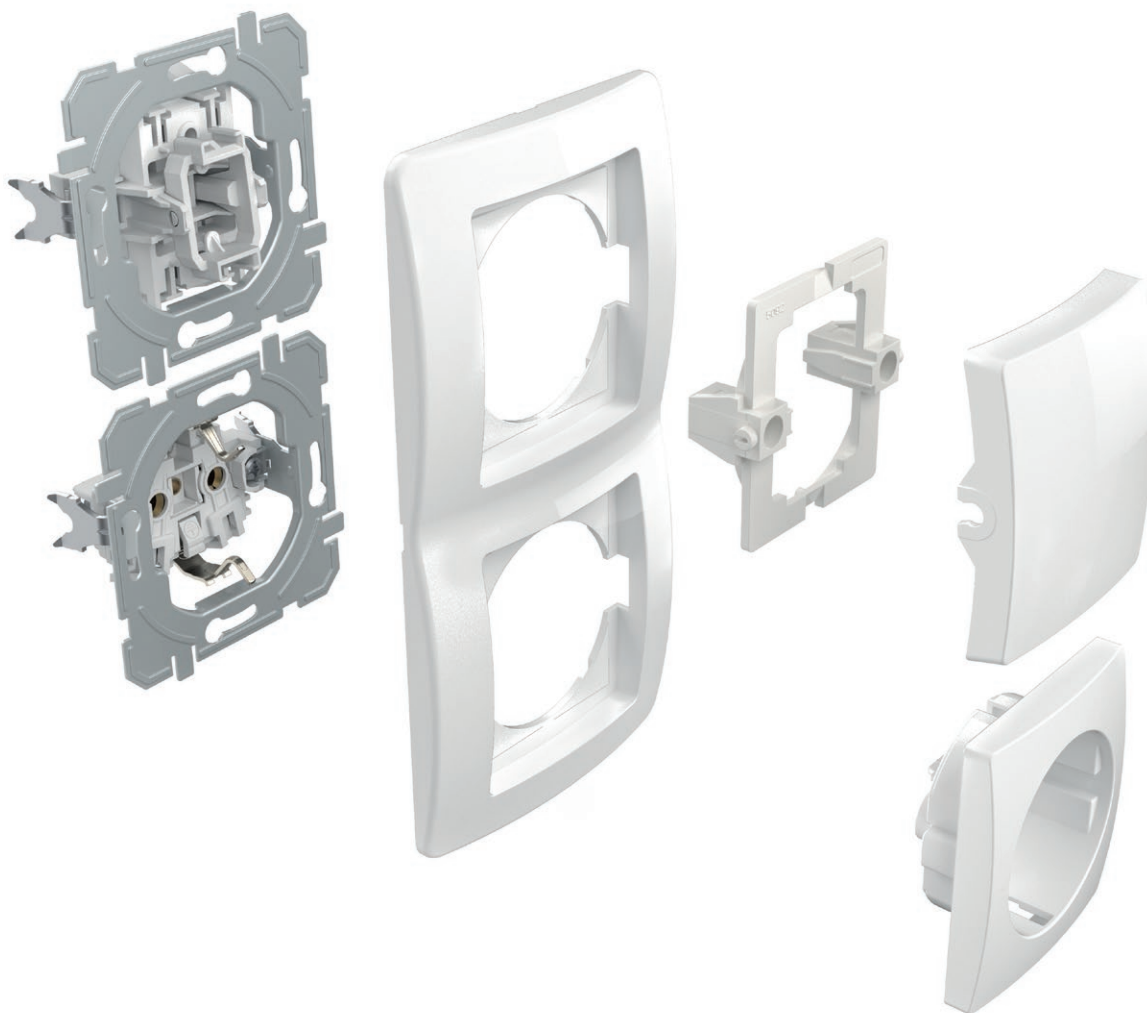

## INFORMACION I DOBISHËM

### GOOD TO KNOW



Të gjitha prizat janë të pajisura me mbyllëse sigurie që garantojnë mbrojtjen e kontakteve nën tension.

All the sockets are equipped with a safety shutters assuring the protection to live contacts.



Dizajni i mirëmenduar i çelësit mundëson integrimin e thjeshtë të treguesit, edhe në një moment të mëvonshëm.

The well-thought-out design of the switch enables the easy integration of the indication, including at a later time.



Kontaktet prej aliazhi argjendi garantojnë komutimin e sigurt.

Contacts made of silver alloy guarantee safe switching.



Kontaktet për futjen e telave mundësojnë bashkim të shpejtë dhe të sigurt të telave. Dy tela me diametër të ndryshëm mund të bashkohen me të njëjtin kontakt.

Plug-in contacts enable quick and reliable attachment of wires. Two wires of different diameters can be attached to the same contact.



Kapëset fiksuese mundësojnë fiksime më të thellë (gjithashtu përmes pllakave qeramike etj.)







Fixing claws enable deeper fixing (also through ceramic tiles, etc.)

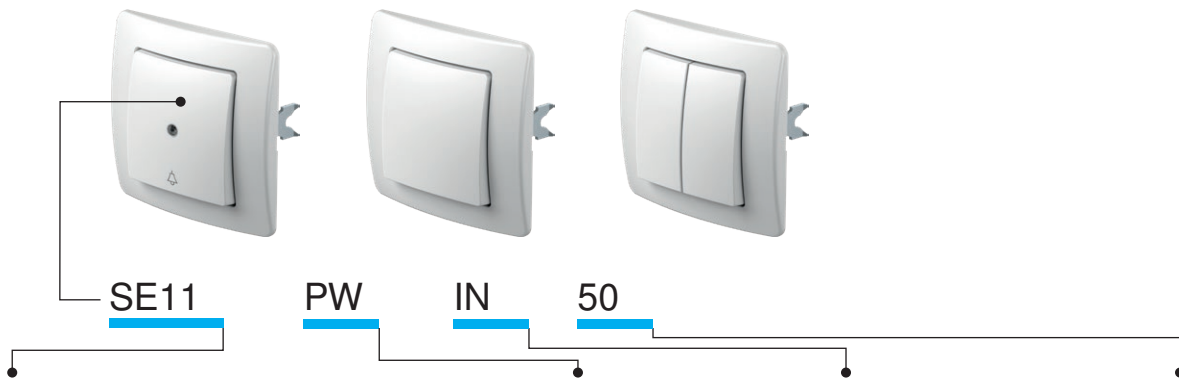

Kutitë e instalimit me montim të lehtë do t'ju lehtësojnë punën. Gjatësitë e dhura janë të garantuara.

Easy-fitting installation boxes will make your work easier. Proper lengths are guaranteed.



Iloji type	përshkrimi description	të dhënat teknike technical data	ngjyra colour	të dhënat opsionale 1 optional data 1	të dhënat opsionale 2 optional data 2
SE10	ÇELËS ME 1 DREJTIM SWITCH 1WAY	10AX 250V~	<input type="checkbox"/> PW e bardhë polare polar white	 NT neutral neutral	 50
SE11	BUTON MESHTYRJE ME 1 DREJTIM PUSH BUTTON 1WAY	10A 250V~	<input type="checkbox"/> IW e bardhë fildishi ivory white	 IN treguesi indicator	 51
SE22	ÇELËS 2 POLAR SWITCH 2POLE	16AX 250V~	<input type="checkbox"/> ES e argjendtë elox elox silver		 03
...	...	...	<input type="checkbox"/> CO termoset i bardhë white thermoset		 04
...	...	...	<input type="checkbox"/> NB e zezë mesnate night black		...

ÇELËS ME 1 DREJTIM 10 A X 250 V~

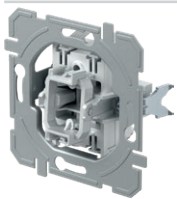

SE10

- 10 A X 250 V~, Iloji SE10
  - në përputhje me EN 60669-1
  - kontakte për futje telash 1,5-2,5 mm<sup>2</sup>
- SWITCH 1WAY 10AX 250V~
- 10AX 250V~, type SE10
  - in accordance with EN 60669-1
  - plug-in contacts 1.5-2.5mm<sup>2</sup>

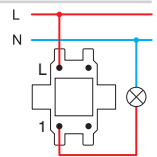

BUTON ME SHTYRJE ME 1 DREJTIM 10A 250 V~

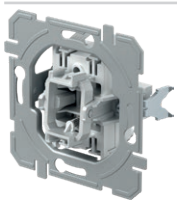

SE11

- 10A 250 V~, Iloji SE11
  - në përputhje me EN 60669-1
  - kontakte për futje telash 1,5-2,5 mm<sup>2</sup>
- PUSH BUTTON 1WAY 10A 250V~
- 10A 250V~, type SE11
  - in accordance with EN 60669-1
  - plug-in contacts 1.5-2.5mm<sup>2</sup>

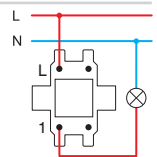
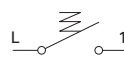

ÇELËS 2 POLAR 16 A X 250 V~

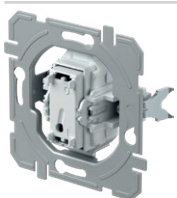

SE22

- 16 A X 250 V~, Iloji SE22
  - në përputhje me EN 60669-1
  - kontaktet e vidave 1,5-2,5 mm<sup>2</sup>
  - vetëm në kombinim me butonin TE10\_\_NT03
- SWITCH 2POLE 16AX 250V~
- 16AX 250V~, type SE22
  - in accordance with EN 60669-1
  - screw contacts 1.5-2.5mm<sup>2</sup>
  - only in combination with button TE10\_\_NT03

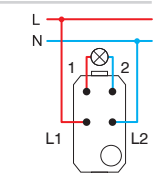
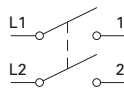

ÇELËS ME 2 POZICIONE - 1 DREJTIM 10 A X 250 V~

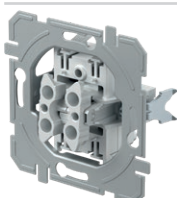

SE50

- 10 A X 250 V~, Iloji SE50
  - në përputhje me EN 60669-1
  - kontakte për futje telash 1,5-2,5 mm<sup>2</sup>
- SWITCH 2GANG-1WAY 10AX 250V~
- 10AX 250V~, type SE50
  - in accordance with EN 60669-1
  - plug-in contacts 1.5-2.5mm<sup>2</sup>

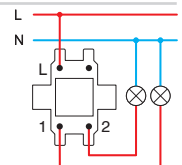
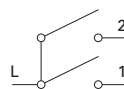

## S W I T C H E S S E

## BUTON ME SHYTPJE ME 2 POZICIONE - 1 DREJTIM 10A 250 V~

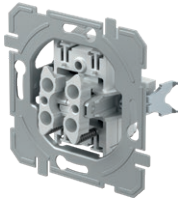

SE51

- 10 A 250 V~, Iloji SE51
- në përputhje me EN 60669-1
- kontakte për futje telash 1,5-2,5 mm<sup>2</sup>

*PUSH BUTTON 2GANG-1WAY 10A 250V~*

- 10A 250V~, type SE51
- in accordance with EN 60669-1
- plug-in contacts 1.5-2.5mm<sup>2</sup>

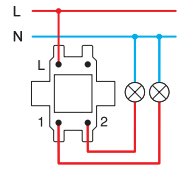
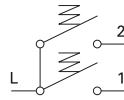

## MBYLLËSE ÇELËSI 10 A X 250 V~

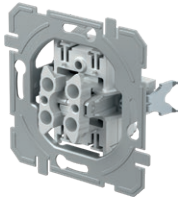

SE52

- 10 A X 250 V~, Iloji SE52
- në përputhje me EN 60669-1
- kontakte për futje telash 1,5-2,5 mm<sup>2</sup>
- me bllokim mekanik

*SWITCH SHUTTERS 10AX 250V~*

- 10AX 250V~, type SE52
- in accordance with EN 60669-1
- plug-in contacts 1.5-2.5mm<sup>2</sup>
- with mechanical interblock

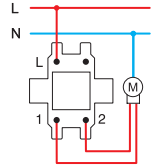
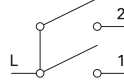

## MBYLLËSE BUTONI ME SHYTPJE 10 A 250 V~

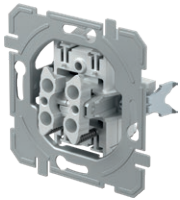

SE53

- 10A 250 V~, Iloji SE53
- në përputhje me EN 60669-1
- kontakte për futje telash 1,5-2,5 mm<sup>2</sup>
- me bllokim mekanik

*PUSH BUTTON SHUTTERS 10A 250V~*

- 10A 250V~, type SE53
- in accordance with EN 60669-1
- plug-in contacts 1.5-2.5mm<sup>2</sup>
- with mechanical interblock

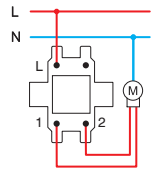
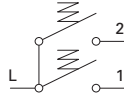

## ÇELËS ME 2 DREJTIME 10 A X 250 V~

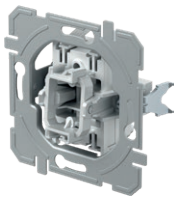

SE60

- 10 A X 250 V~, Iloji SE60
- në përputhje me EN 60669-1
- kontakte për futje telash 1,5-2,5 mm<sup>2</sup>

*SWITCH 2WAY 10AX 250V~*

- 10AX 250V~, type SE60
- in accordance with EN 60669-1
- plug-in contacts 1.5-2.5mm<sup>2</sup>

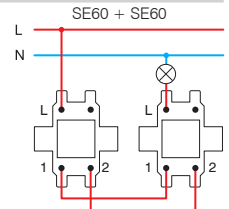
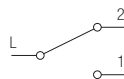

## ÇELËS DYSH ME 2 DREJTIME 10 A X 250 V~

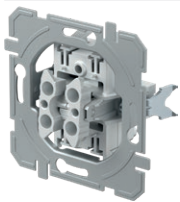

SE63

- 10 A X 250 V~, Iloji SE63
- në përputhje me EN 60669-1
- kontakte për futje telash 1,5-2,5 mm<sup>2</sup>

*SWITCH DOUBLE 2WAY 10AX 250V~*

- 10AX 250V~, type SE63
- in accordance with EN 60669-1
- plug-in contacts 1.5-2.5mm<sup>2</sup>

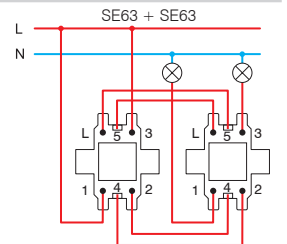

## ÇELËS NDËRMJETËS 10 A X 250 V~

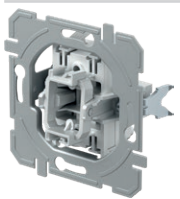

SE70

- 10 A X 250 V~, Iloji SE70
- në përputhje me EN 60669-1
- kontakte për futje telash 1,5-2,5 mm<sup>2</sup>

*SWITCH INTERMEDIATE 10AX 250V~*

- 10AX 250V~, type SE70
- in accordance with EN 60669-1
- plug-in contacts 1.5-2.5mm<sup>2</sup>

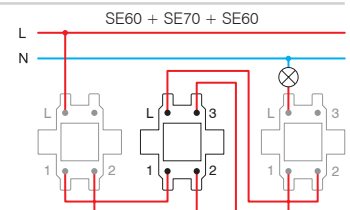



ÇELËS ME 1 DREJTIM 10 A X 250 V~



- SE10PW
- SE10IW
- SE10ES
- SE10CO
- SE10NB

- 10 A X 250 V~, Iloji SE10
- në përputhje me EN 60669-1
- kontakte për futje telash 1,5-2,5 mm<sup>2</sup>

*SWITCH 1WAY 10AX 250V~*  
 - 10AX 250V~, type SE10  
 - in accordance with EN 60669-1  
 - plug-in contacts 1.5-2.5mm<sup>2</sup>



ÇELËS ME 1 DREJTIM 10 A X 250 V~ \_\_ IN



- SE10PWIN
- SE10IWIN
- SE10ESIN
- SE10COIN
- SE10NBIN

- IN tregues
- 10 A X 250 V~, Iloji SE10
- në përputhje me EN 60669-1
- kontakte për futje telash 1,5-2,5 mm<sup>2</sup>

*SWITCH 1WAY 10AX 250V~ \_\_ IN*  
 - IN indicator  
 - 10AX 250V~, type SE10  
 - in accordance with EN 60669-1  
 - plug-in contacts 1.5-2.5mm<sup>2</sup>



BUTON ME SHTYPJE ME 1 DREJTIM 10A 250 V~



- SE11PW
- SE11IW
- SE11ES
- SE11CO
- SE11NB

- 10A 250 V~, Iloji SE11
- në përputhje me EN 60669-1
- kontakte për futje telash 1,5-2,5 mm<sup>2</sup>

*PUSH BUTTON 1WAY 10A 250V~*  
 - 10A 250V~, type SE11  
 - in accordance with EN 60669-1  
 - plug-in contacts 1.5-2.5mm<sup>2</sup>



BUTON ME SHTYPJE ME 1 DREJTIM 10 A 250 V~ \_\_ TI 50



- SE11PWTI50
- SE11IWTI50
- SE11ESTI50
- SE11COTI50
- SE11NBTI50

- TI 50 zile treguese+llambë neoni
- 10A 250 V~, Iloji SE11
- në përputhje me EN 60669-1
- kontakte për futje telash 1,5-2,5 mm<sup>2</sup>

*PUSH BUTTON 1WAY 10A 250V~ \_\_ TI 50*  
 - TI 50 indicator bell+neon lamp  
 - 10A 250V~, type SE11  
 - in accordance with EN 60669-1  
 - plug-in contacts 1.5-2.5mm<sup>2</sup>



BUTON ME SHTYPJE ME 1 DREJTIM 10 A 250 V~ \_\_ TI 51



- SE11PWTI51
- SE11IWTI51
- SE11ESTI51
- SE11COTI51
- SE11NBTI51

- TI 51 dritë treguese+llambë neoni
- 10A 250 V~, Iloji SE11
- në përputhje me EN 60669-1
- kontakte për futje telash 1,5-2,5 mm<sup>2</sup>

*PUSH BUTTON 1WAY 10A 250V~ \_\_ TI 51*  
 - TI 51 indicator light+neon lamp  
 - 10A 250V~, type SE11  
 - in accordance with EN 60669-1  
 - plug-in contacts 1.5-2.5mm<sup>2</sup>



BUTON ME SHTYPJE ME 1 DREJTIM 10 A 250 V~ \_\_ IL



- SE11PWIL
- SE11IWIL
- SE11ESIL
- SE11COIL
- SE11NBIL

- IL pllakë me mbishkrim
- 10A 250 V~, Iloji SE11
- në përputhje me EN 60669-1
- kontakte për futje telash 1,5-2,5 mm<sup>2</sup>

*PUSH BUTTON 1WAY 10A 250V~ \_\_ IL*  
 - IL inscription plate  
 - 10A 250V~, type SE11  
 - in accordance with EN 60669-1  
 - plug-in contacts 1.5-2.5mm<sup>2</sup>



ÇELËS 2 POLAR 16 A X 250 V~ \_\_ IN 03



- SE22PWIN03
- SE22IWIN03
- SE22ESIN03
- SE22NBIN03

- IN 03 neutral 0-1
- 16 A X 250 V~, Iloji SE22
- në përputhje me EN 60669-1
- kontaktet e vidave 1,5-2,5 mm<sup>2</sup>

*SWITCH 2POLE 16AX 250V~ \_\_ IN 03*  
 - IN 03 neutral 0-1  
 - 16AX 250V~, type SE22  
 - in accordance with EN 60669-1  
 - screw contacts 1.5-2.5mm<sup>2</sup>



## S W I T C H E S S E

	<ul style="list-style-type: none"> <li><input type="checkbox"/> SE50PW</li> <li><input type="checkbox"/> SE50IW</li> <li><input type="checkbox"/> SE50ES</li> <li><input type="checkbox"/> SE50CO</li> <li><input checked="" type="checkbox"/> SE50NB</li> </ul>	<b>ÇELËS ME 2 POZICIONE - 1 DREJTIM 10 A X 250 V~</b>	<ul style="list-style-type: none"> <li>- 10 A X 250 V~, Iloji SE50</li> <li>- në përputhje me EN 60669-1</li> <li>- kontakte për futje telash 1,5-2,5 mm<sup>2</sup></li> </ul>	
	<ul style="list-style-type: none"> <li><input type="checkbox"/> SE51PW</li> <li><input type="checkbox"/> SE51IW</li> <li><input type="checkbox"/> SE51ES</li> <li><input type="checkbox"/> SE51CO</li> <li><input checked="" type="checkbox"/> SE51NB</li> </ul>	<b>BUTON ME SHTYPJE ME 2 POZICIONE - 1 DREJTIM 10A 250 V~</b>	<ul style="list-style-type: none"> <li>- 10 A 250 V~, Iloji SE51</li> <li>- në përputhje me EN 60669-1</li> <li>- kontakte për futje telash 1,5-2,5 mm<sup>2</sup></li> </ul>	
	<ul style="list-style-type: none"> <li><input type="checkbox"/> SE52PWNT09</li> <li><input type="checkbox"/> SE52IWNT09</li> <li><input type="checkbox"/> SE52ESNT09</li> <li><input type="checkbox"/> SE52CONT09</li> <li><input checked="" type="checkbox"/> SE52NBNT09</li> </ul>	<b>MBYLLËSE ÇELËSI 10 A X 250 V~ __ NT 09</b>	<ul style="list-style-type: none"> <li>- NT 09 neutral lart-poshtë</li> <li>- 10 A X 250 V~, Iloji SE52</li> <li>- në përputhje me EN 60669-1</li> <li>- kontakte për futje telash 1,5-2,5 mm<sup>2</sup></li> <li>- me bllokim mekanik</li> </ul>	
	<ul style="list-style-type: none"> <li><input type="checkbox"/> SE53PWNT09</li> <li><input type="checkbox"/> SE53IWNT09</li> <li><input type="checkbox"/> SE53ESNT09</li> <li><input type="checkbox"/> SE53CONT09</li> <li><input checked="" type="checkbox"/> SE53NBNT09</li> </ul>	<b>MBYLLËSE BUTONI ME SHTYPJE 10 A 250 V~ __ NT 09</b>	<ul style="list-style-type: none"> <li>- NT 09 neutral lart-poshtë</li> <li>- 10A 250 V~, Iloji SE53</li> <li>- në përputhje me EN 60669-1</li> <li>- kontakte për futje telash 1,5-2,5 mm<sup>2</sup></li> <li>- me bllokim mekanik</li> </ul>	
	<ul style="list-style-type: none"> <li><input type="checkbox"/> SE60PW</li> <li><input type="checkbox"/> SE60IW</li> <li><input type="checkbox"/> SE60ES</li> <li><input type="checkbox"/> SE60CO</li> <li><input checked="" type="checkbox"/> SE60NB</li> </ul>	<b>ÇELËS ME 2 DREJTIME 10 A X 250 V~</b>	<ul style="list-style-type: none"> <li>- 10 A X 250 V~, Iloji SE60</li> <li>- në përputhje me EN 60669-1</li> <li>- kontakte për futje telash 1,5-2,5 mm<sup>2</sup></li> </ul>	
	<ul style="list-style-type: none"> <li><input type="checkbox"/> SE63PW</li> <li><input type="checkbox"/> SE63IW</li> <li><input type="checkbox"/> SE63ES</li> <li><input type="checkbox"/> SE63CO</li> <li><input checked="" type="checkbox"/> SE63NB</li> </ul>	<b>ÇELËS DYSH ME 2 DREJTIME 10 A X 250 V~</b>	<ul style="list-style-type: none"> <li>- 10 A X 250 V~, Iloji SE63</li> <li>- në përputhje me EN 60669-1</li> <li>- kontakte për futje telash 1,5-2,5 mm<sup>2</sup></li> </ul>	
	<ul style="list-style-type: none"> <li><input type="checkbox"/> SE70PW</li> <li><input type="checkbox"/> SE70IW</li> <li><input type="checkbox"/> SE70ES</li> <li><input type="checkbox"/> SE70CO</li> <li><input checked="" type="checkbox"/> SE70NB</li> </ul>	<b>ÇELËS NDËRMJETËS 10 A X 250 V~</b>	<ul style="list-style-type: none"> <li>- 10 A X 250 V~, Iloji SE70</li> <li>- në përputhje me EN 60669-1</li> <li>- kontakte për futje telash 1,5-2,5 mm<sup>2</sup></li> </ul>	

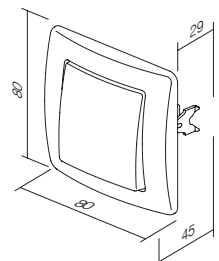
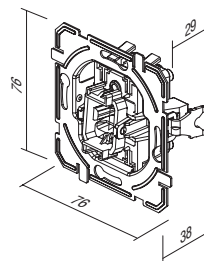

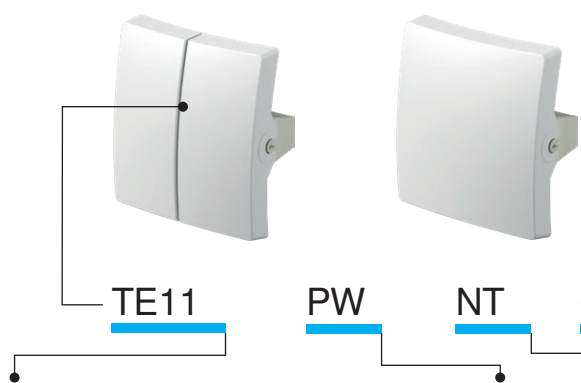

Iloji type	përshkrimi description	ngjyra colour	të dhënat opsionale 1 optional data 1	të dhënat opsionale 2 optional data 2
TE10	BUTON ME 1 POZICION BUTTON 1GANG	<input type="checkbox"/> PW e bardhë polare polar white	NT neutral neutral	50
TE11	BUTON ME 2 POZICIONE BUTTON 2GANG	<input type="checkbox"/> IW e bardhë fildishi ivory white	IN treguesi indicator	51
...	...	<input type="checkbox"/> ES e argjendtë elox elox silver		03
...	...	<input type="checkbox"/> CO termoset i bardhë white thermoset		04
...	...	<input type="checkbox"/> NB e zezë mesnate night black		...

**BUTON ME 1 POZICION**



- TE10PW
- TE10IW
- TE10ES
- TE10CO
- TE10NB

- buton bashkë me mbajtësen

**BUTTON 1GANG**

- button together with carrier



**TREGUES BUTONI**

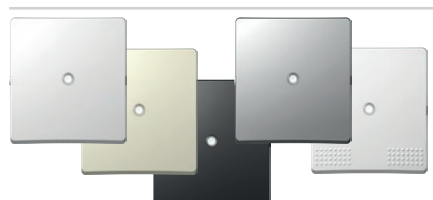

- TE10PWIN
- TE10IWIN
- TE10ESIN
- TE10COIN
- TE10NBIN

- buton bashkë me mbajtësen

**BUTTON INDICATOR**

- button together with carrier



**BUTON ME KAPAK ME MBISHKRIM**

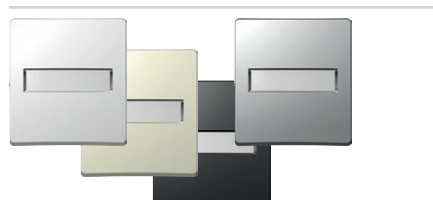

- TE13PWIL
- TE13IWIL
- TE13ESIL
- TE13NBIL

- buton bashkë me mbajtësen, me pllakë me mbishkrim

**BUTTON WITH INSCRIPTION PLATE**

- button together with carrier, with inscription plate



**BUTON ME 2 POZICIONE**



- TE11PW
- TE11IW
- TE11ES
- TE11CO
- TE11NB

- butoni me 2 pozicione bashkë me mbajtësen

**BUTTON 2GANG**

- button 2gang together with carrier

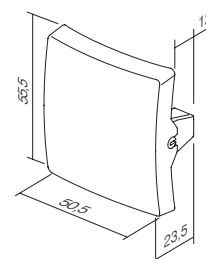
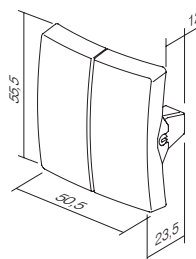

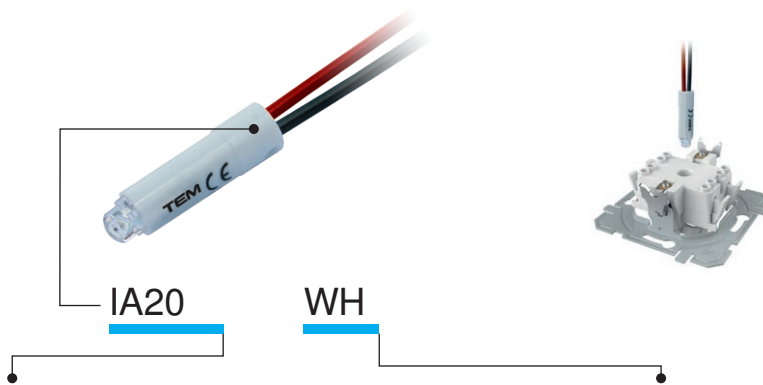

Iloji type	përshkrimi description	të dhënat teknike technical data	ngjyra colour
IA10	LLAMBË NEONI NEON LAMP	230V~ 0,34W	<input type="checkbox"/> WH e bardhë white
IA20	LLAMBË LED LED SIGNALLING UNIT	230V~ 0,40W	<input checked="" type="checkbox"/> BL blu blue
IA21	LLAMBË LED LED SIGNALLING UNIT	24V AC/DC 0,20W	<input checked="" type="checkbox"/> RD e kuqe red
·	·	·	<input checked="" type="checkbox"/> GR e gjelbër green
·	·	·	<input checked="" type="checkbox"/> OR portokalli orange

#### LLAMBË NEONI 230 V~ 0,34 W

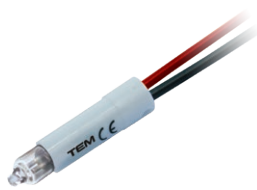

IA10OR

- për indikim, sinjalizim ose sinjalizim të përhershëm
- në kombinim me një buton që ka një tregues

*NEON LAMP 230V~ 0,34W*

- for indication, signalling or permanent signalling
- in combination with a button featuring an indicator

#### SINJALIZIMI LED 230 V AC/DC 0,40 W

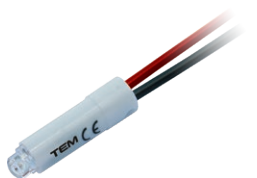

IA20WH  
 IA20GR  
 IA20RD  
 IA20BL

- për indikim, sinjalizim ose sinjalizim të përhershëm
- në kombinim me një buton që ka një tregues

*LED SIGNALLING UNIT 230V AC/DC 0,40W*

- for indication, signalling or permanent signalling
- in combination with a button featuring an indicator

#### SINJALIZIMI LED 24V AC/DC 0,20W

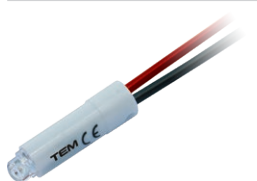

IA21WH  
 IA21RD

- për indikim, sinjalizim ose sinjalizim të përhershëm
- në kombinim me një buton që ka një tregues

*LED SIGNALLING UNIT 24V AC/DC 0,20W*

- for indication, signalling or permanent signalling
- in combination with a button featuring an indicator

#### SINJALIZIMI LED 12V AC/DC 0,10W

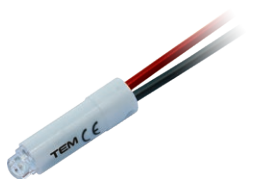

IA22WH  
 IA22RD

- për indikim, sinjalizim ose sinjalizim të përhershëm
- në kombinim me një buton që ka një tregues

*LED SIGNALLING UNIT 12V AC/DC 0,10W*

- for indication, signalling or permanent signalling
- in combination with a button featuring an indicator



Treguesi /  
Indication

\* Sinjalizimi /  
Signalization

Sinjalizimi i përhershëm /  
Permanent signalling

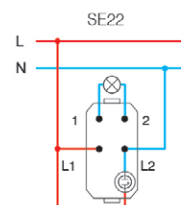
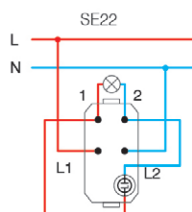
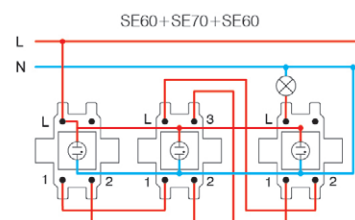
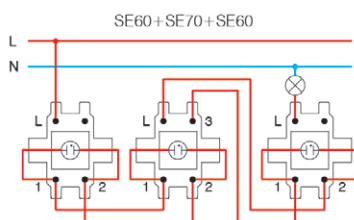
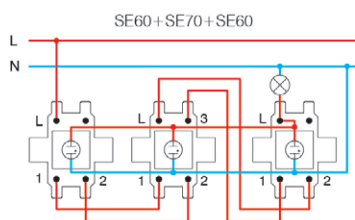
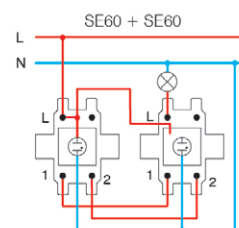
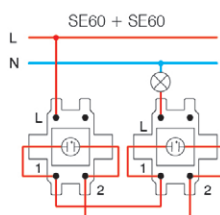
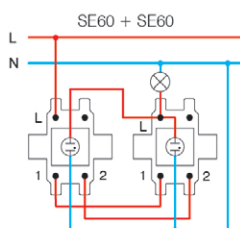
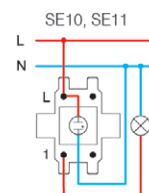
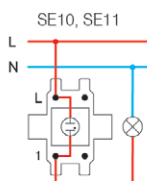
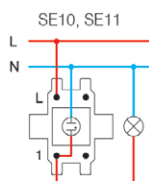

\* lidhjet nuk janë të përshtatshme për llambat që kursejnë energji (CFL, LED) /  
the connections are not suitable for energy-saving bulbs (CFL, LED)

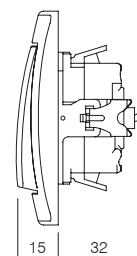

## S O C K E T S V E

**VE11**      **PT**      **XO**      **KS**

lloji type	përshkrimi description	të dhënat teknike technical data	të dhënat opsionale 1 optional data 1	të dhënat opsionale 2 optional data 2
VE10	PRIZË SCHUKO SOCKET SCHUKO	2P+E 16A 250V~	XO pa kapak mbulues without cover plate	KS kontaktet me rrymën të mbuluara shuttered live contacts
VE11	PRIZË SCHUKO+KAPAK SOCKET SCHUKO+COVER	2P+E 16A 250V~		
VE12	PRIZË SCHUKO SOCKET SCHUKO	2P+E 16A 250V~ BV	KS kontaktet me rrymën të mbuluara shuttered live contacts	
⋮	⋮	⋮		

ngjyra  
colour

<input type="checkbox"/> PW e bardhë polare polar white	<input checked="" type="checkbox"/> PT e bardhë+transparente white+transparent	<input type="checkbox"/> PP e bardhë+e bardhë white+white
<input checked="" type="checkbox"/> IW e bardhë fildishi ivory white	<input checked="" type="checkbox"/> IT e fildishtë+transparente ivory+transparent	<input checked="" type="checkbox"/> II e fildishtë+e fildishtë ivory+ivory
<input type="checkbox"/> ES e argjendtë elox elox silver	<input checked="" type="checkbox"/> ST e argjendtë+transparente silver+transparent	<input type="checkbox"/> SS e argjendtë+e argjendtë silver+silver
<input type="checkbox"/> CO termoset i bardhë white thermoset	<input type="checkbox"/> CT e bardhë+transparente white+transparent	<input checked="" type="checkbox"/> BB e zezë+e zezë black+black
<input checked="" type="checkbox"/> NB e zezë mesnate night black	<input checked="" type="checkbox"/> BT e zezë+transparente black+transparent	<input checked="" type="checkbox"/> RR e kuqe+e kuqe red+red
<input checked="" type="checkbox"/> RD e kuqe red	<input checked="" type="checkbox"/> RT e kuqe+transparente red+transparent	<input checked="" type="checkbox"/> GG e gjelbër+e gjelbër green+green
<input checked="" type="checkbox"/> GR e gjelbër green	<input checked="" type="checkbox"/> GT e gjelbër+transparente green+transparent	<input checked="" type="checkbox"/> OO portokalli+portokalli orange+orange
<input checked="" type="checkbox"/> OR portokalli orange	<input checked="" type="checkbox"/> OT portokalli+transparente orange+transparent	



schuko - në përputhje me EN 60884-1, CEE7 (fleta e standardit III)

Franceze - në përputhje me NF C 61-314 (fleta e standardit V)

schuko - in accordance with EN 60884-1, CEE7 (standard sheet III)

French - in accordance with NF C 61-314 (standard sheet V)

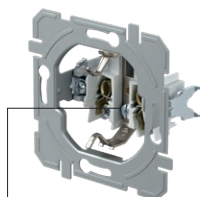

kontaktet e vidave  
screw contacts

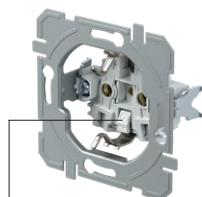

kontaktet për futje telash BV  
BV plug-in contacts

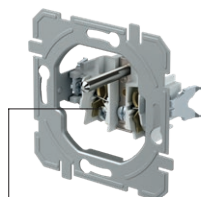

kontaktet e vidave  
screw contacts

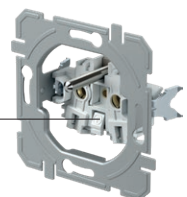

kontaktet për futje telash BV  
BV plug-in contacts

PRIZË SCHUKO 2P+E 16 A 250 V~ \_\_ XO

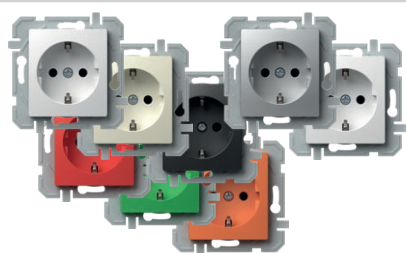

- VE10PWXO
- VE10IWXO
- VE10ESXO
- VE10COXO
- VE10NBXO
- VE10RDXO
- VE10GRXO
- VE10ORXO

- kontaktet e vidave 1,5-2,5 mm<sup>2</sup>
- XO pa kapak mbulues
- 2P+E schuko
- 16 A 250 V~, Iloji VE10

SOCKET SCHUKO 2P+E 16A 250V~ \_\_ XO

- screw contacts 1.5-2.5mm<sup>2</sup>
- XO without surround
- 2P+E schuko
- 16A 250V~, type VE10



PRIZË SCHUKO+KAPAK 2P+E 16 A 250 V~ \_\_ XO



- VE11PTXO
- VE11ITXO
- VE11STXO
- VE11BTXO

- kontaktet e vidave 1,5-2,5 mm<sup>2</sup>
- XO pa kapak mbulues
- 2P+E schuko+kapak
- 16 A 250 V~, Iloji VE11

SOCKET SCHUKO+COVER 2P+E 16A 250V~ \_\_ XO

- screw contacts 1.5-2.5mm<sup>2</sup>
- XO without surround
- 2P+E schuko+cover
- 16A 250V~, type VE11



PRIZË SCHUKO 2P+E 16 A 250 V~ BV \_\_ XO



- VE12PWXO
- VE12IWXO
- VE12ESXO
- VE12COXO
- VE12NBXO
- VE12RDXO
- VE12GRXO
- VE12ORXO

- BV kontakte për futje telash 1,5-2,5 mm<sup>2</sup>
- XO pa kapak mbulues
- 2P+E schuko
- 16 A 250 V~, Iloji VE12

SOCKET SCHUKO 2P+E 16A 250V~ BV \_\_ XO

- BV plug-in contacts 1.5-2.5mm<sup>2</sup>
- XO without surround
- 2P+E schuko
- 16A 250V~, type VE12



PRIZË SCHUKO+KAPAK 2P+E 16 A 250 V~ BV \_\_ XO

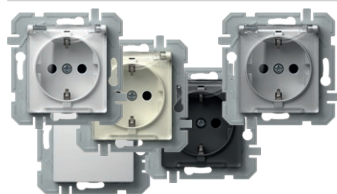

- VE13PTXO
- VE13ITXO
- VE13STXO
- VE13BTXO
- VE13PPXO

- BV kontakte për futje telash 1,5-2,5 mm<sup>2</sup>
- XO pa kapak mbulues
- 2P+E schuko+kapak
- 16 A 250 V~, Iloji VE13

SOCKET SCHUKO+COVER 2P+E 16A 250V~ BV \_\_ XO

- BV plug-in contacts 1.5-2.5mm<sup>2</sup>
- XO without surround
- 2P+E schuko+cover
- 16A 250V~, type VE13



PRIZË SCHUKO 2P+E 16 A 250 V~



- VE10PW
- VE10IW
- VE10ES
- VE10CO
- VE10NB

- kontaktet e vidave 1,5-2,5 mm<sup>2</sup>
- 2P+E schuko
- 16 A 250 V~, Iloji VE10

SOCKET SCHUKO 2P+E 16A 250V~

- screw contacts 1.5-2.5mm<sup>2</sup>
- 2P+E schuko
- 16A 250V~, type VE10



PRIZË SCHUKO+KAPAK 2P+E 16 A 250 V~



- VE11PT
- VE11IT
- VE11ST
- VE11CT
- VE11BT

- kontaktet e vidave 1,5-2,5 mm<sup>2</sup>
- 2P+E schuko+kapak
- 16 A 250 V~, Iloji VE11

SOCKET SCHUKO+COVER 2P+E 16A 250V~

- screw contacts 1.5-2.5mm<sup>2</sup>
- 2P+E schuko+cover
- 16A 250V~, type VE11



PRIZË SCHUKO 2P+E 16 A 250 V~ BV



- VE12PW
- VE12IW
- VE12ES
- VE12CO
- VE12NB

- BV kontakte për futje telash 1,5-2,5 mm<sup>2</sup>
- 2P+E schuko
- 16 A 250 V~, Iloji VE12

SOCKET SCHUKO 2P+E 16A 250V~ BV

- BV plug-in contacts 1.5-2.5mm<sup>2</sup>
- 2P+E schuko
- 16A 250V~, type VE12



PRIZË SCHUKO+KAPAK 2P+E 16 A 250 V~ BV



- VE13PT
- VE13IT
- VE13ST
- VE13CT
- VE13BT

- BV kontakte për futje telash 1,5-2,5 mm<sup>2</sup>
- 2P+E schuko+kapak
- 16 A 250 V~, Iloji VE13

SOCKET SCHUKO+COVER 2P+E 16A 250V~ BV

- BV plug-in contacts 1.5-2.5mm<sup>2</sup>
- 2P+E schuko+cover
- 16A 250V~, type VE13



## S O C K E T S V E

## PRIZË FRANCEZE 2P+E 16 A 250 V~ \_\_ XO

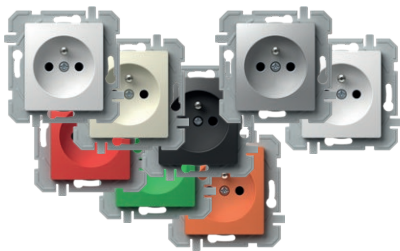

- VE40PWXO
- VE40IWXO
- VE40ESXO
- VE40COXO
- VE40NBXO
- VE40RDXO
- VE40GRXO
- VE40ORXO

- kontaktet e vidave 1,5-2,5 mm<sup>2</sup>
- XO pa kapak mbulues
- 2P+E Franceze
- 16 A 250 V~, lloji VE40

## SOCKET FRENCH 2P+E 16A 250V~ \_\_ XO

- screw contacts 1.5-2.5mm<sup>2</sup>
- XO without surround
- 2P+E French
- 16A 250V~, type VE40



## PRIZË FRANCEZE+KAPAK 2P+E 16 A 250 V~ \_\_ XO

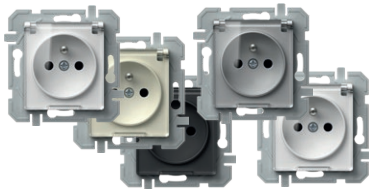

- VE41PTXO
- VE41ITXO
- VE41STXO
- VE41BTXO
- VE41PPXO

- kontaktet e vidave 1,5-2,5 mm<sup>2</sup>
- XO pa kapak mbulues
- 2P+E Franceze+kapak
- 16 A 250 V~, lloji VE41

## SOCKET FRENCH+COVER 2P+E 16A 250V~ \_\_ XO

- screw contacts 1.5-2.5mm<sup>2</sup>
- XO without surround
- 2P+E French+cover
- 16A 250V~, type VE41



## PRIZË FRANCEZE 2P+E 16 A 250 V~ BV \_\_ XO

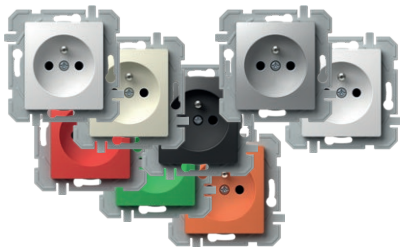

- VE42PWXO
- VE42IWXO
- VE42ESXO
- VE42COXO
- VE42NBXO
- VE42RDXO
- VE42GRXO
- VE42ORXO

- BV kontakte për futje telash 1,5-2,5 mm<sup>2</sup>
- XO pa kapak mbulues
- 2P+E Franceze
- 16 A 250 V~, lloji VE42

## SOCKET FRENCH 2P+E 16A 250V~ BV \_\_ XO

- BV plug-in contacts 1.5-2.5mm<sup>2</sup>
- XO without surround
- 2P+E French
- 16A 250V~, type VE42



## PRIZË FRANCEZE+KAPAK 2P+E 16 A 250 V~ BV \_\_ XO



- VE43PTXO
- VE43ITXO
- VE43STXO
- VE43BTXO
- VE43PPXO

- BV kontakte për futje telash 1,5-2,5 mm<sup>2</sup>
- XO pa kapak mbulues
- 2P+E Franceze+kapak
- 16 A 250 V~, lloji VE43

## SOCKET FRENCH+COVER 2P+E 16A 250V~ BV \_\_ XO

- BV plug-in contacts 1.5-2.5mm<sup>2</sup>
- XO without surround
- 2P+E French+cover
- 16A 250V~, type VE43



## PRIZË FRANCEZE 2P+E 16 A 250 V~



- VE40PW
- VE40IW
- VE40ES
- VE40CO
- VE40NB

- kontaktet e vidave 1,5-2,5 mm<sup>2</sup>
- 2P+E Franceze
- 16 A 250 V~, lloji VE40

## SOCKET FRENCH 2P+E 16A 250V~

- screw contacts 1.5-2.5mm<sup>2</sup>
- 2P+E French
- 16A 250V~, type VE40



## PRIZË FRANCEZE+KAPAK 2P+E 16 A 250 V~



- VE41PT
- VE41IT
- VE41BT
- VE41ST

- kontaktet e vidave 1,5-2,5 mm<sup>2</sup>
- 2P+E Franceze+kapak
- 16 A 250 V~, lloji VE41

## SOCKET FRENCH+COVER 2P+E 16A 250V~

- screw contacts 1.5-2.5mm<sup>2</sup>
- 2P+E French+cover
- 16A 250V~, type VE41



## PRIZË FRANCEZE 2P+E 16 A 250 V~ BV



- VE42PW
- VE42IW
- VE42ES
- VE42CO
- VE42NB

- BV kontakte për futje telash 1,5-2,5 mm<sup>2</sup>
- 2P+E Franceze
- 16 A 250 V~, lloji VE42

## SOCKET FRENCH 2P+E 16A 250V~ BV

- BV plug-in contacts 1.5-2.5mm<sup>2</sup>
- 2P+E French
- 16A 250V~, type VE42



## PRIZË FRANCEZE+KAPAK 2P+E 16 A 250 V~ BV



- VE43PT
- VE43IT
- VE43BT
- VE43ST

- BV kontakte për futje telash 1,5-2,5 mm<sup>2</sup>
- 2P+E Franceze+kapak
- 16 A 250 V~, lloji VE43

## SOCKET FRENCH+COVER 2P+E 16A 250V~ BV

- BV plug-in contacts 1.5-2.5mm<sup>2</sup>
- 2P+E French+cover
- 16A 250V~, type VE43





PRIZË SCHUKO DYSHE 2P+E 16 A 250 V~



- VE16PWKS
- VE16WKS
- VE16ESKS
- VE16NBKS

- 2P+E schuko dyshe
- 16 A 250 V~, lloji VE16
- në përputhje me IEC 60884-1, CEE7
- kontaktet e vidave 1,5-2,5 mm<sup>2</sup>
- kontaktet me rrymën të mbuluara

SOCKET SCHUKO DOUBLE 2P+E 16A 250V~

- 2P+E schuko double
- 16A 250V~, type VE16
- in accordance with IEC 60884-1, CEE7
- screw contacts 1.5-2.5 mm<sup>2</sup>
- shuttered live contacts



PRIZË FRANCEZE DYSHE 2P+E 16 A 250 V~



- VE46PWKS
- VE46WKS
- VE46ESKS
- VE46NBKS

- 2P+E franceze dyshe
- 16 A 250 V~, lloji VE46
- në përputhje me IEC 60884-1, CEE7; NF C 61-314, ČSN 33 2318; PN-E 93201
- kontaktet e vidave 1,5-2,5 mm<sup>2</sup>
- kontaktet me rrymën të mbuluara

SOCKET FRENCH DOUBLE 2P+E 16A 250V~

- 2P+E French double
- 16A 250V~, type VE46
- in accordance with IEC 60884-1, CEE7; NF C 61-314, ČSN 33 2318; PN-E 93201
- screw contacts 1,5-2,5 mm<sup>2</sup>
- shuttered live contacts



PRIZË 2P 16 A 250 V~



- VE30PW
- VE30IW
- VE30ES
- VE30NB

- 2P pa kontakt për tokëzimin
- 16 A 250 V~
- në përputhje me EN 60884-1, CEE7 (fleta e standardit I)
- kontaktet e vidave 1,5-2,5 mm<sup>2</sup>

SOCKET 2P 16A 250V~

- 2P without earthing contact
- 16A 250V~
- in accordance with EN 60884-1, CEE7 (standard sheet I)
- screw contacts 1.5-2.5mm<sup>2</sup>

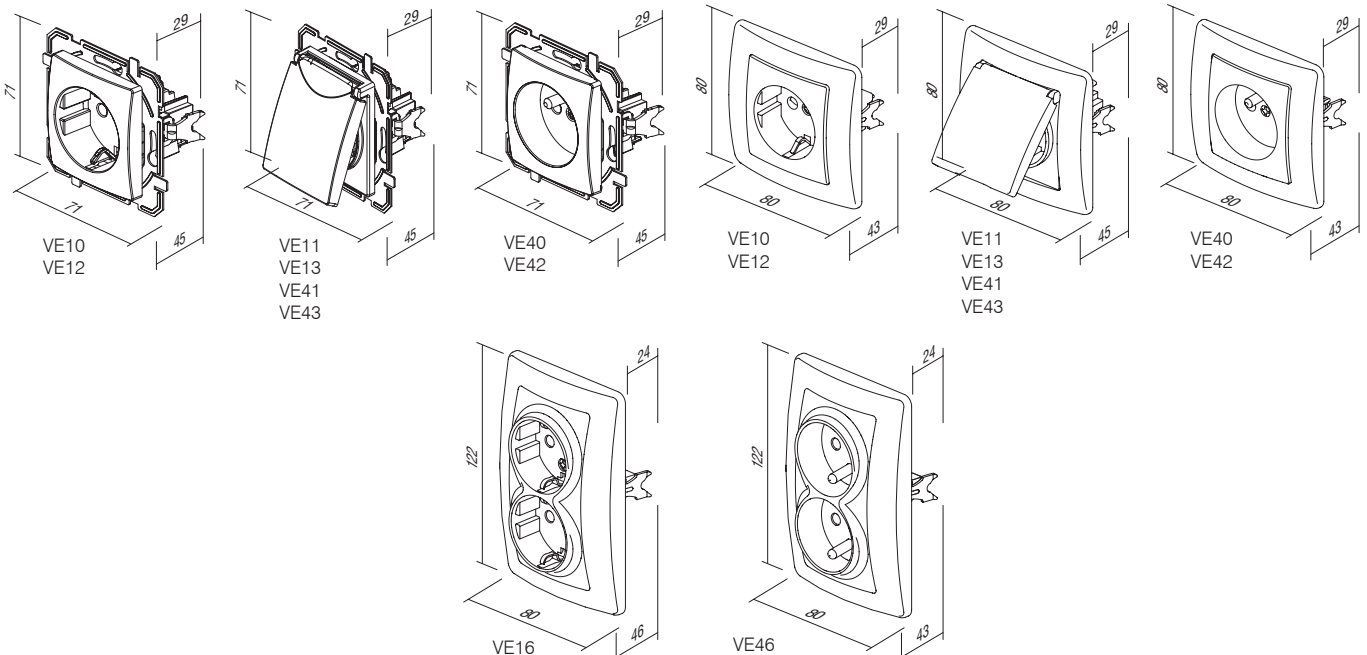



KE37

PW

Iloji type	përshkrimi description	të dhënat teknike technical data	ngjyra colour
KE11	PRIZË TV-R ME KAPAK FUNDOR SOCKET TV-R END-LINE	1dB	<input type="checkbox"/> PW e bardhë polare polar white
KE12	PRIZË TV-R KALUESE SOCKET TV-R THROUGHPASS	10dB	<input type="checkbox"/> IW e bardhë fildishi ivory white
KE16	PRIZË SAT-TV-R ME KAPAK FUNDOR SOCKET SAT-TV-R END-LINE	3dB	<input type="checkbox"/> ES e argjendtë elox elox silver
⋮	⋮	⋮	<input type="checkbox"/> CO termoset i bardhë white thermoset
⋮	⋮	⋮	<input type="checkbox"/> NB e zezë mesnate night black

## PRIZË TV-R ME KAPAK FUNDOR 1dB



KE11

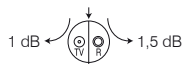

- TV-R me kapak fundor
- gama e frekuencës 5-862MHz
- reduktimi: R-1.5dB, TV-1dB
- në përputhje me EN 50083-1
- kontaktet e vidave

## SOCKET TV-R END-LINE 1dB

- TV-R end-line
- frequency range 5-862MHz
- reduction: R-1.5dB, TV-1dB
- in accordance with EN 50083-1
- screw contacts

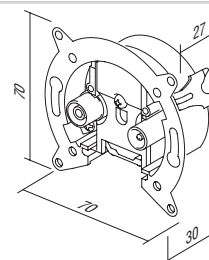

## PRIZË TV-R KALUESE 10dB



KE12

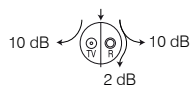

- TV-R kaluese
- gama e frekuencës 5-862MHz
- reduktimi: R-10dB, TV-10dB, kaluese-2dB
- në përputhje me EN 50083-1
- kontaktet e vidave

## SOCKET TV-R THROUGHPASS 10dB

- TV-R throughpass
- frequency range 5-862MHz
- reduction: R-10dB, TV-10dB, through-2dB
- in accordance with EN 50083-1
- screw contacts

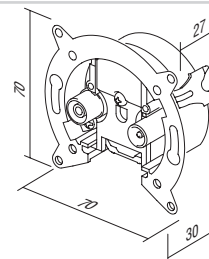

## PRIZË SAT-TV-R ME KAPAK FUNDOR 3dB



KE16

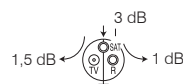

- SAT-TV-R me kapak fundor
- gama e frekuencës 5-2400MHz
- reduktimi: R-1dB, TV-1.5dB, SAT-3dB
- për montim në kuti të rumbullakët Ø60 me kthetra ose vida
- në përputhje me EN 50083-1
- kontaktet e vidave

## SOCKET SAT-TV-R END-LINE 3dB

- SAT-TV-R end-line
- frequency range 5-2400MHz
- reduction: R-1dB, TV-1.5dB, SAT-3dB
- for mounting in round box Ø60 with claws or screws
- in accordance with EN 50083-1
- screw contacts

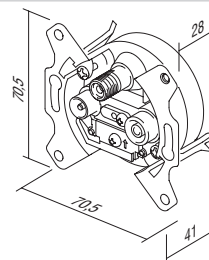

## PRIZË TEL KS RJ11 6/4

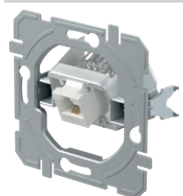

KE36

- standard fiksues trapez KS
- RJ11 6/4
- në përputhje me IEC 60603-7

## SOCKET TEL KS RJ11 6/4

- KS keystone fixing standard
- RJ11 6/4
- in accordance with IEC 60603-7

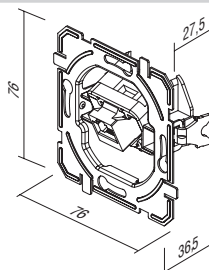

	KE37	<b>PRIZË CAT5e KS RJ45 8/8</b> - standard fiksues trapez KS - CAT5e, RJ45 8/8 - në përputhje me IEC 60603-7  <i>SOCKET CAT5e KS RJ45 8/8</i> - KS keystone fixing standard - CAT5e, RJ45 8/8 - in accordance with IEC 60603-7	
	KE40	<b>PRIZË CAT6s KS RJ45 8/8 SLIM</b> - standard fiksues trapez KS - CAT6s, RJ45 8/8 - në përputhje me IEC 60603-7  <i>SOCKET CAT6s KS RJ45 8/8 SLIM</i> - KS keystone fixing standard - CAT6s, RJ45 8/8 - in accordance with IEC 60603-7	
	KE38	<b>PRIZË TEL KS DYSHE 2x RJ11 6/4</b> - standard fiksues trapez KS - 2x RJ11 6/4 - në përputhje me IEC 60603-7  <i>SOCKET TEL KS DOUBLE 2x RJ11 6/4</i> - KS keystone fixing standard - 2x RJ11 6/4 - in accordance with IEC 60603-7	
	KE39	<b>PRIZË CAT5e KS DYSHE 2x RJ45 8/8</b> - standard fiksues trapez KS - 2x CAT5e, RJ45 8/8 - në përputhje me IEC 60603-7  <i>SOCKET CAT5e KS DOUBLE 2x RJ45 8/8</i> - KS keystone fixing standard - 2x CAT5e, RJ45 8/8 - in accordance with IEC 60603-7	
	KE41	<b>PRIZË CAT6s KS DYSHE 2x RJ45 8/8 SLIM</b> - standard fiksues trapez KS - 2x CAT6s, RJ45 8/8 - në përputhje me IEC 60603-7  <i>SOCKET CAT6s KS DOUBLE 2x RJ45 8/8 SLIM</i> - KS keystone fixing standard - 2x CAT6s, RJ45 8/8 - in accordance with IEC 60603-7	
	KE45	<b>PËRSHTATËS KS NJËSH</b> - standard fiksues trapez KS - njësh - AMP, Avaya, Brandrex, FMT, Mfico, Tyco, ... - moduli i komunikimit nuk përfshihet  <i>ADAPTER KS SINGLE</i> - KS keystone fixing standard - single - AMP, Avaya, Brandrex, FMT, Mfico, Tyco, ... - communication module not included	

## PËRSHTATËS KS DYSH

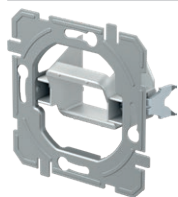

KE46

- standard fiksues trapez KS - dysh
- AMP, Tyco, ...
- moduli i komunikimit nuk përfshihet

*ADAPTER KS DOUBLE*

- KS keystone fixing standard - double
- AMP, Tyco, ...
- communication module not included

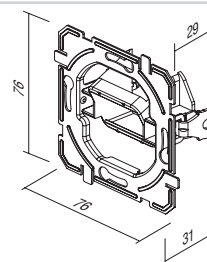

## PËRSHTATËS PD DYSH

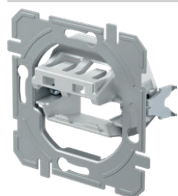

KE47

- standard fiksues PD Panduit Mini-COM - dysh
- moduli i komunikimit nuk përfshihet

*ADAPTER PD DOUBLE*

- PD Panduit Mini-COM fixing standard - double
- communication module not included

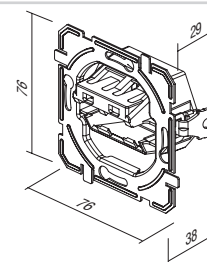



PRIZË TV BAZË 0dB



- KE10PW
- KE10IW
- KE10ES
- KE10CO
- KE10NB

- TV bazë
- reduktim 0dB
- lidhje e pasme – F standarde

SOCKET TV BASIC 0dB

- TV basic
- reduction 0dB
- back connector – F standard



PRIZË TV-R ME KAPAK FUNDOR 1dB



- KE11PW
- KE11IW
- KE11ES
- KE11CO
- KE11NB

- TV-R me kapak fundor
- gama e frekuencës 5÷862 MHz
- reduktimi: R-1.5dB, TV-1dB
- në përputhje me EN 50083-1
- kontaktet e vidave

SOCKET TV-R END-LINE 1dB

- TV-R end-line
- frequency range 5÷862 MHz
- reduction: R-1.5dB, TV-1dB
- in accordance with EN 50083-1
- screw contact



PRIZË TV-R KALUESE 10dB



- KE12PW
- KE12IW
- KE12ES
- KE12CO
- KE12NB

- TV-R kaluese
- gama e frekuencës 5÷862 MHz
- reduktimi: R-10dB, TV-10dB, kaluese-2dB
- në përputhje me EN 50083-1
- kontaktet e vidave

SOCKET TV-R TROUGHPASS 10dB

- TV-R troughpass
- frequency range 5÷862 MHz
- reduction: R-10dB, TV-10dB, trough-2dB
- in accordance with EN 50083-1
- screw contacts



PRIZË SAT-TV-R ME KAPAK FUNDOR 3dB



- KE16PW
- KE16IW
- KE16ES
- KE16CO
- KE16NB

- SAT-TV-R me kapak fundor
- gama e frekuencës 5÷2400 MHz
- reduktimi: R-1dB, TV-1.5dB, SAT-3dB
- në përputhje me EN 50083-1
- kontaktet e vidave

SOCKET SAT-TV-R END-LINE 3dB

- SAT-TV-R end-line
- frequency range 5÷2400 MHz
- reduction: R-1dB, TV-1.5dB, SAT-3dB
- in accordance with EN 50083-1
- screw contacts



PRIZË AUDIO 2xRCA



- KE22PW
- KE22IW
- KE22ES
- KE22CO
- KE22NB

- audio 2xRCA
- lidhje me saldime e kablllos

SOCKET AUDIO 2xRCA

- audio 2xRCA
- soldering connection of cable



PRIZË AUDIO ALTOPARLANTË



- KE23PW
- KE23IW
- KE23ES
- KE23CO
- KE23NB

- audio 2x Ø4mm
- për të mbajtur telin e altoparlantit, spinë banane Ø4 mm ose maç
- lidhje me ngjitje e kablllos në pjesën e pasme

SOCKET AUDIO LOUDSPEAKERS

- audio 2x Ø4mm
- to accommodate speaker wire, banana plug Ø4mm or spades
- soldering connection of cable at the back side



PRIZË TEL KS RJ11 6/4

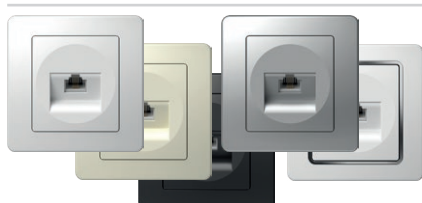

- KE36PW
- KE36IW
- KE36ES
- KE36CO
- KE36NB

- standard fiksues trapez KS
- RJ11 6/4
- në përputhje me IEC 60603-7

SOCKET TEL KS RJ11 6/4

- KS keystone fixing standard
- RJ11 6/4
- in accordance with IEC 60603-7





- KE37PW
- KE37IW
- KE37ES
- KE37CO
- KE37NB

**PRIZË CAT5e KS RJ45 8/8**

- standard fiksues trapez KS
- CAT5e, RJ45 8/8
- në përputhje me IEC 60603-7

*SOCKET CAT5e KS RJ45 8/8*

- KS keystone fixing standard
- CAT5e, RJ45 8/8
- in accordance with IEC 60603-7



- KE40PW
- KE40IW
- KE40ES
- KE40CO
- KE40NB

**PRIZË CAT6s KS RJ45 8/8 SLIM**

- standard fiksues trapez KS
- CAT6s, RJ45 8/8
- në përputhje me IEC 60603-7

*SOCKET CAT6s KS RJ45 8/8 SLIM*

- KS keystone fixing standard
- CAT6s, RJ45 8/8
- in accordance with IEC 60603-7



- KE38PW
- KE38IW
- KE38ES
- KE38CO
- KE38NB

**PRIZË TEL KS DYSHE 2x RJ11 6/4**

- standard fiksues trapez KS
- 2x RJ11, 6/4
- në përputhje me IEC 60603-7

*SOCKET TEL KS DOUBLE 2x RJ11 6/4*

- KS keystone fixing standard
- 2x RJ11, 6/4
- in accordance with IEC 60603-7



- KE39PW
- KE39IW
- KE39ES
- KE39CO
- KE39NB

**PRIZË CAT5e KS DYSHE 2x RJ45 8/8**

- standard fiksues trapez KS
- 2x CAT5e, RJ45 8/8
- në përputhje me IEC 60603-7

*SOCKET CAT5e KS DOUBLE 2x RJ45 8/8*

- KS keystone fixing standard
- 2x CAT5e, RJ45 8/8
- in accordance with IEC 60603-7



- KE41PW
- KE41IW
- KE41ES
- KE41CO
- KE41NB

**PRIZË CAT6s KS DYSHE 2x RJ45 8/8 SLIM**

- standard fiksues trapez KS
- 2x CAT6s, RJ45 8/8
- në përputhje me IEC 60603-7

*SOCKET CAT6s KS DOUBLE 2x RJ45 8/8 SLIM*

- KS keystone fixing standard
- 2x CAT6s, RJ45 8/8
- in accordance with IEC 60603-7

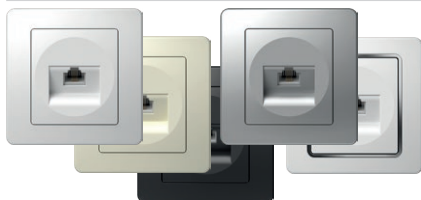

- KE35PW
- KE35IW
- KE35ES
- KE35CO
- KE35NB

**PRIZË TEL LT RJ11 6/4**

- vidë TEL LT
- kontaktet e vidave
- RJ11 6/4
- në përputhje me IEC 60603-7

*SOCKET TEL LT RJ11 6/4*

- TEL LT screw
- screw contacts
- RJ11 6/4
- in accordance with IEC 60603-7

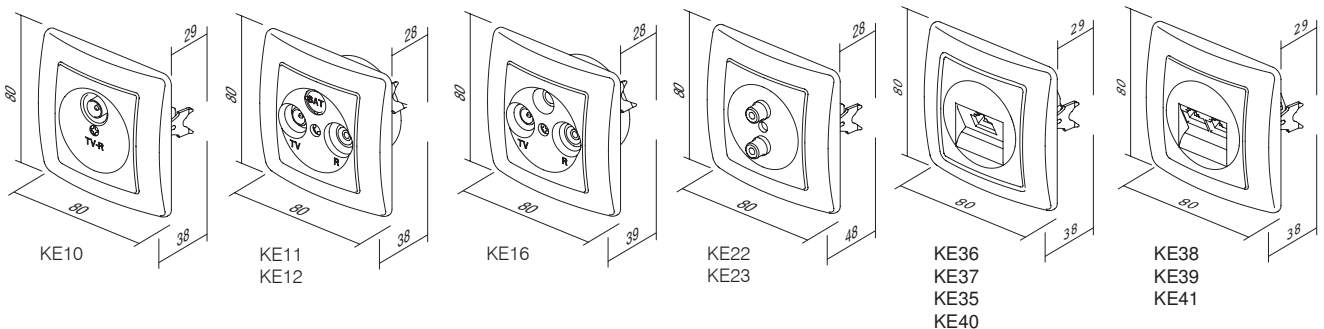

# K A P A K P Ë R K O M U N I K I M E T K E

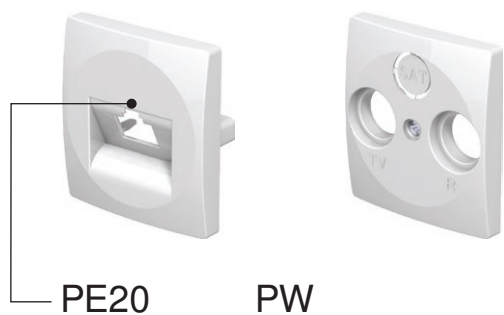

lloji type	përshkrimi description	të dhënat teknike technical data	ngjyra colour
PE10	KAPAK TV-R COVER TV-R	2P/3P	<input type="checkbox"/> PW e bardhë polare polar white
PE20	KAPAK KS NJËSH COVER KS SINGLE		<input type="checkbox"/> IW e bardhë fildishi ivory white
PE21	KAPAK KS DYSH COVER KS DOUBLE		<input type="checkbox"/> ES e argjendtë elox elox silver
⋮	⋮	⋮	<input type="checkbox"/> CO termoset i bardhë white thermoset
			<input type="checkbox"/> NB e zezë mesnate night black

## KAPAK TV-R 2P/3P

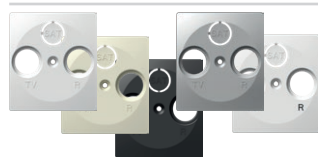

- PE10PW
- PE10IW
- PE10ES
- PE10CO
- PE10NB

- kapak TV-R, 2P ose 3P me vidë

*COVER TV-R 2P/3P*

- TV-R cover, 2P or 3P with screw



## KAPAK KS NJËSH

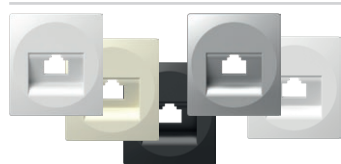

- PE20PW
- PE20IW
- PE20ES
- PE20CO
- PE20NB

- kapak KS njësh

*COVER KS SINGLE*

- KS cover single



## KAPAK KS DYSH

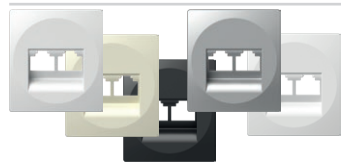

- PE21PW
- PE21IW
- PE21ES
- PE21NB

- kapak KS dysh

*COVER KS DOUBLE*

- KS cover double



## KAPAK TAE/TDO



- PE30PW
- PE30IW
- PE30ES
- PE30NB

- kapak TAE ose TDO me vidë

*COVER TAE/TDO*

- TAE or TDO cover with screw

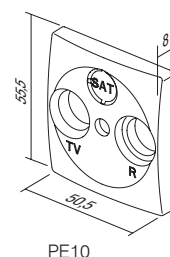
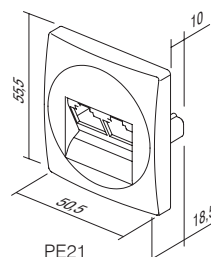
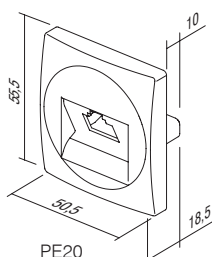
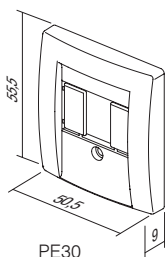



EE15

PW

lloji type	përshkrimi description	të dhënat teknike technical data	ngjyra colour
EE15	REOSTAT RROTULLUES ME 2 DREJTIME DIMMER ROTATIVE 2WAY	RL 400W	<input type="checkbox"/> PW e bardhë polare polar white
EE16	REOSTAT RROTULLUES ME 2 DREJTIME DIMMER ROTATIVE 2WAY	RLC 400W	<input type="checkbox"/> IW e bardhë fildishi ivory white
EE19	REOSTAT RROTULLUES ME 2 DREJTIME DIMMER ROTATIVE 2WAY	LED 100W	<input type="checkbox"/> ES e argjendtë elox elox silver
⋮	⋮	⋮	<input type="checkbox"/> CO termoset i bardhë white thermoset
⋮	⋮	⋮	<input type="checkbox"/> NB e zezë mesnate night black

## REOSTAT RROTULLUES ME 2 DREJTIME RL 400 W



EE15



- kontroll i rrotullimit me çelësin me 2 drejtime
- RL i ngarkesës, 40 W - 400W
- është i mundur kombinimi i çelësit me 2 drejtime
- nuk lejohet kombinim i më shumë reostateve
- në përputhje me standardet EN 60669-1 dhe EN 60669-2-1
- kontakte për futje telash 1,5 mm<sup>2</sup>
- tensioni i furnizimit, 230 V ~ 50 Hz
- diametri i brendshëm i butonit Ø6 mm
- përfshihet siguresa e zëvendësueshme

## DIMMER ROTATIVE 2WAY RL 400W

- rotation control with 2-way switch
- load RL, 40W - 400W
- 2-way switch combination is possible
- more dimmers combination is not allowed
- in accordance with EN 60669-1 and EN 60669-2-1
- plug-in contacts 1.5mm<sup>2</sup>
- supply 230V~ 50Hz
- button inner diameter Ø6mm
- replaceable fuse included

## REOSTAT RROTULLUES ME 2 DREJTIME RLC 400 W

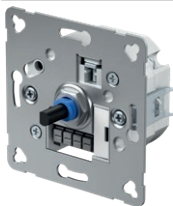

EE16



- kontroll i rrotullimit me çelësin me 2 drejtime
- RLC i ngarkesës, 20W - 400W
- është i mundur kombinimi i çelësit me 2 drejtime
- nuk lejohet kombinim i më shumë reostateve
- në përputhje me standardet EN 60669-1 dhe EN 60669-2-1
- kontakte për futje telash 1,5 mm<sup>2</sup>
- tensioni i furnizimit, 230 V ~ 50 Hz
- diametri i brendshëm i butonit Ø6 mm
- siguresë elektronike

## DIMMER ROTATIVE 2WAY RLC 400W

- rotation control with 2-way switch
- load RLC, 20W - 400W
- 2-way switch combination is possible
- more dimmers combination is not allowed
- in accordance with EN 60669-1 and EN 60669-2-1
- plug-in contacts 1.5mm<sup>2</sup>
- supply 230V~ 50Hz
- button inner diameter Ø6mm
- electronic fuse



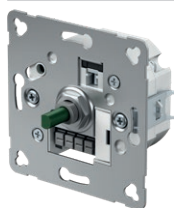

EE19



## REOSTAT RROTULLUES ME 2 DREJTIME LED 100W

- kontroll i rrotullimit me çelësin me 2 drejtime
- ngarkesa: LED, 0-100 W (maks. 10 LED-e)  
GLS, 10-250 W
- është i mundur kombinimi i çelësit me 2 drejtime
- nuk lejohet kombinim i më shumë reostateve
- në përputhje me standardet EN 60669-1 dhe EN 60669-2-1
- kontakte për futje telash 1,5 mm<sup>2</sup>
- tensioni i furnizimit, 230 V ~ 50 Hz
- përfshihet siguresa e zëvendësueshme
- diametri i brendshëm i butonit Ø6 mm

## DIMMER ROTATIVE 2WAY LED 100W

- rotation control with 2-way switch
- load: LED, 0-100W (max. 10 LEDs)  
GLS, 10-250W
- 2-way switch combination is possible
- more dimmers combination is not allowed
- in accordance with EN 60669-1 and EN 60669-2-1
- plug-in contacts 1.5mm<sup>2</sup>
- supply 230V~ 50Hz
- replaceable fuse included
- button inner diameter Ø6mm

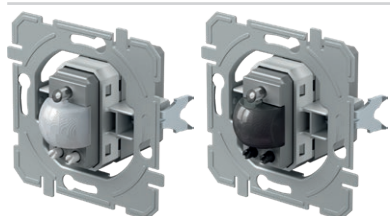

- EE32A1
- EE32A2



## ÇELËS IR 5A X 250V~

- çelës IR me infra të kuqe
- furnizimi me energji: 230 V~ ±10 % 50 Hz
- rele: 5 A / 250 V~ (zero kryqëzim)
- vlerësimi i mbrojtjes: IP40
- prerja e tërthortë e telave në kontakt 0,75 - 2,5 mm<sup>2</sup>
- zona e zbulimit: deri në 110° në 20°C
- zona e zbulimit: rreth 8 m në 20°C
- rregullimi i kohëzgjatjes: nga rreth 5 sek. në 12 min.
- rregullimi i ndriçimit: nga rreth 5 deri 200 LUX
- temperatura e funksionimit: nga 0°C në +40°C
- i papërshtatshëm për instalim në kuti me thellësi 45 mm
- vetëm për përdorim të brendshëm

## IR SWITCH 5A 230V~

- IR infrared switch
- supply voltage: 230V~ ±10 % 50Hz
- relay: 5A / 250V~ (zero crossing)
- protection rating: IP40
- cross-section of wires at the contact terminal: 0.75 - 2.5 mm<sup>2</sup>
- detection angle: up to 110° at 20°C
- detection area: approx. 8 m at 20°C
- adjustability of duration: from approx. 5 s to 12 min
- adjustability of brightness: from approx. 5 to 200 LUX
- operating temperature: from 0°C to +40°C
- not suitable for installation in 45 mm deep boxes
- only for indoor usage

 EE67

## NJËSIA E FURNIZIMIT ME ENERGJI USB 5 V 2,4 A

- për karikimin e pajisjeve elektronike përmes një porte standarde USB (e përputhshme gjithashtu edhe me pajisjet Apple)
- furnizimi me energji: 100-230 V ~ 50/60 Hz
- konsumi i energjisë: 300 mA në 100 V~/150 mA në 230 V~
- konsumi i energjisë në gatishmëri: 30mW në 230 V~
- tensioni nominal në dalje: 5 VCD (±5 %) SELV
- tensioni i ondulacionit në dalje: 150 mV
- rryma nominale në dalje: 2,4 A (±10%)
- lloji i konektorit: USB A / USB A
- efikasiteti: maksimumi 77%
- temperatura e funksionimit: 0°C/+45°C (përdorimi i brendshëm)
- klasi i mbrojtjes IP: IP20, vetëm për përdorim në ambiente të brendshme
- klasi i pajisjes II
- kategoria e mbtensionit (EN 62109): Klasi III
- kontaktet e vidave maks. 2,5 mm<sup>2</sup>
- pajisje me hapësirë kontakti prej të paktën 3 mm
- në përputhje me standardet EN 60950-1 dhe Direktivës LVC dhe EMC

## USB POWER SUPPLY UNIT 5V 2.4A

- for charging electronic devices via a standard USB port (also compatible with Apple devices)
- power supply: 100-230V~ 50/60Hz
- power consumption: 300mA at 100V~/150mA at 230V~
- standby power consumption: 30mW at 230V~
- nominal output voltage: 5 VCD (± 5%) SELV
- output ripple voltage: 150mV
- nominal output current: 2.4A (±10%)
- connector type: USB A / USB A
- efficiency: maximum of 77%
- operating temperature: 0°C/+45°C (indoor use)
- IP protection class: IP20, indoor use only
- class device II
- overvoltage category (EN 62109): Class III
- screw contacts: max. 2.5 mm<sup>2</sup>
- device with a contact gap of at least 3mm
- in accordance with the EN 60950-1 and LVD & EMC directives

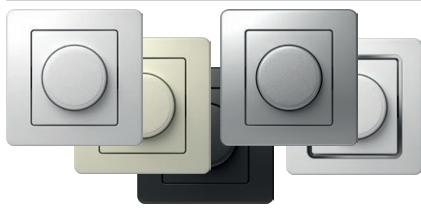

- EE15PW
- EE15IW
- EE15ES
- EE15CO
- EE15NB



#### REOSTAT RROTULLUES ME 2 DREJTIME RL 400 W

- kontroll i rrotullimit me çelësin me 2 drejtime
- RL i ngarkesës, 40 W - 400W
- është i mundur kombinimi i çelësit me 2 drejtime
- nuk lejohet kombinimi i më shumë reostateve
- në përputhje me standardet EN 60669-1 dhe EN 60669-2-1
- kontakte për futje telash 1,5 mm<sup>2</sup>
- tensioni i furnizimit, 230 V ~ 50 Hz
- përfshihet siguresa e zëvendësueshme



#### DIMMER ROTATIVE 2WAY RL 400W

- rotation control with 2-way switch
- load RL, 40W - 400W
- 2-way switch combination is possible
- more dimmers combination is not allowed
- in accordance with EN 60669-1 and EN 60669-2-1
- plug-in contacts 1.5mm<sup>2</sup>
- supply 230V~ 50Hz
- replaceable fuse included

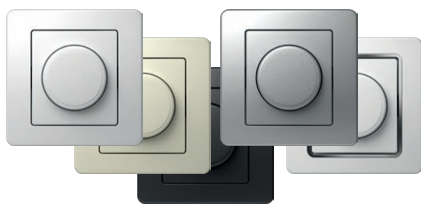

- EE16PW
- EE16IW
- EE16ES
- EE16CO
- EE16NB



#### REOSTAT RROTULLUES ME 2 DREJTIME RLC 400 W

- kontroll i rrotullimit me çelësin me 2 drejtime
- RLC i ngarkesës, 20W - 400W
- është i mundur kombinimi i çelësit me 2 drejtime
- nuk lejohet kombinimi i më shumë reostateve
- në përputhje me standardet EN 60669-1 dhe EN 60669-2-1
- kontakte për futje telash 1,5 mm<sup>2</sup>
- tensioni i furnizimit, 230 V ~ 50 Hz
- siguresë elektronike



#### DIMMER ROTATIVE 2WAY RLC 400W

- rotation control with 2-way switch
- load RLC, 20W - 400W
- 2-way switch combination is possible
- more dimmers combination is not allowed
- in accordance with EN 60669-1 and EN 60669-2-1
- plug-in contacts 1.5mm<sup>2</sup>
- supply 230V~ 50Hz
- electronic fuse



- EE19PW
- EE19IW
- EE19ES
- EE19CO
- EE19NB



#### REOSTAT RROTULLUES ME 2 DREJTIME LED 100W

- kontroll i rrotullimit me çelësin me 2 drejtime
- ngarkesa: LED, 0-100 W (maks. 10 LED-e)  
GLS, 10-250 W
- është i mundur kombinimi i çelësit me 2 drejtime
- nuk lejohet kombinimi i më shumë reostateve
- në përputhje me standardet EN 60669-1 dhe EN 60669-2-1
- kontakte për futje telash 1,5 mm<sup>2</sup>
- tensioni i furnizimit, 230 V ~ 50 Hz
- përfshihet siguresa e zëvendësueshme



#### DIMMER ROTATIVE 2WAY LED 100W

- rotation control with 2-way switch
- load: LED, 0-100W (max. 10 LEDs)  
GLS, 10-250W
- 2-way switch combination is possible
- more dimmers combination is not allowed
- in accordance with EN 60669-1 and EN 60669-2-1
- plug-in contacts 1.5mm<sup>2</sup>
- supply 230V~ 50Hz
- replaceable fuse included



- EE32PW
- EE32IW
- EE32ES
- EE32CO
- EE32NB



#### ÇELËS IR 5A X 230V~

- çelës IR me infra të kuqe
- furnizimi me energji: 230 V~ ±10 % 50 Hz
- rele: 5 A / 250 V~ (zero kryqëzim)
- vlerësimi i mbrojtjes: IP40
- prejra e tërthorët e telave në kontakt 0,75 - 2,5 mm<sup>2</sup>
- zona e zbulimit: deri në 110° në 20°C
- zona e zbulimit: rreth 8 m në 20°C
- rregullimi i kohëzgjatjes: nga rreth 5 sek. në 12 min.
- rregullimi i ndriçimit: nga rreth 5 deri 200 LUX
- temperatura e funksionimit: nga 0°C në +40°C
- i papërshtatshëm për instalim në kuti me thellësi 45 mm
- vetëm për përdorim të brendshëm



#### IR SWITCH 5A 230V~

- IR infrared switch
- supply voltage: 230V~ ±10 % 50Hz
- relay: 5A / 250V~ (zero crossing)
- protection rating: IP40
- cross-section of wires at the contact terminal: 0.75 - 2.5 mm<sup>2</sup>
- detection angle: up to 110° at 20°C
- detection area: approx. 8 m at 20°C
- adjustability of duration: from approx. 5 s to 12 min
- adjustability of brightness: from approx. 5 to 200 LUX
- operating temperature: from 0°C to +40°C
- not suitable for installation in 45 mm deep boxes
- only for indoor usage



- EE67PW
- EE67IW
- EE67NB
- EE67ES

#### NJËSIA E FURNIZIMIT ME ENERGJI USB 5 V 2,4 A

- për karikimin e pajisjeve elektronike përmes një porte standarde USB (e përputhshme gjithashtu edhe me pajisjet Apple)
- furnizimi me energji: 100-230 V ~ 50/60 Hz
- konsumi i energjisë: 300 mA në 100 V~/150 mA në 230 V~
- konsumi i energjisë në gatihsmëri: 30mW në 230 V~
- tensioni nominal në dalje: 5 VCD (±5 %) SELV
- tensioni i ondulacionit në dalje: 150 mV
- rryma nominale në dalje: 2,4 A (±10%)
- lloji i konektorit: USB A / USB A
- efikasiteti: maksimumi 77%
- temperatura e funksionimit: 0°C/+45°C (përdorimi i brendshëm)
- klasi i mbrojtjes IP: IP20, vetëm për përdorim në ambiente të brendshme
- klasi i pajisjes II
- kategoria e mbritensionit (EN 62109): Klasi III
- kontaktet e vidave maks. 2,5 mm<sup>2</sup>
- pajisje me hapësirë kontakti prej të paktën 3 mm
- në përputhje me standardet EN 60950-1 dhe Direktivës LVC dhe EMC



#### USB POWER SUPPLY UNIT 5V 2.4A

- for charging electronic devices via a standard USB port (also compatible with Apple devices)
- power supply: 100-230V~ 50/60Hz
- power consumption: 300mA at 100V~/150mA at 230V~
- standby power consumption: 30mW at 230V~
- nominal output voltage: 5 VCD (± 5%) SELV
- output ripple voltage: 150mV
- nominal output current: 2.4A (±10%)
- connector type: USB A / USB A
- efficiency: maximum of 77%
- operating temperature: 0°C/+45°C (indoor use)
- IP protection class: IP20, indoor use only
- class device II
- overvoltage category (EN 62109): Class III
- screw contacts: max. 2.5 mm<sup>2</sup>
- device with a contact gap of at least 3mm
- in accordance with the EN 60950-1 and LVD & EMC directives



- EE68PW
- EE68IW
- EE68NB
- EE68ES

#### NJËSIA E FURNIZIMIT ME ENERGJI USB 5 V 2,4 A

- Furnizimi 100 – 230 V ~ 50/60 Hz
- Konsumi: 300 mA në 100V~/ / 150 mA në 230 V~
- Konsumi në gjendje gatihsmërie: 30 mW në 230 V~
- Tensioni nominal dalës: 5 ~ (±5%) SELV
- Valëzimi (ripple) i tensionit dalës: 150 mV
- Fuqia nominale dalëse:
  - EM68, EQ68, EE68: 3,0 A (±10 %) ; (lloji USB A / USB C)
- Efikasiteti: maks. 77%
- Temperatura e punës: 0°C/+45°C (përdorimi i brendshëm)
- Kategoria e mbrojtjes IP: IP20, vetëm për përdorim të brendshëm
- Kategoria e sigurisë së pajisjes II
- Kategoria e mbritensionit (EN 62109): kategoria III
- Fiksimi me vidë i përcjellësit me diametër 2,5 mm<sup>2</sup>
- Pajisje me distancë kontakti prej së paku 3 mm



#### USB POWER SUPPLY UNIT 5V 3.0A

- power supply: 100-230V~ 50/60Hz
- power consumption: 300mA at 100V~/150mA at 230V~
- standby power consumption: 30mW at 230V~
- nominal output voltage: 5 ~ (±5%) SELV
- output ripple voltage: 150mV
- nominal output current:
  - EM68 , EQ68, EE68: 3,0 A (±10 %) ; (Type USB A / USB C)
- efficiency: maximum of 77%
- operating temperature: 0°C/+45°C (indoor use)
- IP protection class: IP20, indoor use only
- class device II
- overvoltage category (IEC 60364-4-44) CAT II  
a low-voltage SPD (surge protective devices) in accordance with the EN 61643-11 intended to reduce the overvoltage category III to II must be installed upstream of the USB device
- screw contacts: max. 2.5 mm<sup>2</sup>
- device with a contact gap of at least 3mm

EE15, EE16, EE19

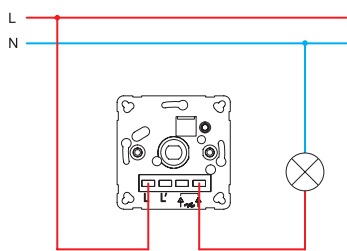

EE15, EE16, EE19

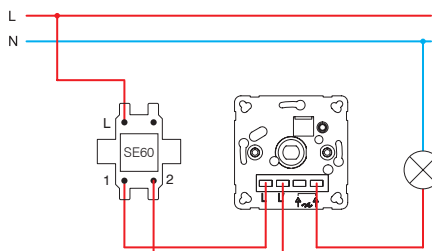

EE15, EE16, EE19

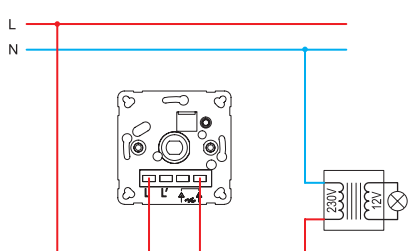

EE15, EE16, EE19

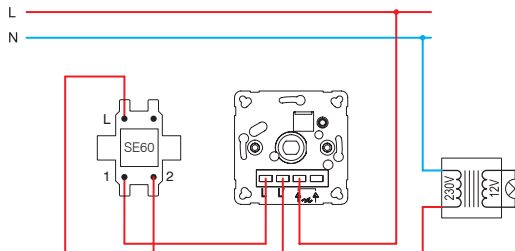

EE16, EE19

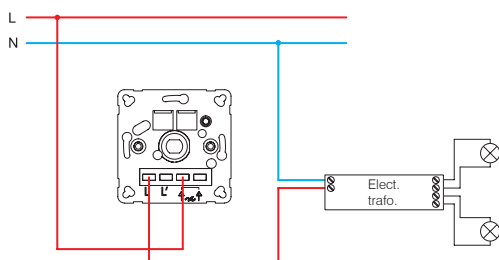

EE16, EE19

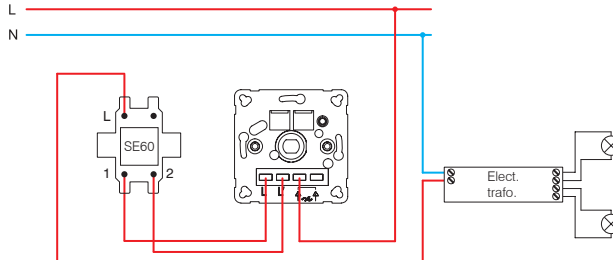

EE15 (40÷400W)

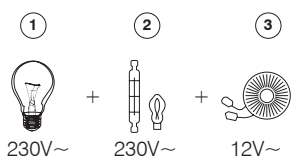

- 1 - llambë inkandeshente / incandescent lamp
- 2 - llambë halogjene / halogen lamp

EE16 (20÷400W)

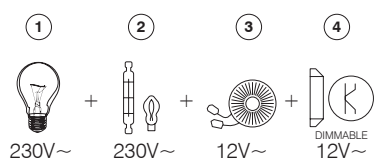

- 3 - transformator klasik / classical transformer
- 4 - transformator elektrik me dimer / dimmable electronic transformer

EE19 (GLS 10÷250W ; LED 0÷100W)

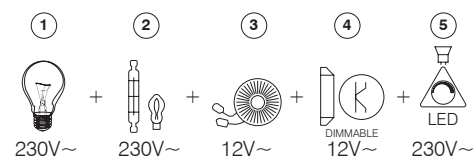

- 5 - llambë LED me ulje ndriçimi / dimmable LED lamp

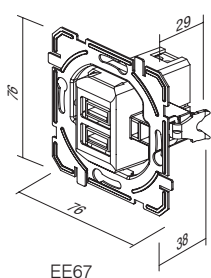

EE67

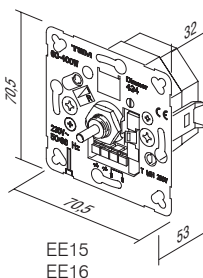

EE15  
EE16  
EE19

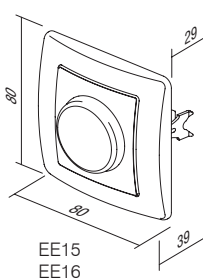

EE15  
EE16  
EE19

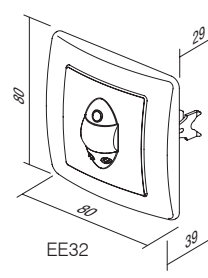

EE32



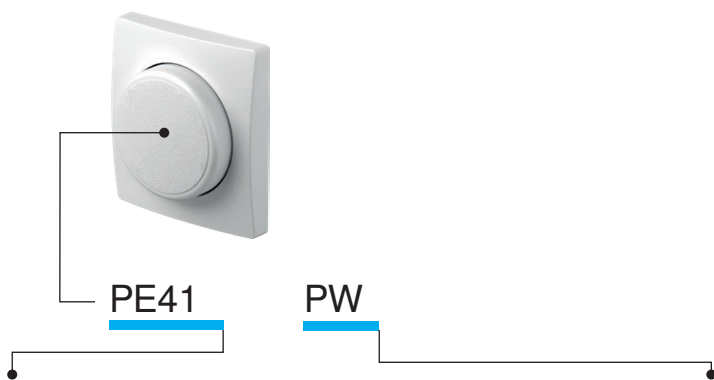

lloji type	përshkrimi description	ngjyra colour
PE41	REOSTAT ME KAPAK COVER DIMMER	<input type="checkbox"/> PW e bardhë polare polar white  <input type="checkbox"/> IW e bardhë fildishi ivory white  <input type="checkbox"/> ES e argjendtë elox elox silver  <input type="checkbox"/> CO termoset i bardhë white thermoset  <input type="checkbox"/> NB e zezë mesnate night black

#### REOSTAT ME KAPAK Ø6



- PE41PW
- PE41IW
- PE41NB
- PE41ES
- PE41CO

- reostat me kapak Ø6 mm  
- me EE15, EE16, EE19  
**COVER DIMMER Ø6**  
- cover dimmer Ø6mm  
- for EE15, EE16, EE19



#### KAPAK ÇELËS IR



- PE32PW
- PE32IW
- PE32NB
- PE32ES

- kapak çelës IR  
**COVER IR SWITCH**  
- cover IR switch



#### NJËSIA E FURNIZIMIT ME USB ME KAPAK



- PE67PW
- PE67IW
- PE67NB
- PE67ES

- Kapaku i njësisë së furnizimit me USB  
**USB SUPPLY UNIT COVER**  
- USB supply unit cover

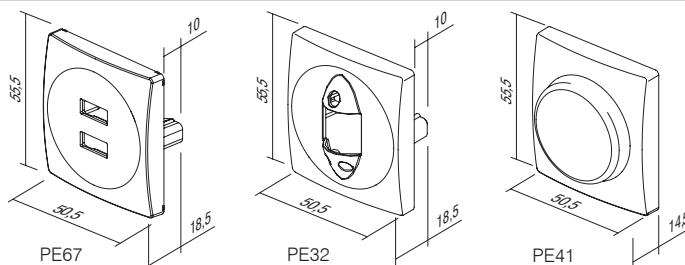

## A C C E S S O R I E S    A E

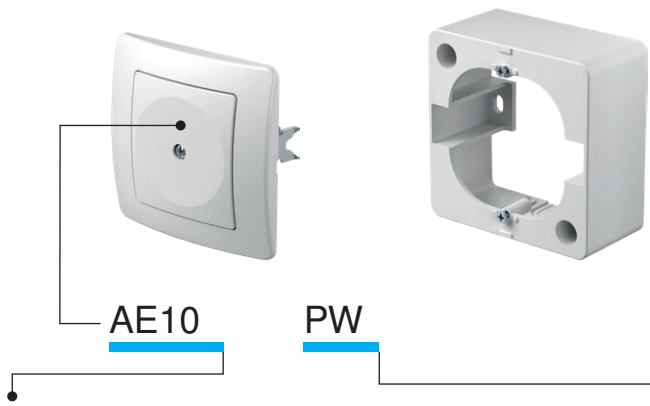

Iloji type	përshkrimi description	ngjyra colour
AE10	FALSO BLANK	<input type="checkbox"/> PW e bardhë polare polar white
AE20	KUTI LIDHJEJE 3P+N+E 5X4 mm <sup>2</sup> CONNECTION BOX 3P+N+E 5X4mm <sup>2</sup>	<input type="checkbox"/> IW e bardhë fildishi ivory white
AE30	KUTI ME MONTIM NË SIPËRFAQE NO 1 SURFACE MOUNT BOX	<input type="checkbox"/> ES e argjendtë elox elox silver
⋮	⋮	<input type="checkbox"/> CO termoset i bardhë white thermoset
⋮	⋮	<input type="checkbox"/> NB e zezë mesnate night black

**FALSO**

- AE10PW
- AE10IW
- AE10NB
- AE10ES
- AE10CO

- për mbushjen e hapësirave boshe  
**BLANK**  
- for filling up empty spaces

**KUTI LIDHJEJE 5 POLARE 3P+N+E 5X4 mm<sup>2</sup>**

- AE20PW
- AE20IW

- kuti lidhjeje 3P+N+E  
- 16 A 400V~  
- në përputhje me VDE 0606-1:2000  
- kontaktet e vidave 1,5-4mm<sup>2</sup>  
**CONNECTION BOX 5POLE 3P+N+E 5x4mm<sup>2</sup>**  
- 3P+N+E connection box  
- 16A 400V~  
- in accordance with VDE 0606-1:2000  
- screw contacts 1.5-4mm<sup>2</sup>

**KUTI ME MONTIM NË SIPËRFAQE 1**

- AE30PW
- AE30IW

- kuti me montim në sipërfaqe  
**SURFACE MOUNT BOX 1**  
- surface mounting box

**KUTI SIPËRFAQËSORE PËR PRIZË DYSHE EKONOMIK**

- AE31PW

- kuti me montim në sipërfaqe  
**SURFACE MOUNT BOX FOR EKONOMIK DOUBLE SOCKET**  
- surface mounting box

MBROJTJE PËR MUR



- AE50PW
- AE50TS

- mbron sipërfaqen rrotull prizës ose çelësit

*WALL PROTECTION*

- protects surface around socket or switch

MBROJTJE PËR FËMIJËT KS



- AE51PW
- AE51IW

- insert shtesë KS për mbrojtje për fëmijët

*CHILD PROTECTION KS*

- KS additional child protection insert - shuttered live contacts

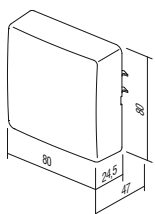

AE20

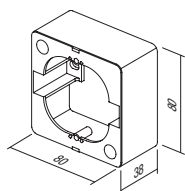

AE30

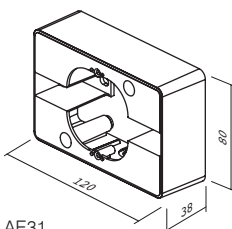

AE31

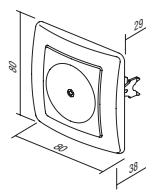

AE10

## S U R R O U N D S O E

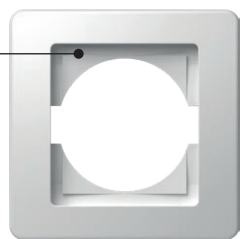

OE10



PW

Iloji type	përshkrimi description	ngjyra colour
OE10	RRETHUES EKONOMIK 1 SURROUND EKONOMIK 1	<input type="checkbox"/> PW e bardhë polare polar white
OE20	RRETHUES EKONOMIK 2 HORIZONTAL SURROUND EKONOMIK 2 HORIZONTAL	<input type="checkbox"/> IW e bardhë fildishi ivory white
OE30	RRETHUES EKONOMIK 3 HORIZONTAL SURROUND EKONOMIK 3 HORIZONTAL	<input type="checkbox"/> ES e argjendtë elox elox silver
⋮	⋮	<input type="checkbox"/> CO termoset i bardhë white thermoset
⋮	⋮	<input type="checkbox"/> NB e zezë mesnate night black

## RRETHUES EKONOMIK 1



- OE10PW
- OE10IW
- OE10ES
- OE10CO
- OE10NB

- rrethues dekorativ me 1 pozicion  
- në përputhje me EN 60669-1

**SURROUND EKONOMIK 1**  
- decorative surround 1-gang  
- in accordance with EN 60669-1

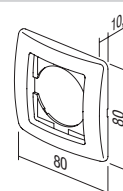

## RRETHUES EKONOMIK 2 HORIZONTAL



- OE20PW
- OE20IW
- OE20ES
- OE20CO
- OE20NB

- rrethues dekorativ me 2 pozicione horizontal  
- në përputhje me EN 60669-1

**SURROUND EKONOMIK 2 HORIZONTAL**  
- decorative surround 2-gang horizontal  
- in accordance with EN 60669-1

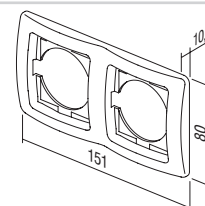

## RRETHUES EKONOMIK 2 VERTIKAL



- OE21PW
- OE21IW
- OE21ES
- OE21CO
- OE21NB

- rrethues dekorativ me 2 pozicione vertikal  
- në përputhje me EN 60669-1

**SURROUND EKONOMIK 2 VERTICAL**  
- decorative surround 2-gang vertical  
- in accordance with EN 60669-1

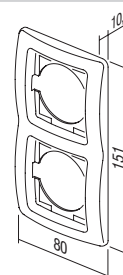

## RRETHUES EKONOMIK 3 HORIZONTAL



- OE30PW
- OE30IW
- OE30ES
- OE30CO
- OE30NB

- rrethues dekorativ me 3 pozicione horizontal  
- në përputhje me EN 60669-1

**SURROUND EKONOMIK 3 HORIZONTAL**  
- decorative surround 3-gang horizontal  
- in accordance with EN 60669-1

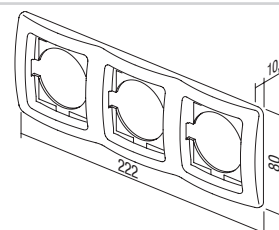





- OE31PW
- OE31IW
- OE31ES
- OE31CO
- OE31NB

**RRETHUES EKONOMIK 3 VERTIKAL**

- rrethues dekorativ me 3 pozicione vertikal  
- në përputhje me EN 60669-1

*SURROUND EKONOMIK 3 VERTIKAL*

- decorative surround 3-gang vertical  
- in accordance with EN 60669-1

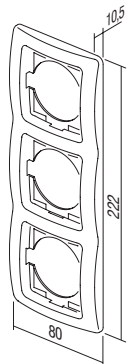

- OE40PW
- OE40IW
- OE40ES
- OE40NB

**RRETHUES EKONOMIK 4 HORIZONTAL**

- rrethues dekorativ me 4 pozicione horizontal  
- në përputhje me EN 60669-1

*SURROUND EKONOMIK 4 HORIZONTAL*

- decorative surround 4-gang horizontal  
- in accordance with EN 60669-1

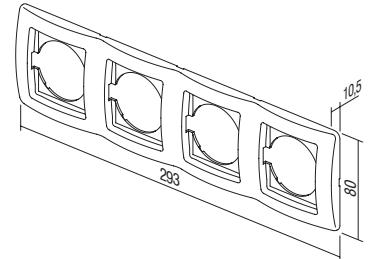

- OE41PW
- OE41IW
- OE41ES
- OE41NB

**RRETHUES EKONOMIK 4 VERTIKAL**

- rrethues dekorativ me 4 pozicione vertikal  
- në përputhje me EN 60669-1

*SURROUND EKONOMIK 4 VERTIKAL*

- decorative surround 4-gang vertical  
- in accordance with EN 60669-1

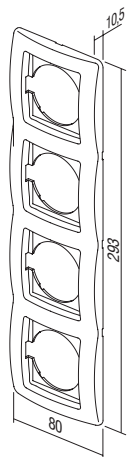

- OE50PW
- OE50IW
- OE50ES
- OE50NB

**RRETHUES EKONOMIK 5 HORIZONTAL**

- rrethues dekorativ me 5 pozicione horizontal  
- në përputhje me EN 60669-1

*SURROUND EKONOMIK 5 HORIZONTAL*

- decorative surround 5-gang horizontal  
- in accordance with EN 60669-1

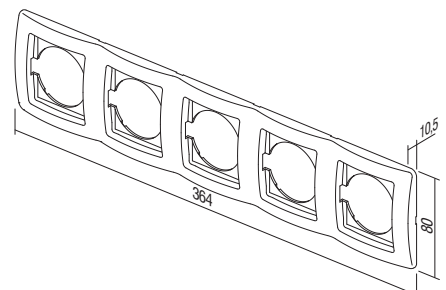

KORNIZA DEKORATIVE ME NGJYRA /  
 COLOR DECORATIVE FRAMES



OE90GR	E GJELBËR / GREEN	OE90YL	E VERDHË / YELLOW	OE90MB	MET. BLU / MET. BLUE
OE90BL	BLU / BLUE	OE90WH	E BARDHË / WHITE	OE90BZ	BRONZ / BRONZE
OE90VO	VJOLLÇË / VIOLET	OE90GY	GRI / GREY	OE90CR	E ARGJENDTË / SILVER
OE90PI	ROZË / PINK	OE90BK	E ZEZË / BLACK	OE90GO	E ARTË / GOLD
OE90RD	E KUQE / RED				





**fontana**



**TEM**







SF10

PW

TI

Iloji type	përshkrimi description	të dhënat teknike technical data	ngjyra colour	të dhënat opsionale 1 optional data 1
SF10	ÇELËS ME 1 DREJTIM SWITCH 1WAY	IP44 10AX 250V~	<input type="checkbox"/> PW e bardhë-mat white-mat	TI llambë neoni+tregues neon lamp+indication
SF11	BUTON MESHTYRJE ME 1 DREJTIM PUSH BUTTON 1WAY	IP44 10A 250V~	<input checked="" type="checkbox"/> GY gri-mat grey-mat	
SF20	ÇELËS 2 POLAR SWITCH 2POLE	IP44 10AX 250V~		
:	:	:		
:	:	:		

ÇELËS ME 1 DREJTIM IP44 10 A X 250 V~



- SF10PW
- SF10GY

- 10 A X 250 V~, Iloji SF10  
- në përputhje me EN 60669-1  
- kontakte për futje telash 1,5-2,5 mm<sup>2</sup>  
*SWITCH 1WAY IP44 10AX 250V~*  
- 10AX 250V~, type SF10  
- in accordance with EN 60669-1  
- plug-in contacts 1.5-2.5mm<sup>2</sup>



ÇELËS ME 1 DREJTIM IP44 10 A X 250 V~ \_\_ TI



- SF10PWTI
- SF10GYTI

- TI tregues+llambë neoni  
- 10 A X 250 V~, Iloji SF10  
- në përputhje me EN 60669-1  
- kontakte për futje telash 1,5-2,5 mm<sup>2</sup>  
*SWITCH 1WAY IP44 10AX 250V~ \_\_ TI*  
- TI indicator+neon lamp  
- 10AX 250V~, type SF10  
- in accordance with EN 60669-1  
- plug-in contacts 1.5-2.5mm<sup>2</sup>



BUTON ME SHTYRJE ME 1 DREJTIM IP44 10 A 250 V~ \_\_ TI



- SF11PWTI
- SF11GYTI

- TI tregues+llambë neoni  
- 10A 250 V~, Iloji SF11  
- në përputhje me EN 60669-1  
- kontakte për futje telash 1,5-2,5 mm<sup>2</sup>  
*PUSH BUTTON 1WAY IP44 10A 250V~ \_\_ TI*  
- TI indicator+neon lamp  
- 10A 250V~, type SF11  
- in accordance with EN 60669-1  
- plug-in contacts 1.5-2.5mm<sup>2</sup>



ÇELËS ME 2 DREJTIME IP44 10 A X 250 V~



- SF20PW
- SF20GY

- 10 A X 250 V~, Iloji SF20  
- në përputhje me EN 60669-1  
- kontakte për futje telash 1,5-2,5 mm<sup>2</sup>  
*SWITCH 2POLE IP44 10AX 250V~*  
- 10AX 250V~, type SF20  
- in accordance with EN 60669-1  
- plug-in contacts 1.5-2.5mm<sup>2</sup>





- SF50PW
- SF50GY

#### ÇELËS ME 2 POZICIONE 1 DREJTIM IP44 10 A X 250 V~

- 10 A X 250 V~, Iloji SF50
- në përputhje me EN 60669-1
- kontakte për futje telash 1,5-2,5 mm<sup>2</sup>

#### SWITCH 2GANG-1WAY IP44 10AX 250V~

- 10AX 250V~, type SF50
- in accordance with EN 60669-1
- plug-in contacts 1.5-2.5mm<sup>2</sup>



- SF51PW
- SF51GY

#### BUTON ME SHTYPJE ME 2 POZICIONE - 1 DREJTIM IP44 10A 250 V~

- 10A 250 V~, Iloji SF51
- në përputhje me EN 60669-1
- kontakte për futje telash 1,5-2,5 mm<sup>2</sup>

#### PUSH BUTTON 2GANG-1WAY IP44 10A 250V~

- 10A 250V~, type SF51
- in accordance with EN 60669-1
- plug-in contacts 1.5-2.5mm<sup>2</sup>



- SF60PW
- SF60GY

#### ÇELËS ME 2 DREJTIME IP44 10 A X 250 V~

- 10 A X 250 V~, Iloji SF60
- në përputhje me EN 60669-1
- kontakte për futje telash 1,5-2,5 mm<sup>2</sup>

#### SWITCH 2WAY IP44 10AX 250V~

- 10AX 250V~, type SF60
- in accordance with EN 60669-1
- plug-in contacts 1.5-2.5mm<sup>2</sup>



- SF60PWTI
- SF60GYTI

#### ÇELËS ME 2 DREJTIME IP44 10 A X 250 V~ \_\_ TI

- TI tregues+llambë neoni
- 10 A X 250 V~, Iloji SF60
- në përputhje me EN 60669-1
- kontakte për futje telash 1,5-2,5 mm<sup>2</sup>

#### SWITCH 2WAY IP44 10AX 250V~ \_\_ TI

- TI indicator+neon lamp
- 10AX 250V~, type SF60
- in accordance with EN 60669-1
- plug-in contacts 1.5-2.5mm<sup>2</sup>



- SF63PW
- SF63GY

#### ÇELËS ME 2 DREJTIME DYSH IP44 10 A X 250 V~

- 10 A X 250 V~, Iloji SF63
- në përputhje me EN 60669-1
- kontakte për futje telash 1,5-2,5 mm<sup>2</sup>

#### SWITCH 2WAY DOUBLE IP44 10AX 250V~

- 10AX 250V~, type SF63
- in accordance with EN 60669-1
- plug-in contacts 1.5-2.5mm<sup>2</sup>



- SF70PW
- SF70GY

#### ÇELËS NDËRMJETËS IP44 10 A X 250 V~

- 10 A X 250 V~, Iloji SF70
- në përputhje me EN 60669-1
- kontakte për futje telash 1,5-2,5 mm<sup>2</sup>

#### SWITCH INTERMEDIATE IP44 10AX 250V~

- 10AX 250V~, type SF70
- in accordance with EN 60669-1
- plug-in contacts 1.5-2.5mm<sup>2</sup>

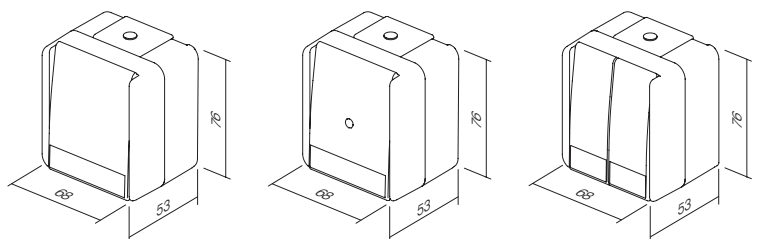



VF10

PW

Iloji type	përshkrimi description	të dhënat teknike technical data	ngjyra colour
VF10	PRIZË SCHUKO+KAPAK SOCKET SCHUKO+COVER	IP44 2P+E 16A 250V~	<input type="checkbox"/> PW e bardhë-mat white-mat  <input type="checkbox"/> GY gri-mat grey-mat

PRIZË SCHUKO+KAPAK IP44 2P+E 16 A 250 V~



- VF10PW
- VF10GY

- kontaktet e vidave 1,5-2,5 mm<sup>2</sup>
- 2P+E schuko+kapak
- 16 A 250 V~, Iloji VF10
- në përputhje me EN 60884-1, CEE7

SOCKET SCHUKO+COVER IP44 2P+E 16A 250V~

- screw contacts 1.5-2.5mm<sup>2</sup>
- 2P+E schuko+cover
- 16A 250V~, type VF10
- in accordance with EN 60884-1, CEE7



PRIZË SCHUKO+KAPAK IP44 2P+E 16 A 250 V~ BV



- VF12PW
- VF12GY

- BV kontakte për futje telash 1,5-2,5 mm<sup>2</sup>
- 2P+E schuko+kapak
- 16 A 250 V~, Iloji VF12
- në përputhje me EN 60884-1, CEE7

SOCKET SCHUKO+COVER IP44 2P+E 16A 250V~ BV

- BV plug-in contacts 1.5-2.5mm<sup>2</sup>
- 2P+E schuko+cover
- 16A 250V~, type VF12
- in accordance with EN 60884-1, CEE7

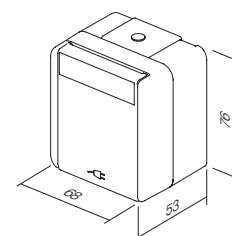

VF10  
VF12



Iloji type	përshkrimi description	të dhënat teknike technical data	ngjyra colour
CF10	PRIZË SET SCHUKO DYSHE HORIZ SOCKET SET SCHUKO DOUBLE HORIZ	2x 2P+E 16A 250V~ IP44	<input type="checkbox"/> PW e bardhë-mat white-mat
CF11	PRIZË SET SCHUKO DYSHE VERT SOCKET SET SCHUKO DOUBLE VERT	2x 2P+E 16A 250V~ IP44	<input checked="" type="checkbox"/> GY gri-mat grey-mat
CF12	PRIZË SCH+ÇELËS 2 DREJTIME HORIZ SOCKET SCH+SWITCH 2WAY HORIZ	16A + 10A 250V~ IP44	
⋮	⋮	⋮	
⋮	⋮	⋮	

#### SET PRIZË SCHUKO DYSHE HORIZONTALE IP44 2x 2P+E 16 A 250 V~



- CF10PW  
 CF10GY

- kontaktet e vidave 1,5-2,5 mm<sup>2</sup>
- 2x 2P+E schuko+kapak horizontale
- 16 A 250 V~, Iloji CF10
- në përputhje me EN 60884-1, CEE7

SOCKET SET SCHUKO DOUBLE  
HORIZONTAL IP44 2x 2P+E 16A 250V~  
- screw contacts 1.5-2.5mm<sup>2</sup>  
- 2x 2P+E schuko+cover horizontal  
- 16A 250V~, type CF10  
- in accordance with EN 60884-1, CEE7



#### SET PRIZË SCHUKO DYSHE VERTIKALE IP44 2x 2P+E 16 A 250 V~



- CF11PW  
 CF11GY

- kontaktet e vidave 1,5-2,5 mm<sup>2</sup>
- 2x 2P+E schuko+kapak vertikale
- 16 A 250 V~, Iloji CF11
- në përputhje me EN 60884-1, CEE7

SOCKET SET SCHUKO DOUBLE VERTICAL  
IP44 2x 2P+E 16A 250V~  
- screw contacts 1.5-2.5mm<sup>2</sup>  
- 2x 2P+E schuko+cover vertical  
- 16A 250V~, type CF11  
- in accordance with EN 60884-1, CEE7



#### PRIZË SCH+SET ÇELËS 2 DREJTIME HORIZONTAL IP44 16 A + 10 A X 250 V~



- CF12PW  
 CF12GY

- vidë (priza), futje (çelësi) kontaktet 1,5-2,5 mm<sup>2</sup>
- 2P+E schuko+kapak + çelës horizontal 2 drejtime
- 16 A + 10 A X 250 V~, Iloji CF12
- në përputhje me standardet EN 60884-1, CEE7, EN 60669-1

SOCKET SCH+SWITCH SET 2WAY  
HORIZONTAL IP44 16A + 10AX 250V~  
- screw (socket), plug-in (switch)  
contacts 1.5-2.5mm<sup>2</sup>  
- 2P+E schuko+cover + switch 2-way horizontal  
- 16A + 10AX 250V~, type CF12  
- in accordance with EN 60884-1, CEE7, EN 60669-1





## PRIZË SCH+SET ÇELËS 2 DREJTIME VERTIKAL IP44 16 A + 10 A X 250 V~



- CF13PW
- CF13GY

- vidë (priza), futje (çelësi)
- kontakte për futje telash 1,5-2,5 mm<sup>2</sup>
- 2P+E schuko+kapak + çelës 2 drejtime vertikal
- 16 A + 10 A X 250 V~, lloji CF13
- në përputhje me standardet EN 60884-1, CEE7, EN 60669-1

## SOCKET SCH+SWITCH 2WAY SET VERTICAL IP44 16A + 10AX 250V~

- screw (socket), plug-in (switch)
- contacts 1.5-2.5mm<sup>2</sup>
- 2P+E schuko+cover + switch 2-way vertical
- 16A + 10AX 250V~, type CF13
- in accordance with EN 60884-1, CEE7, EN 60669-1



## SET PRIZË SCHUKO DYSHE HORIZONTALE IP44 2x 2P+E 16 A 250 V~ BV



- CF14PW
- CF14GY

- BV kontakte për futje telash 1,5-2,5 mm<sup>2</sup>
- 2x 2P+E schuko+kapak horizontale
- 16 A 250 V~, lloji CF14
- në përputhje me EN 60884-1, CEE7

## SOCKET SET SCHUKO DOUBLE HORIZONTAL IP44 2x 2P+E 16A 250V~ BV

- BV plug-in contacts 1.5-2.5mm<sup>2</sup>
- 2x 2P+E schuko+cover horizontal
- 16A 250V~, type CF14
- in accordance with EN 60884-1, CEE7



## SET PRIZË SCHUKO DYSHE VERTIKALE IP44 2x 2P+E 16 A 250 V~ BV



- CF15PW
- CF15GY

- BV kontakte për futje telash 1,5-2,5 mm<sup>2</sup>
- 2x 2P+E schuko+kapak vertikale
- 16 A 250 V~, lloji CF15
- në përputhje me EN 60884-1, CEE7

## SOCKET SET SCHUKO DOUBLE VERTICAL IP44 2x 2P+E 16A 250V~ BV

- BV plug-in contacts 1.5-2.5mm<sup>2</sup>
- 2x 2P+E schuko+cover vertical
- 16A 250V~, type CF15
- in accordance with EN 60884-1, CEE7



## PRIZË+SET ÇELËS SCH+2 DREJTIME HORIZONTAL IP44 16 A + 10 A X 250 V~ BV



- CF16PW
- CF16GY

- BV kontakte për futje telash 1,5-2,5 mm<sup>2</sup>
- 2P+E schuko+kapak + çelës 2 drejtime horizontalisht
- 16 A + 10 A X 250 V~, lloji CF16
- në përputhje me standardet EN 60884-1, CEE7, EN 60669-1

## SOCKET+SWITCH SET SCH+2WAY HORIZONTAL IP44 16A + 10AX 250V~ BV

- BV plug-in contacts 1.5-2.5mm<sup>2</sup>
- 2P+E schuko+cover + switch 2-way horizontal
- 16A + 10AX 250V~, type CF16
- in accordance with EN 60884-1, CEE7, EN 60669-1



## PRIZË SCH+SET ÇELËS 2 DREJTIME VERTIKAL IP44 16 A + 10 A X 250 V~ BV



- CF17PW
- CF17GY

- BV kontakte për futje telash 1,5-2,5 mm<sup>2</sup>
- 2P+E schuko+kapak + çelës 2 drejtime vertikal
- 16 A + 10 A X 250 V~, lloji CF17
- në përputhje me standardet EN 60884-1, CEE7, EN 60669-1

## SOCKET SCH+SWITCH 2WAY SET VERTICAL IP44 16A + 10AX 250V~ BV

- BV plug-in contacts 1.5-2.5mm<sup>2</sup>
- 2P+E schuko+cover + switch 2-way vertical
- 16A + 10AX 250V~, type CF17
- in accordance with EN 60884-1, CEE7, EN 60669-1



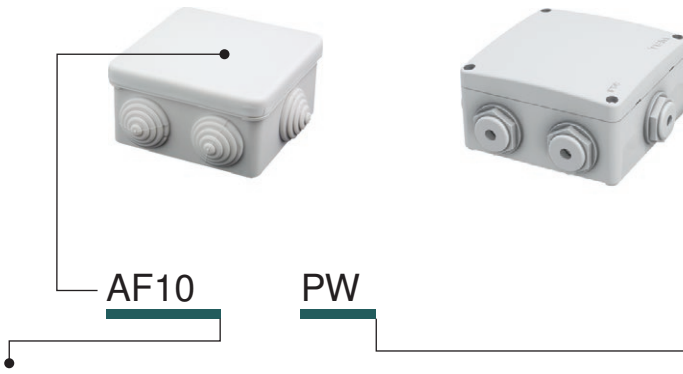

Iloji type	përshkrimi description	të dhënat teknike technical data	ngjyra colour
AF10	KUTI SHPËRNDARJEJE DISTRIBUTION BOX	IP44 RN01	<input type="checkbox"/> PW e bardhë-mat white-mat
AF20	KUTI SHPËRNDARJEJE DISTRIBUTION BOX	IP55 ND01	<input type="checkbox"/> GY gri-mat grey-mat

#### KUTI SHPËRNDARJEJE IP44 RN01



- AF10PW
- AF10GY

- kuti shpërndarjeje me montim në sipërfaqe IP44
- 16 A 400V~
- në përputhje me standardet IEC/EN 60670-1, IEC/EN 60670-22

#### DISTRIBUTION BOX IP44 RN01

- surface mounting distribution box IP44
- 16A 400V~
- in accordance with IEC/EN 60670-1, IEC/EN 60670-22

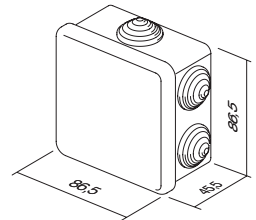

#### KUTI SHPËRNDARJEJE IP55 ND01



- AF20PW
- AF20GY

- kuti lidhjeje me montim në sipërfaqe IP55
- xhuntot përfshihen
- në përputhje me standardet IEC/EN 60670-1, IEC/EN 60670-22

#### DISTRIBUTION BOX IP55 ND01

- surface mounting connection box IP55
- glands included
- in accordance with IEC/EN 60670-1, IEC/EN 60670-22

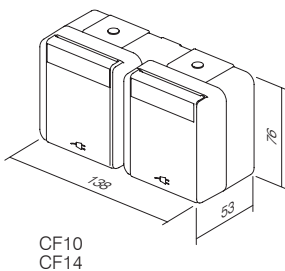
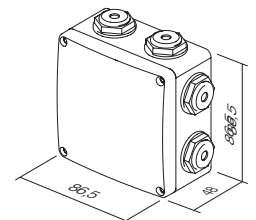

CF10  
CF14

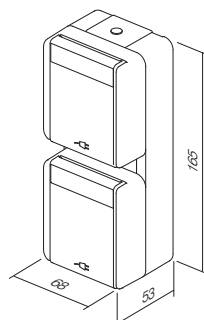

CF11  
CF15

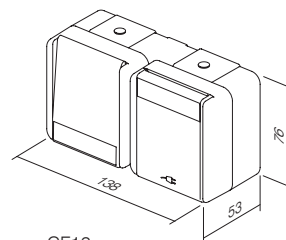

CF12  
CF16

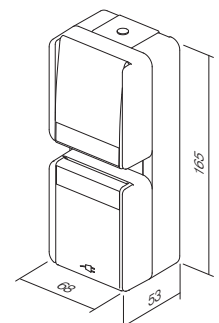

CF13  
CF17

## MODUL

kodi	Përshkrimi i produktit	faqe	kodi	Përshkrimi i produktit	faqe
<b>ÇELËSAT SM</b>			<b>KOMUNIKIMET KM</b>		
SM10	ÇELËS ME 1 DREJTIM 16 AX 250 V- 1M	50	KM10--	PRIZË TV BAZË 0 dB 1M	66
SM11	BUTON ME SHYTPJE ME 1 DREJTIM 16 A 250 V- 1M	50	KM20--	PRIZË TV BAZË 0 dB 2M	66
SM12	ÇELËS ME 1 DREJTIM 20 A 250 V- 1M	50	KM11--	PRIZË TV ME KAPAK FUNDOR 1 dB 1M	66
SM20	ÇELËS 2-POLAR 16 AX 250 V- 1M	50	KM12--	PRIZË TV KALUESE 10 dB 1M	66
SM40	MBYLLËSE ÇELËSI 1-0-2 16 AX 250 V- 1M	51	KM15--	PRIZË SAT BAZË 0 dB 1M	67
SM41	MBYLLËSE BUTONI ME SHYTPJE 1-0-2 16 A 250 V- 1M	51	KM24--	PRIZË SAT BAZË 0 dB 2M	67
SM60	ÇELËS ME 2 DREJTIME 16 AX 250 V- 1M	51	KM16--	PRIZË SAT ME KAPAK FUNDOR 1 dB 1M	67
SM61	BUTON ME SHYTPJE ME 2 DREJTIME 16 A 250 V- 1M	51	KM19--	PRIZË R BAZË 0 dB 1M	68
SM70	ÇELËS NDËRMJETËS 16 AX 250 V- 1M	51	KM29--	PRIZË R BAZË 0 dB 2M	68
SM10--	ÇELËS ME 1 DREJTIM 16 AX 250 V- 1M	52	KM17--	PRIZË SAT-TV ME KAPAK FUNDOR 1 dB 1M	68
SM10--IN	ÇELËS ME 1 DREJTIM 16 AX 250 V- 1M IN	52	KM25--	PRIZË SAT-TV ME KAPAK FUNDOR 1 dB 2M	68
SM11--	BUTON ME SHYTPJE ME 1 DREJTIM 16 A 250 V- 1M	52	KM22--	PRIZË AUDIO 2xRCA 1M	69
SM11--IN01	BUTON ME SHYTPJE ME 1 DREJTIM 16 A 250 V- 1M IN 01	52	KM23--	PRIZË AUDIO ALTOPARLANTË 1M	69
SM11--IN02	BUTON ME SHYTPJE ME 1 DREJTIM 16 A 250 V- 1M IN 02	53	KM26--	PRIZË AUDIO ALTOPARLANTË 2M	69
SM20--NT03	ÇELËS 2-POLAR 16 AX 250 V- 1M NT 03	53	KM30--	PRIZË TEL LT RJ11 6/4 1M	70
SM20--IN	ÇELËS 2-POLAR 16 AX 250 V- 1M IN	53	KM31--	PRIZË TEL BT SEC 6/6 1M	70
SM40--NT10	MBYLLËSE ÇELËSI 1-0-2 16 AX 250 V- 1M NT 10	53	KM36--	PRIZË TEL KS RJ11 6/4 1M	70
SM41--NT10	MBYLLËSE BUTONI ME SHYTPJE 1-0-2 16 A 250 V- 1M __ NT 10	53	KM37--	PRIZË CAT5e KS RJ45 8/8 1M	70
SM60--	ÇELËS ME 2 DREJTIME 16 AX 250 V- 1M	53	KM35--	PËRSHTATËS KS 1M	70
SM61--	BUTON ME SHYTPJE ME 2 DREJTIME 16 A 250 V- 1M	54	KM38--	PËRSHTATËS KS ME MBROJTJE NGA PLUHURI 1M	70
SM62--CD	BUTON ME SHYTPJE ME 2 DREJTIME ME KORDON 16 A 250 V- 1M __ CD	54	KM39--	PRIZË CAT6 SCH KS RJ45 8/8 1M	71
SM70--	ÇELËS NDËRMJETËS 16 AX 250 V- 1M	54	KM50--	PËRSHTATËS KS UNIVERSAL 1M	71
<b>BUTONAT TM</b>			KM40--	PËRSHTATËS PD 1M	71
TM11--	BUTON 1M	55	KM43--	PËRSHTATËS PD ME MBROJTJE NGA PLUHURI 1M	71
TM11--IN	BUTON 1M IN	55	KM46--	PËRSHTATËS R&M 1M	72
TM12--	BUTON 2M	55	KM52--	PËRSHTATËS R&M CAT6A 1M	72
TM12--IN	BUTON 2M IN	55	KM47--	PËRSHTATËS R&M ME MBROJTJE NGA PLUHURI 1M	72
TM13--IL	BUTON 2M ME KAPAK ME MBISHKRIM	56	KM53--	PËRSHTATËS R&M CAT6A ME MBROJTJE NGA PLUHURI 1M	72
TM15--	BUTON 1M 2-POLAR	56	KM45--	PËRSHTATËS LK 1M	73
TM21--	FALSO 1M	56	KA26	PËRSHTATËS NEXANS/SCHRACK 2M	73
TM22--	FALSO 2M	56	KM48--	PËRSHTATËS AT&T SYSTMIX ME MBROJTJE NGA PLUHURI 1M	73
TM31--	DALJE PËR KABLO 1M	56	KM51--	PRIZË USB LLOJIT A 1M	73
<b>SINJALIZIMI IA</b>			<b>AKSESORËT E KOMUNIKIMIT KA</b>		
IA100R	LLAMBË NEONI 230 V- 0,34 W	58	KA10	KONEKTOR KS RJ11 RJ11 6/4	74
IA20--	SINJALIZIMI LED 230 V AC/DC 0,4 W	58	KA11	KONEKTOR KS CAT5e RJ45 8/8	74
IA21--	SINJALIZIMI LED 24 V AC/DC 0,2 W	58	KA12	KONEKTOR KS CAT5eS RJ45 8/8	74
IA22--	SINJALIZIMI LED 12V AC/DC 0,10 W	58	KA15	KONEKTOR KS RJ45 SCHRACK RJ45 8/8	75
IA50	QARK RC 250 V	58	KA16	KONEKTOR KS RJ45 SCHRACK RJ45 8/8	75
<b>ÇELËSAT SP</b>			KA17	KONEKTOR KS CAT6a SCHRACK RJ45 8/8	75
SP10	ÇELËS ME 1 DREJTIM 16 A X 250 V- 1M	57	KA18	KONEKTOR KS RJ45 SCHRACK RJ45 8/8	75
SP11	BUTON ME SHYTPJE ME 1 DREJTIM 16 A 250 V- 1M	57	KA27	KONEKTOR KS HDMI	75
SP12	ÇELËS ME 1 DREJTIM 20 A X 250 V- 1M	57	KA28	KABLOJA KS HDMI	75
SP20	ÇELËS 2 POLAR 16 A X 250 V- 1M	57			
SP40	MBYLLËSE ÇELËSI 1-0-2 16 A X 250 V- 1M	58			
SP41	MBYLLËSE BUTONI ME SHYTPJE 1-0-2 16 A 250 V- 1M	58			
SP60	ÇELËS ME 2 DREJTIME 16 A X 250 V- 1M	58			
SP61	BUTON ME SHYTPJE ME 2 DREJTIME 16 A 250 V- 1M	58			
SP70	ÇELËS NDËRMJETËS 16 A X 250 V- 1M	58			
<b>PRIZAT VM</b>					
VM10--	PRIZË SCHUKO+KS 2P+E 16 A 250 V- 2M	62			
VM11--	PRIZË SCHUKO+KS+KAPAK 2P+E 16 A 250 V- 2M	62			
VM20--	PRIZË EVROPIANE+KS 2P 10 A 250 V- 1M	63			
VM40--	PRIZË FRANCEZE+KS 2P+E 16 A 250 V- 2M	63			
VM41--	PRIZË FRANCEZE+KS+KAPAK 2P+E 16 A 250 V- 2M	63			
VM30--	PRIZË ITALIANE P17/11+KS 2P+E 16 A 250 V- 1M	63			
VM31--	PRIZË SCHUKO/ITALIANE P17/11+KS 2P+E 16 A 250 V- 2M	63			
VM32--	PRIZË SCHUKO/ITALIANE P30+KS 2P+E 16 A 250 V- 2M	64			
VM33--	PRIZË ITALIANE P11+KS 2P+E 10 A 250 V- 1M	64			
VM21--	PRIZË EVROPIANE/AMERIKANE+KS 2P 16 A 250 V- 1M	64			
VM52--	PRIZË BRITANIKE BS 1363+KS 2P+E 13 A 250 V- 2M	64			
VM55--	PRIZA MULTISTANDARDE+KS 2P+E 13A 250V- 2M	64			
VM80	MBROJTËS NGA MBITENSIONI MPE MINI 275 V/50 Hz	64			

kodi	Përshkrimi i produktit	faqe	kodi	Përshkrimi i produktit	faqe
<b>LIDHJET ELEKTRONIKE EM</b>			<b>KAPAKËT MBULUES LINE OL</b>		
EM12--	REOSTAT RROTULLUES/2 DREJTIME RL 300 W 1M	76	OL10--	KAPAK MBULUES LINE 1/2M	112
EM13--	REOSTAT RROTULLUES/2 DREJTIME LED 60 W 1M	77	OL20--	KAPAK MBULUES LINE 2M	112
EM14--	REOSTAT RROTULLUES/2 DREJTIME LED 180 W 1M	77	OL24--	KAPAK MBULUES LINE 2x2M	112
EM15--	REOSTAT RROTULLUES R 250 W 1M	78	OL26--	KAPAK MBULUES LINE 3x2M	112
EM23	REOSTAT ME MONTIM NË KUTI R (250 W), (RC, RL 200VA)	78	OL28--	KAPAK MBULUES LINE 4x2M	112
EM16--	1-10 V ÇELËSI RROTULLUES ME DY DREJTIME I REOSTATIT	79	OL29--	KAPAK MBULUES LINE 5x2M	112
EM17	MODULI I KONTROLLIT MZC për EM18	80	OL13--	KAPAK MBULUES LINE 1/3M	113
EM18	REOSTAT ME MONTIM NË KUTI LED 250 W	80	OL30--	KAPAK MBULUES LINE 3M	113
EM19	REOSTAT ME MONTIM NË KUTI DC LED 96 W	81	OL40--	KAPAK MBULUES LINE 4M	113
EM25--	ÇELËS/REOSTAT UNIVERSAL RLC 0-300 W 2M	82	OL70--	KAPAK MBULUES LINE 7M	113
EM26--	NJËSI KONTROLLI ME BUTON ME SHTYPJE 2M	84	OL71--	KAPAK MBULUES LINE 2x7M	113
EM25PPOL20	SET ÇELËS/REOSTAT RLC 0-300 W 2M PP OL20	84	OL23--	KAPAK MBULUES LINE 2/3M	113
EM27	FILTËR FREKUENÇE	85	<b>KAPAKËT MBULUES SOFT OS</b>		
EM28--	FOLE PËR SIGURESË TË SHKRIRË 230 V AC, 50 Hz 1M	85	OS10--	KAPAK MBULUES 1/2M	116
EM29	SIGURESË	85	OS20--	KAPAK MBULUES SOFT 2M	116
EM31--	ÇELËS IR 5 A 230 V- 1M	85	OS24--	KAPAK MBULUES SOFT 2x2M	116
EM32--	ÇELËS IR 5 A 230 V- 2M	86	OS26--	KAPAK MBULUES SOFT 3x2M	116
EM33--	ÇELËS ME SENSOR 5A 230V- 1M	86	OS28--	KAPAK MBULUES SOFT 4x2M	116
EM38--	TERMOSTATI I NGROHJES 5(2)A 230V- 2M	89	OS13--	KAPAK MBULUES SOFT 1/3M	117
EM39--	TERMOSTAT NGROHJEJE/FTOHJEJE 3(1,5)A 230V- 2M	89	OS30--	KAPAK MBULUES SOFT 3M	117
NM39	KORNIZË MONTIMI ME VIDA PËR TERMOSTATE FANTINI COSMI 3M	90	OS40--	KAPAK MBULUES SOFT 4M	117
EM40--	ÇELËS KARTE PËR KURSIMI E ENERGJISË 3 A 250 V- 3M	90	OS70--	KAPAK MBULUES SOFT 7M	117
EM46--	ÇELËS ME KARTË 16 A / 230 VAC, 50 Hz 3M	91	OS71--	KAPAK MBULUES SOFT 2x7M	117
EM44--	ÇELËS KARTE PËR KURSIMI TË ENERGJISË RF HF 13,56 MHz 3M	91	OS72--	KAPAK MBULUES SOFT 2x7M	117
EM47	KARTË ISO	91	OS23--	KAPAK MBULUES SOFT 2/3M	117
EM49	NJËSI KONTROLLI E KURSIMIT TË ENERGJISË 2x16 A 250 V-	92	<b>KAPAKËT MBULUES PURE OP</b>		
EM45	SHPËRNDARËS SPL-1	92	OP20--	KAPAK MBULUES PURE 2M	122
EM60--	PRIZË PËR RROJË 230 V-/120 V- 3M	93	OP24--	KAPAK MBULUES PURE 2x2M	122
EM57	DITË EMERGJENCE 230 V- 50 Hz 0,5 W, NiMH 2h 2M	93	OP26--	KAPAK MBULUES PURE 3x2M	122
EM55	DITË EMERGJENCE LED 250 V- 0,90 W, NiCd 3h 7M	93	OP28--	KAPAK MBULUES PURE 4x2M	122
EM67--	NJËSI USB E FURNIZIMI ME ENERGJI 5 V 2,4 A 1M	94	OP13--	KAPAK MBULUES PURE 1/3M	123
EM68--	NJËSI USB E FURNIZIMIT ME ENERGJI 5 V 3,0 A	94	OP30--	KAPAK MBULUES PURE 3M	123
EM69--	NJËSIA E FURNIZIMIT ME ENERGJI USB PD 20W	95	OP40--	KAPAK MBULUES PURE 4M	123
EM50--	NJËSI LED NJËNGJYRËSHE AMBIENT 250 V- 0,8 W 2M	96	OP70--	KAPAK MBULUES PURE 7M	123
EM51--	LLAMBË LED ME DY NGJYRA 250 V- 2 x 0,4 W 2M	96	OP23--	KAPAK MBULUES PURE 2/3M	123
EM52--	LLAMBË LED 3D ME DY NGJYRA 250 V- 2 x 0,4 W 2M	96	<b>KAPAKËT MBULUES EDGE OG</b>		
EM71--	ÇELËS ME GJURMË GISHTI BIOPASS 2M	97	OG10--P	KAPAK MBULUES EDGE 1/2M	126
EM82--	KOHËMATËS ME SHUMË FUNKSIONE EM82	98	OG20--P	KAPAK MBULUES EDGE 2M	126
EM80--	ÇELËS, PA PREKJE 10 A 240 V-	100	OG13--P	KAPAK MBULUES EDGE 1/3M	127
EM81--	ÇELËS, PA PREKJE	100	OG30--P	KAPAK MBULUES EDGE 3M	127
EM90--	SINJALIZUES 8 VA 230 V-1M	101	OG40--P	KAPAK MBULUES EDGE 4M	127
EM91--	SINJALIZUES 8 VA 12 V-1M	101	OG70--P	KAPAK MBULUES EDGE 7M	127
EM92--	ZILE 8 VA 230 V-1M	101	OG23--P	KAPAK MBULUES EDGE 2/3M	127
EM93--	ZILE 8 VA 12V-1M	101	<b>KAPAKËT MBULUES EDGE OG</b>		
EM94--	ZILE ELEKTRONIKE 230V- 6mA rms 1M	102	OG10--M	KAPAK MBULUES EDGE 1/2M	129
EM95--	KONTROLL VOLUMI 100 V LINJË AUDIO 35 W 2M	102	OG20--M	KAPAK MBULUES EDGE 2M	129
EM96--	KONTROLL VOLUMI 4-8 Ω 35 W 2M	102	OG24--M	KAPAK MBULUES EDGE 2x2M	129
<b>SETI CM</b>			OG26--M	KAPAK MBULUES EDGE 3x2M	129
CM10--	SET PRIZASH 2x SCHUKO 2P+E 16 A 250 V- 4M	103	OG28--M	KAPAK MBULUES EDGE 4x2M	129
CM11--	SET PRIZASH 3x SCHUKO 2P+E 16 A 250 V- 7M	103	OG13--M	KAPAK MBULUES EDGE 1/3M	130
CM15	SET LIDHJEJE 3x1,5 mm <sup>2</sup> 1M	104	OG30--M	KAPAK MBULUES EDGE 3M	130
CM16	SET LIDHJEJE 3x2,5 mm <sup>2</sup> 2M	104	OG40--M	KAPAK MBULUES EDGE 4M	130
CM17	SET VIDASH 3,5x20	104	OG70--M	KAPAK MBULUES EDGE 7M	130
CM18	SET VIDASH 3,5x35	104	OG23--M	KAPAK MBULUES EDGE 2/3M	130
CM19	SET VIDASH 3,5x50	104	<b>KORNIZAT E MONTIMIT NM</b>		
CM22--	SET ÇELËSASH IP44 2M	104	NM10	KORNIZË MONTIMI ME KUNJA KAPËSE 1/2M	136
CM23--	SET PRIZASH IP44 2M	104	NM11	KORNIZË MONTIMI PA VIDA 1/2M	136
CM25--OL	SET ÇELËSASH PËR BANJË 3x20 A 250 V- 4M OL	104	NM20	KORNIZË MONTIMI ME KUNJA KAPËSE 2M	136
CM25--OS	SET ÇELËSASH PËR BANJË 3x20 A 250 V- 4M OS	104	NM21	KORNIZË MONTIMI PA VIDA 2M	136
NM41	SET KORNIZË MONTIMI PËR BANJË 4M	105	NM24	KORNIZË MONTIMI METALIKE ME KUNJA KAPËSE 2M	137
OL41--	SET KAPAKU MBULUES LINE PËR BANJË	105	NM25	KORNIZË MONTIMI METALIKE PA VIDA 2M	137
OS41--	SET KAPAKU MBULUES SOFT PËR BANJË	105	NM26	KORNIZË MONTIMI 2M E PËRFORCUAR ME KTHETRA	137
<b>PROGRAMI ANTIBAKTERIAL AW</b>			NM27	KORNIZË MONTIMI 2 M E PËRFORCUAR PA VIDA	137
TM11AW	BUTON 1M	107	NM23	KORNIZË MONTIMI ME KUNJA KAPËSE 2/3M	137
TM11AWIN	BUTON 1M IN	107	NM30	KORNIZË MONTIMI ME VIDA 3M	138
TM12AW	BUTON 2M	107	NM40	KORNIZË MONTIMI ME VIDA 4M	138
TM12AWIN	BUTON 2M IN	107	NM70	KORNIZË MONTIMI ME VIDA 7M	138
TM21AW	FALSO 1M	107	NM72	KORNIZË MONTIMI ME VIDA 2x7M	138
TM22AW	FALSO 2M	107	NM32	KORNIZË MONTIMI ME VIDA 2/3M	138
VM10AW	PRIZË SCHUKO+KS 2P+E 16 A 250 V- 2M	108			
VM11AW	PRIZË SCHUKO+KS+KAPAK 2P+E 16 A 250 V- 2M	108			
VM20AW	PRIZË EVROPIANE+KS 2P 10 A 250 V- 1M	108			
KM11AW	PRIZË TV ME KAPAK FUNDOR 1 dB 1M	108			
KM35AW	PËRSHTATËS KS 1M	108			
OS20AW	KAPAK MBULUES SOFT 2M	109			
OS24AW	KAPAK MBULUES SOFT 2x2M	109			
OS26AW	KAPAK MBULUES SOFT 3x2M	109			
OS30AW	KAPAK MBULUES SOFT 3M	109			
OS40AW	KAPAK MBULUES SOFT 4M	109			
OS70AW	KAPAK MBULUES SOFT 7M	109			



## KUTITË

kodi	Përshkrimi i produktit	faqe
<b>KUTITË E RRUMBULLAKËTA</b>		
DE10	KUTI E RRUMBULLAKËT PËR TULLË SM60-01	142
DE11	KUTI E RRUMBULLAKËT PËR TULLË TË THELLË SM60-06	142
DE30	KAPËSE E KOMBINUAR SM60-03	142
DE31	KAPËSE E KOMBINUAR SM60-04	142
DE12	KUTI E RRUMBULLAKËT PËR TULLË 65-46	143
DE13	KUTI E RRUMBULLAKËT PËR TULLË 65-60	143
DE14	PJESË SHITESË PËR MD 65-46	143
DE32	KAPËSE E KOMBINUAR MD 65-71	143
DE33	KAPËSE E KOMBINUAR MD 65-91	143
DE20	KAPAK MBROJTËS PËR KUTI 60	143
DE21	KAPAK MBROJTËS PËR KUTI 65	143
DE22	KAPAK DEKORATIV PËR KUTI SM60	143
HE10	KUTI E RRUMBULLAKËT PËR MUR BOSH SM68x40	146
HE11	KUTI E RRUMBULLAKËT PËR MUR BOSH SM68x55	146
BE10	KUTI E RRUMBULLAKËT PËR BETON 60-49	146
BE11	KUTI E RRUMBULLAKËT PËR BETON 60-77	146
BE20	KUNDËR-SUPORT KUTIE PËR BETON	146
BE21	KUTI PËR BETON PËR BLOKUES TUBI 16	146
<b>KUTITË DREJTKËNDORE</b>		
DM30	KUTI DREJTKËNDORE PËR TULLË PM3	150
DM31	KUTI DREJTKËNDORE PËR TULLË PM3-65	150
DM40	KUTI DREJTKËNDORE PËR TULLË PM4	150
DM41	KUTI DREJTKËNDORE PËR TULLË PM4-65	150
DM70	KUTI DREJTKËNDORE PËR TULLË PM7	151
DM71	KUTI DREJTKËNDORE PËR TULLË PM7-65	151
DM72	KUTI DREJTKËNDORE PËR TULLË PM72-65	151
DM80	PJESË DISTANCUESE PËR KUTI PM	151
DM33	KAPAK MBROJTËS PËR KUTI PM3	152
DM34	KAPAK DEKORATIV PËR KUTI PM3	152
DM43	KAPAK MBROJTËS PËR KUTI PM4	152
DM44	KAPAK DEKORATIV PËR KUTI PM4	152
DM73	KAPAK MBROJTËS PËR KUTI PM7	152
DM74	KAPAK DEKORATIV PËR KUTI PM7	152
DM75	KAPAK DEKORATIV PËR KUTI PM72	153
HM30	KUTI DREJTKËNDORE PËR MUR BOSH VM3	154
HM40	KUTI DREJTKËNDORE PËR MUR BOSH VM4	154
HM70	KUTI DREJTKËNDORE PËR MUR BOSH VM7	154
HM72	KUTI DREJTKËNDORE PËR MUR BOSH VM72	154
BM30	KUTI DREJTKËNDORE PËR BETON BM3	155
BM40	KUTI DREJTKËNDORE PËR BETON BM4	155
BM70	KUTI DREJTKËNDORE PËR BETON BM7	155
BM80	KAPËSE FIKSUESE E KOMBINUAR BM	155
BM82	PJESË DISTANCUESE PËR KUTI BM	155
<b>KUTITË LIDHËSE</b>		
DW10	KUTI E RRUMBULLAKËT TULLË PËR LIDHJE DSM78	158
HW10	KUTI E RRUMBULLAKËT MUR BOSH PËR LIDHJE SM78x45	158
DE23	KAPAK DEKORATIV PËR KUTI SM78	158
DE24	KAPAK MBROJTËS PËR KUTI 78	158
HW20	KUTI KATRORE TULLË PËR LIDHJE SM105x105	158
<b>AKSESORËT E LIDHJEVE</b>		
UW10--	BLLOQE TERMINALESH ME 1 RADHË TË MBYLLURA PC 2x2,5 mm <sup>2</sup> 10P	160
UW11--	BLLOQE TERMINALESH ME 1 RADHË TË MBYLLURA PC 2x4 mm <sup>2</sup> 10P	160
UW12--	BLLOQE TERMINALESH ME 1 RADHË TË MBYLLURA PC 2x6 mm <sup>2</sup> 10P	160
UW15--	BLLOQE TERMINALESH ME 1 RADHË PA 2x2,5 mm <sup>2</sup> 12P	160
UW16--	BLLOQE TERMINALESH ME 1 RADHË TË MBYLLURA PA 2x4 mm <sup>2</sup> 12P	160
UW17--	BLLOQE TERMINALESH ME 1 RADHË TË MBYLLURA PA 2x6 mm <sup>2</sup> 12P	160
UW29--	BLLOQE TERMINALESH ME 2 RADHË PP 1,0-4,0 mm <sup>2</sup> 12P	160
UW30--	BLLOQE TERMINALESH ME 2 RADHË PP 1,5-6,0 mm <sup>2</sup> 12P	160
UW31--	BLLOQE TERMINALESH ME 2 RADHË PP 2,5-10 mm <sup>2</sup> 12P	160
UW32--	BLLOQE TERMINALESH ME 2 RADHË PP 4,0-16 mm <sup>2</sup> 12P	160
UW25--	BLLOQE TERMINALESH ME 2 RADHË PA 1,0-4,0 mm <sup>2</sup> 12P	161
UW26--	BLLOQE TERMINALESH ME 2 RADHË PA 1,5-6,0 mm <sup>2</sup> 12P	161
UW27--	BLLOQE TERMINALESH ME 2 RADHË 2,5-10 mm <sup>2</sup> 12P	161
UW28--	BLLOQE TERMINALESH ME 2 RADHË PA 4,0-16 mm <sup>2</sup> 12P	161
UW40--	KONEKTORË PËR FUTJE TELASH PA 1,5 mm <sup>2</sup> 3P	161
UW41--	KONEKTORË PËR FUTJE TELASH PA 1,5 mm <sup>2</sup> 5P	161
UW42--	KONEKTORË PËR FUTJE TELASH PA 1,5 mm <sup>2</sup> 8P	161
UW45--	KONEKTORË PËR FUTJE TELASH PA 2,5 mm <sup>2</sup> 3P	161
UW46--	KONEKTORË PËR FUTJE TELASH PA 2,5 mm <sup>2</sup> 4P	161
UW47--	KONEKTORË PËR FUTJE TELASH PA 2,5 mm <sup>2</sup> 5P	161
UW50--	KONEKTORË PËR FUTJE TELASH PA 2,5 mm <sup>2</sup> 2/1P	161

## shpërndarja

kodi	Përshkrimi i produktit	faqe
<b>KUTI CUBO IP20 AC</b>		
AC11--	KUTI NO CUBO ME KAPAK TË PASMË ANËSOR IP20 1M	164
AC21--	KUTI NO CUBO ME KAPAK TË PASMË ANËSOR IP20 2M	164
AC41--	KUTI NO CUBO ME KAPAK TË PASMË ANËSOR IP20 4M	164
AC61--	KUTI NO CUBO ME KAPAK TË PASMË ANËSOR IP20 6M	164
<b>KUTI CUBO IP55 AQ</b>		
AQ20--	KUTI NO CUBO IP55 2M	165
AQ22--	KUTI NO CUBO IP55 2x2M	165
AQ30--	KUTI NO CUBO IP55 3M	165
AQ21--	KUTI PO CUBO IP55 2M	166
AQ31--	KUTI PO CUBO IP55 3M	166
<b>SISTEME KANALINASH ALUMINI MA</b>		
RT10	PËRSHTATËS MA 162	167
RT12--	KAPAK MBULUES MA 92 2/3M	167
RT14--	KAPAK MBULUES MA 162 4M	167
RT17--	KAPAK MBULUES MA 162 7M	167
RT20--	BAZË PËR KANALINA MA 130x65	168
RT21--	BAZË PËR KANALINA MA 165x65	168
RT25--	KAPAK I PËRPARMË MA 92	168
RT30	RAFT KABLLOSH MA 43	168
RT31	RAFT KABLLOSH MA 43 AL	168
RT32	RAFT KABLLOSH MA 43 AL DYSH	168
RT35--	ELEMENT FUNDOR BLOKUES MA 130x65	169
RT36--	ELEMENT FUNDOR BLOKUES MA 165x65	169
RT38	SET PJESËSH BASHKUESE MA 65	169
RT40--	KËND UNIVERSAL MA 130x65	169
RT41--	KËND UNIVERSAL MA 165x65	169
RT42	PJESË TOKËZIMI MA 2x A6,3	169
RT43--	RAKORD L MA 130x65 / 130	169
RT44--	RAKORD L MA 165x65 / 130	170
RT47--	RAKORD L MA 165x65 / 165	170
RT45--	RAKORD T MA 130x65 / 130	170
RT46--	RAKORD T MA 165x65 / 130	170
RT48--	RAKORD T MA 165x65 / 165	170
RT50--	PLLAKËZ FIKSUESE MA NJËSHE 130x65	171
RT51--	PLLAKËZ FIKSUESE MA DYSHE 130x65	171
RT52--	KABINË SHËRBIMI MA 130x65x500	171
RT53--	KABINË SHËRBIMI MA DYSHE 130x65x500	171
<b>KUTI DYSHEMEJE MT</b>		
RB50	BAZË KUTIE DYSHEMEJE 4M	173
RB60	INSERT PËR KUTI SHPËRNDARJEJE PËR DYSHEME 4M	173
RB65S1	KAPAK PËR KUTI SHPËRNDARJEJE PËR DYSHEME 4M	173
RB51	BAZË KUTIE DYSHEMEJE 7M	173
RB61	INSERT PËR KUTI SHPËRNDARJEJE PËR DYSHEME 7M	173
RB66S1	KAPAK PËR KUTI SHPËRNDARJEJE PËR DYSHEME 7M	173
RB52	BAZË KUTIE DYSHEMEJE 2x7M	174
RB62	INSERT PËR KUTI SHPËRNDARJEJE PËR DYSHEME 2X7M	174
RB67S2	KAPAK PËR KUTI SHPËRNDARJEJE PËR DYSHEME 2X7M	174
RB53	BAZË KUTIE DYSHEMEJE 4x7M	174
RB62	INSERT PËR KUTI SHPËRNDARJEJE PËR DYSHEME 2X7M	174
RB68S2	KAPAK PËR KUTI SHPËRNDARJEJE PËR DYSHEME 4X7M	174
RB55S1	KUTI DYSHEMEJE ME KAPAK PËR DYSHEME DYSHE 4M	175
RB60	INSERT PËR KUTI SHPËRNDARJEJE PËR DYSHEME 4M	175
RB56S1	KUTI DYSHEMEJE ME KAPAK PËR DYSHEME DYSHE 7M	176
RB61	INSERT PËR KUTI SHPËRNDARJEJE PËR DYSHEME 7M	176
RB57S2	KUTI DYSHEMEJE ME KAPAK PËR DYSHEME DYSHE 2X7M	176
RB62	INSERT PËR KUTI SHPËRNDARJEJE PËR DYSHEME 2X7M	176
RB58S2	KUTI DYSHEMEJE ME KAPAK PËR DYSHEME DYSHE 4X7M	176
RB62	INSERT PËR KUTI SHPËRNDARJEJE PËR DYSHEME 2X7M	176
RB10	PËRSHTATËS PËR SHINË DIN 35 mm 1M	177
RB11	PËRSHTATËS PËR SHINË DIN 35 mm 2M	177

# LOGIQ —

kodi	Përshkrimi i produktit	faqe
<b>ÇELËSAT SQ</b>		
SQ10--XO	ÇELËS ME 1 DREJTIM 10 AX 250 V-	198
SQ10--INXO	ÇELËS ME 1 DREJTIM 10 AX 250 V- __ IN	198
SQ11--XO	BUTON ME SHTYRJE ME 1 DREJTIM 10 A 250 V-	198
SQ11--IN01XO	BUTON ME SHTYRJE ME 1 DREJTIM 10 A 250 V- __ IN 01	198
SQ11--IN02XO	BUTON ME SHTYRJE ME 1 DREJTIM 10 A 250 V- __ IN 02	199
SQ22--IN03XO	ÇELËS 2-POLAR 16 AX 250 V- __ IN 03	199
SQ50--XO	ÇELËS ME 2 VENDE - 1 DREJTIM 10 AX 250 V-	199
SQ51--XO	BUTON ME SHTYRJE ME 2 VENDE - 1 DREJTIM 10 A 250 V-	199
SQ52--NT09XO	MBYLLËSE ÇELËSI 10 AX 250 V- __ NT 09	199
SQ53--NT09XO	MBYLLËSE BUTONI ME SHTYRJE 10 A 250 V- __ NT 09	199
SQ60--XO	ÇELËS ME 2 DREJTIME 10 AX 250 V-	199
SQ63--XO	ÇELËS DYSH ME 2 DREJTIME 10 AX 250 V-	200
SQ70--XO	ÇELËS NDËRMJETËS 10 AX 250 V-	200
<b>SINJALIZIMI IA</b>		
IA10--	LLAMBË NEONI 230 V- 0,34 W	201
IA20--	SINJALIZIMI LED 230 V- AC/DC 0,4 W	201
IA21--	SINJALIZIMI LED 24 V AC/DC 0,2W	201
IA22--	SINJALIZIMI LED 12 V AC/DC 0,1W	201
<b>PRIZAT VQ</b>		
VQ10--XO	PRIZË SCHUKO 2P+E 16 A 250 V- __ XO	204
VQ11--XO	PRIZË SCHUKO+KAPAK 2P+E 16 A 250 V- __ XO	204
VQ12--XO	PRIZË SCHUKO 2P+E 16 A 250 V- BV __ XO	204
VQ13--XO	PRIZË SCHUKO+KAPAK 2P+E 16 A 250 V- BV __ XO	204
VQ40--XO	PRIZË FRANCEZE 2P+E 16 A 250 V- __ XO	205
VQ41--XO	PRIZË FRANCEZE+KAPAK 2P+E 16 A 250 V- __ XO	205
VQ16--	PRIZË SCHUKO DYSHE 2P+E 16 A 250 V-	205
VQ16--F	PRIZË SCHUKO DYSHE 2P+E 16 A 250 V-	205
VQ42--XO	PRIZË FRANCEZE 2P+E 16 A 250 V- BV __ XO	206
VQ43--XO	PRIZË FRANCEZE+KAPAK 2P+E 16 A 250 V- BV __ XO	206
VQ46--XO	PRIZË FRANCEZE DYSHE 2P+E 16 A 250 V-	206
VQ46--F	PRIZË FRANCEZE DYSHE 2P+E 16 A 250 V-	206
<b>KOMUNIKIMET KQ</b>		
KQ10--XO	PRIZË TV BAZË 0 dB	207
KQ11--XO	PRIZË TV-R ME KAPAK FUNDOR 1 dB	207
KQ12--XO	PRIZË TV-R KALUESE 10 dB	208
KQ16--XO	PRIZË SAT-TV-R ME KAPAK FUNDOR 3 dB	208
KQ22--XO	PRIZË AUDIO 2xRCA	208
KQ23--XO	PRIZË AUDIO PËR ALTOPARLANTË	208
KQ36--XO	PRIZË TEL KS RJ11 6/4	208
KQ37--XO	PRIZË CAT5e KS RJ45 8/8	206
KQ38--XO	PRIZË TEL KS DYSHE 2x RJ11 6/4	206
KQ39--XO	PRIZË CAT5e KS DYSHE 2x RJ45 8/8	206
KQ35--XO	PRIZË TEL LT RJ11 6/4	206
KQ40--XO	PRIZË CAT6s KS DYSHE 2x RJ45 8/8 E HOLLË	206
KQ41--XO	PRIZË CAT6s KS DYSHE 2x RJ45 8/8 E HOLLË	206
<b>LIDHJET ELEKTRONIKE EQ</b>		
EQ15--XO	REOSTAT RROTULLUES ME 2 DREJTIME RL 400 W	210
EQ16--XO	REOSTAT RROTULLUES ME 2 DREJTIME RLC 400 W	210
EQ19--XO	REOSTAT RROTULLUES ME 2 DREJTIME LED 100 W	210
EQ32--XO	ÇELËS IR 5 A 230 V-	212
EQ35--XO	TERMOSTAT PËR NGROHJE 10 A 230 V-	212
EQ36--XO	TERMOSTAT PËR NGROHJE/FTOHJE 5 A 230V-	212
EQ37--XO	NGROHJE ME TERMOSTAT NGË DYSHEMEJA 16 A 230 V-	213
EQ68--XO	NJËSI USB E FURNIZIMIT ME ENERGJI 5 V 3,0 A	213
EQ01--XO	RADIO ME MONTIM RRAFSH + ALTOPARLANT DAB BLUETOOTH	214
EQ02--XO	ALTOPARLANT ME MONTIM RRAFSH	214
<b>KAPAKËT PQ</b>		
PQ10--XO	TAPË	215
PQ30--	KAPAK TAE/TDO	215
<b>RRETHUESE OQ</b>		
OQ10--	KAPAK MBULUES BOLD 1	216
OQ20--	KAPAK MBULUES BOLD 2	216
OQ30--	KAPAK MBULUES BOLD 3	217
OQ40--	KAPAK MBULUES BOLD 4	217
OQ50--	KAPAK MBULUES BOLD 5	217
<b>RRETHUESE OF</b>		
OF10--	KAPAK MBULUES FLAT 1	218
OF20--	KAPAK MBULUES FLAT 2	218
OF30--	KAPAK MBULUES FLAT 3	219
OF40--	KAPAK MBULUES FLAT 4	219
OF50--	KAPAK MBULUES FLAT 5	219
<b>RRETHUESE OR</b>		
OR10--	KAPAK MBULUES PRIME 1	220
OR20--	KAPAK MBULUES PRIME 2	220
OR30--	KAPAK MBULUES PRIME 3	221
OR40--	KAPAK MBULUES PRIME 4	221

kodi	Përshkrimi i produktit	faqe
<b>ÇELËSAT SE</b>		
SE10	ÇELËS ME 1 DREJTIM 10 AX 250 V-	232
SE11	BUTON ME SHTYPJE ME 1 DREJTIM 10 A 250 V-	232
SE22	ÇELËS 2-POLAR 16 AX 250 V-	232
SE50	ÇELËS ME 2 VENDE - 1 DREJTIM 10 AX 250 V-	232
SE51	BUTON ME SHTYPJE ME 2 VENDE - 1 DREJTIM 10 A 250 V-	233
SE52	MBYLLËSE ÇELËSI 10 AX 250 V-	233
SE53	MBYLLËSE BUTONI ME SHTYPJE 10 A 250 V-	233
SE60	ÇELËS ME 2 DREJTIME 10 AX 250 V-	233
SE63	ÇELËS DYSH ME 2 DREJTIME 10 AX 250 V-	233
SE70	ÇELËS NDËRMJETËS 10 AX 250 V-	233
SE10--	ÇELËS ME 1 DREJTIM 10 AX 250 V-	234
SE10--IN	ÇELËS ME 1 DREJTIM 10 AX 250 V- IN	234
SE11--	BUTON ME SHTYPJE ME 1 DREJTIM 10 A 250 V-	234
SE11--TI50	BUTON ME SHTYPJE ME 1 DREJTIM 10 A 250 V- TI 50	234
SE11--TI51	BUTON ME SHTYPJE ME 1 DREJTIM 10 A 250 V- TI 51	234
SE11--IL	BUTON ME SHTYPJE ME 1 DREJTIM 10 A 250 V- IL	234
SE22--IN03	ÇELËS 2-POLAR 16 AX 250 V- IN 03	234
SE50--	ÇELËS ME 2 VENDE - 1 DREJTIM 10 AX 250 V-	235
SE51--	BUTON ME SHTYPJE ME 2 VENDE - 1 DREJTIM 10 A 250 V-	235
SE52--NT09	MBYLLËSE ÇELËSI 10 AX 250 V- NT 09	235
SE53--NT09	MBYLLËSE BUTONI ME SHTYPJE 10 A 250 V- NT 09	235
SE60--	ÇELËS ME 2 DREJTIME 10 AX 250 V-	235
SE63--	ÇELËS DYSH ME 2 DREJTIME 10 AX 250 V-	235
SE70--	ÇELËS NDËRMJETËS 10 AX 250 V-	235
<b>BUTONAT TE</b>		
TE10--	BUTON ME 1 VEND	236
TE10--IN	TREGUES BUTONI	236
TE13--IL	BUTON ME KAPAK ME MBISHKRIM IL	236
TE11--	BUTON ME 2 VENDE	236
<b>SINJALIZIMI IA</b>		
IA10--	LLAMBË NEONI 230 V- 0,34 W	237
IA20--	SINJALIZIMI LED 230 V- AC/DC 0,4 W	237
IA21--	SINJALIZIMI LED 24 V AC/DC 0,2W	237
IA22--	SINJALIZIMI LED 12 V AC/DC 0,1W	237
<b>PRIZAT VE</b>		
VE10--XO	PRIZË SCHUKO 2P+E 16 A 250 V- XO	240
VE11--XO	PRIZË SCHUKO+KAPAK 2P+E 16 A 250 V- XO	240
VE12--XO	PRIZË SCHUKO 2P+E 16 A 250 V- BV XO	240
VE13--XO	PRIZË SCHUKO+POKROV 2P+E 16 A 250 V- BV XO	240
VE10--	PRIZË SCHUKO 2P+E 16 A 250 V-	240
VE11--	PRIZË SCHUKO+KAPAK 2P+E 16 A 250 V-	240
VE12--	PRIZË SCHUKO 2P+E 16 A 250 V- BV	240
VE13--	PRIZË SCHUKO+KAPAK 2P+E 16 A 250 V- BV	240
VE40--XO	PRIZË FRANCEZE 2P+E 16 A 250 V- XO	241
VE41--XO	PRIZË FRANCEZE+KAPAK 2P+E 16 A 250 V- XO	241
VE42--XO	PRIZË FRANCEZE 2P+E 16 A 250 V- BV XO	241
VE43--XO	PRIZË FRANCEZE+KAPAK 2P+E 16 A 250 V- BV XO	241
VE40--	PRIZË FRANCEZE 2P+E 16 A 250 V-	241
VE41--	PRIZË FRANCEZE+KAPAK 2P+E 16 A 250 V-	241
VE42--	PRIZË FRANCEZE 2P+E 16 A 250 V- BV	241
VE43--	PRIZË FRANCEZE+KAPAK 2P+E 16 A 250 V- BV	241
VE16--	PRIZË SCHUKO DYSHE 2P+E 16 A 250 V-	242
VE46--	PRIZË FRANCEZE DYSHE 2P+E 16 A 250 V-	242
VE30--	PRIZË 2P 16 A 250 V-	242
<b>KOMUNIKIMET KE</b>		
KE11	PRIZË TV-R ME KAPAK FUNDOR 1 dB	243
KE12	PRIZË TV-R KALUESE 10 dB	243
KE16	PRIZË SAT-TV-R ME KAPAK FUNDOR 3 dB	243
KE36	PRIZË TEL KS RJ11 6/4	243
KE37	PRIZË CAT5e KS RJ45 8/8	244
KE40	PRIZË CAT6s KS RJ45 8/8 E HOLLË	244
KE38	PRIZË TEL KS DYSHE 2x RJ11 6/4	244
KE39	PRIZË CAT5e KS DYSHE 2x RJ45 8/8	244
KE41	PRIZË CAT6s KS DYSHE 2x RJ45 8/8 E HOLLË	244
KE45	PËRSHTATËS KS NJËSH	244
KE46	PËRSHTATËS KS DYSH	245
KE47	PËRSHTATËS PD DYSH	245
KE10--	PRIZË TV BAZË 0 dB	246
KE11--	PRIZË TV-R ME KAPAK FUNDOR 1 dB	246
KE12--	PRIZË TV-R KALUESE 10 dB	246
KE16--	PRIZË SAT-TV-R ME KAPAK FUNDOR 3 dB	246
KE22--	PRIZË AUDIO 2xRCA	246
KE23--	PRIZË AUDIO PËR ALTOPARLANTË	246
KE36--	PRIZË TEL KS RJ11 6/4	246
KE37--	PRIZË CAT5e KS RJ45 8/8	247
KE40--	PRIZË CAT6s KS RJ45 8/8 E HOLLË	247
KE38--	PRIZË TEL KS DYSHE 2x RJ11 6/4	247
KE39--	PRIZË CAT5e KS DYSHE 2x RJ45 8/8	247
KE41--	PRIZË CAT6s KS DYSHE 2x RJ45 8/8 E HOLLË	247
KE35--	PRIZË TEL LT RJ11 6/4	247

kodi	Përshkrimi i produktit	faqe
<b>KAPAKËT PE</b>		
PE10--	KAPAK TV-R 2P/3P	248
PE20--	KAPAK KS NJËSH	248
PE21--	KAPAK KS DYSH	248
PE30--	KAPAK TAE/TDO	248
<b>LIDHJET ELEKTRONIKE EE</b>		
EE15	REOSTAT RROTULLUES ME 2 DREJTIME RL 400 W	249
EE16	REOSTAT RROTULLUES ME 2 DREJTIME RLC 400 W	249
EE19	REOSTAT RROTULLUES ME 2 DREJTIME LED 100 W	250
EE32	ÇELËS IR 5 A 230 V-	250
EE67	NJËSI USB E FURNIZIMIT ME ENERGJI 5 V 2,4 A	250
EE15--	REOSTAT RROTULLUES ME 2 DREJTIME RL 400 W	251
EE16--	REOSTAT RROTULLUES ME 2 DREJTIME RLC 400 W	251
EE19--	REOSTAT RROTULLUES ME 2 DREJTIME LED 100 W	251
EE32--	ÇELËS IR 5 A 230 V-	251
EE67--	NJËSI USB E FURNIZIMIT ME ENERGJI 5 V 2,4 A	252
EE68--	NJËSI USB E FURNIZIMIT ME ENERGJI 5 V 3,0 A	252
<b>KAPAK ELEKTRONIK PE</b>		
PE41--	REOSTAT ME KAPAK Ø6	254
PE32--	ÇELËS IR ME KAPAK	254
PE67--	KAPAK PËR NJËSINË USB TË FURNIZIMIT ME ENERGJI	254
<b>AKSESORËT AE</b>		
AE10--	TAPË	255
AE20--	KUTI LIDHJEJE 5-POLARE 3P+N+E 5x4mm2	255
AE30--	KUTI ME MONTIM NË SIPËRFAQE 1	255
AE31--	KUTI ME MONTIM NË SIPËRFAQE PËR PRIZË DYSHE EKONOMIK	255
AE50--	MBROJTJE PËR MURIN	256
AE51--	MBROJTJE PËR FËMIJËT KS	256
<b>RRETHUESE OE</b>		
OE10--	RRETHUES EKONOMIK 1	257
OE20--	RRETHUES EKONOMIK 2 HORIZONTAL	257
OE21--	RRETHUES EKONOMIK 2 VERTIKAL	257
OE30--	RRETHUES EKONOMIK 3 HORIZONTAL	257
OE31--	RRETHUES EKONOMIK 3 VERTIKAL	258
OE40--	RRETHUES EKONOMIK 4 HORIZONTAL	258
OE41--	RRETHUES EKONOMIK 4 VERTIKAL	258
OE50--	RRETHUES EKONOMIK 5 HORIZONTAL	258
OE90--	KORNIZA DEKORATIVE ME NGJYRA	258

**fontana**

kodi	Përshkrimi i produktit	faqe
<b>ÇELËSAT SF</b>		
SF10--	ÇELËS ME 1 DREJTIM IP44 10 AX 250 V-	262
SF10--TI	ÇELËS ME 1 DREJTIM IP44 10 AX 250 V- TI	262
SF11--TI	BUTON ME SHTYPJE ME 1 DREJTIM IP44 10 A 250 V- TI	262
SF20--	ÇELËS 2-POLAR IP44 10 AX 250 V-	262
SF50--	ÇELËS ME 2 VENDE ME 1 DREJTIM IP44 10 AX 250 V-	263
SF51--	BUTON ME SHTYPJE ME 2 VENDE ME 1 DREJTIM IP44 10 A 250 V-	263
SF60--	ÇELËS ME 2 DREJTIME IP44 10 AX 250 V-	263
SF60--TI	ÇELËS ME 2 DREJTIME IP44 10 AX 250 V- TI	263
SF63--	ÇELËS DYSH ME 2 DREJTIME 10 AX 250 V-	263
SF70--	ÇELËS NDËRMJETËS IP44 10 AX 250 V-	263
<b>PRIZAT VF</b>		
VF10--	PRIZË SCHUKO+KAPAK IP44 2P+E 16 A 250 V-	264
VF12--	PRIZË SCHUKO+KAPAK IP44 2P+E 16 A 250 V- BV	264
<b>SETET CF</b>		
CF10--	SET PRIZASH SCHUKO DYSHE HORIZONTALE IP44 2x2P+E 16 A 250 V-	265
CF11--	SET PRIZASH SCHUKO DYSHE VERTIKALE IP44 2x2P+E 16 A 250 V-	265
CF12--	PRIZË SCH+SET ÇELËSASH ME 2 DREJTIME HORIZONTALE IP44 16 A + 10 AX 250 V-	265
CF13--	PRIZË SCH+SET ÇELËSASH ME 2 DREJTIME VERTIKALE IP44 16 A + 10 AX 250 V-	266
CF14--	SET PRIZASH SCHUKO DYSHE HORIZONTALE IP44 2x 2P+E 16 A 250 V-BV	266
CF15--	SET PRIZASH SCHUKO DYSHE VERTIKALE IP44 2x 2P+E 16 A 250 V- BV	266
CF16--	PRIZË SCH+SET ÇELËSASH ME 2 DREJTIME HORIZONTALE IP44 16 A + 10 AX 250 V- BV	266
CF17--	PRIZË SCH+SET ÇELËS ME 2 DREJTIME VERTIKALE IP44 16 A + 10 AX 250 V- BV	266
<b>AKSESORËT AF</b>		
AF10--	KUTI SHPËRNDARJEJE IP44 RN01	267
AF20--	KUTI SHPËRNDARJEJE IP55 ND01	267







**TEM**

On/Off and everything in between

100% ELEKTRIČEN

www.tem.si

**TEM**

On/Off and everything in between



www





**TEM**

TEM ČATEŽ d.o.o.  
Čatež 13, 8212 VELIKA LOKA  
SLOVENIJA  
tem@tem.si  
www.tem.si

T +386(0)7 348 99 00

TEM

AL

[www.tem.si](http://www.tem.si)

